



Attila Kiss

Das awarenzeitliche Gräberfeld
in Kölked-Feketekapu B



Teil II

DAS AWARENZEITLICHE GRÄBERFELD
IN KÖLKED-FEKETEKAPU B

Teil II

MONUMENTA AVARORUM ARCHAEOLOGICA

Redigunt

É. Garam
et
T. Vida

Vol. 6

Budapest, 2001

ATTILA KISS

DAS AWARENZEITLICHE
GRÄBERFELD
IN KÖLKED-FEKETEKAPU B

mit 186 Abbildungen, 159 Tafeln, und VIII Farbtafeln

Teil II

Übersetzung: Albrecht Friedrich

Zeichnungen: Margit Szabados
Sándor Ósi

Photos: Zsuzsa Erdőkürti
András Dabasi

Dieser Band ist mit der Zuschuß

- der Staatlichen Stiftung der Wissenschaftlichen Forschung
(OTKA T 25615, RP 037102)
- des Ministeriums für Kulturerbe im Rahmen des Programms
„Kulturerbe Ungars“ (NÖP - 1999)
- des Janus Pannonius Museums, Pécs
erschieden.

ISBN 963-9046-55-8

ISSN 1219 2813

Herausgeber: Magyar Nemzeti Múzeum und
Magyar Tudományos Akadémia Régészeti Intézete, Budapest
Design und Druck-Vorbereitung: AD Grafikai Stúdió, Budapest
Druck: Kánai Nyomda

© Attila Kiss, 2001

INHALT

Teil I

VORWORT	11
EINLEITUNG	13
I. FUNDORT UND GRABUNGSGESCHICHTE	15
II. DIE BESCHREIBUNG DER GRÄBER	21
III. AUSWERTUNG	191
Grabgruppe I / 191	
1. Bestattungssitten / 191	
2. Fundanalyse / 192	
a) Trachtbestandteile / 192	
b) Waffen / 194	
c) Geräte / 194	
d) Gefäße / 194	
3. Belegung der Grabgruppe / 196	
4. Ethnizität der in der Grabgruppe Bestatteten / 197	
5. Chronologische Verhältnis der Grabgruppe und der awarenzeitlichen Siedlung / 197	
Grabgruppe II / 197	
1. Bestattungssitten / 197	
2. Fundanalyse / 198	
a) Trachtbestandteile / 198	
b) Keramik / 198	
3. Belegung der Grabgruppe / 198	
4. Ethnizität der in der Grabgruppe Bestatteten / 199	
Grabgruppe III / 199	
1. Bestattungssitten / 199	
2. Fundanalyse / 199	
3. Die Belegung der Grabgruppe und die Ethnizität der Bestatteten / 199	
4. Chronologisches Verhältnis der Grabgruppe und der awarenzeitlichen Siedlung / 199	
Grabgruppe IV / 199	
1. Bestattungssitten / 199	
2. Fundanalyse / 200	
a) Trachtbestandteile / 200	
3. Datierung und Belegung der Grabgruppe / 200	

4. Ethnizität der in der Grabgruppe Bestatteten / 200
 5. Chronologisches Verhältnis der Grabgruppe und der awarenzeitlichen Siedlung / 200
- Grabgruppe V / 201
1. Bestattungssitten / 201
 2. Fundanalyse / 202
 - a) Trachtbestandteile / 202
 - b) Waffen / 208
 - c) Geräte / 209
 - d) Gefäße / 210
 3. Chronologie / 210
 4. Belegung der Grabgruppe / 212
 5. Ethnizität der in der Grabgruppe Bestatteten / 213
 6. Die Glaubenswelt der in der Grabgruppe Bestatteten / 217
- Grabgruppe VI / 217
1. Bestattungssitten / 217
 2. Fundanalyse / 224
 - a) Trachtbestandteile / 224
 - b) Waffen / 236
 - c) Pferdegeschirr / 239
 - d) Gefäße / 251
 - e) Geräte / 251
 3. Belegung der Grabgruppe / 255
 4. Absolute Chronologie der Grabgruppe / 256
 5. Ethnizität der in der Grabgruppe Bestatteten / 256
 6. Demographie / 257
 7. Chronologisches Verhältnis der Grabgruppe und der awarenzeitlichen Siedlung / 257
- Grabgruppe VII / 257
1. Bestattungssitten / 257
 2. Fundanalyse / 258
 - a) Trachtbestandteile / 258
 - b) Geräte / 260
 3. Chronologische Stellung von Grab B-173 / 261
 4. Ethnizität der in Grab B-173 Bestatteten / 261
 5. Chronologisches Verhältnis der Grabgruppe und der awarenzeitlichen Siedlung / 262
- Grabgruppe VIII / 262
1. Bestattungssitten und Auswertung / 262
- Grabgruppe IX / 262
1. Bestattungssitten / 262
 2. Fundanalyse / 266
 - a) Trachtbestandteile / 266
 - b) Waffen / 321

- c) Pferdegeschirr / 327
- d) Gefäße / 327
- e) Geräte und Werkzeug / 332
- f) Münzen / 333
- g) Möbel / 334
- h) Haushaltsgerät / 334
- i) Musikinstrument / 335
- 3. Chronologie der Gegenstände und Belegung der Grabgruppe / 335
- 4. Ethnizität der in der Grabgruppe Bestatteten / 345
- 5. Die „fehlenden“ Gräber der Grabgruppe IX / 346
- 6. Chronologisches Verhältnis der Grabgruppe und der awarenzeitlichen Siedlung / 348
- Grabgruppe X / 349
 - 1. Bestattungssitten / 349
 - 2. Fundanalyse / 349
 - a) Trachtbestandteile / 349
 - b) Waffen / 349
 - c) Geräte / 349
 - d) Gefäße / 349
 - 3. Chronologie und Belegung der Grabgruppe / 350
 - 4. Ethnizität der in der Grabgruppe Bestatteten / 350
- Grabgruppe XI / 350
 - 1. Bestattungssitten / 350
 - 2. Fundanalyse / 350
 - a) Trachtbestandteile / 350
 - b) Gefäße / 351
 - 3. Chronologie und Belegung der Grabgruppe / 351
 - 4. Ethnizität der in der Grabgruppe Bestatteten / 351
 - 5. Chronologisches Verhältnis der Grabgruppe und der awarenzeitlichen Siedlung / 351
- Grabgruppe XII/A / 351
 - 1. Bestattungssitten / 351
 - 2. Fundanalyse / 360
 - a) Trachtbestandteile / 360
 - b) Waffen / 363
 - c) Pferdegeschirr / 363
 - d) Gefäße / 364
 - e) Geräte / 364
 - 3. Belegung der Grabgruppe / 366
 - 4. Absolute Chronologie der Grabgruppe / 368
 - 5. Ethnizität der in der Grabgruppe Bestatteten / 368
 - 6. Chronologisches Verhältnis der Grabgruppe und der awarenzeitlichen Siedlung / 368
- Grabgruppe XII/B / 368

1. Bestattungssitten / 368
 2. Fundanalyse / 369
 - a) Trachtbestandteile / 369
 - b) Waffen / 370
 - c) Geräte / 371
 - d) Gefäße / 372
 3. Chronologische Stellung der Grabgruppe / 373
 4. Belegung der Grabgruppe / 373
 5. Ethnizität der in der Grabgruppe Bestatteten / 373
 - Grabgruppe XIII / 374
 1. Bestattungssitten / 374
 2. Fundanalyse / 376
 - a) Trachtbestandteile / 376
 - b) Geräte / 376
 - c) Gefäße / 376
 3. Chronologie und Belegung der Grabgruppe / 376
 4. Ethnizität der in der Grabgruppe Bestatteten / 377
 - Grabgruppe XIV / 377
 1. Bestattungssitten / 377
 2. Fundanalyse / 377
 - a) Trachtbestandteile / 377
 - b) Gefäße / 378
 3. Datierung der Grabgruppe / 378
 4. Ethnizität der in der Grabgruppe Bestatteten / 378
 5. Chronologisches Verhältnis der Grabgruppe und der awarenzeitlichen Siedlung / 378
 - Grabgruppe XV / 378
 1. Bestattungssitten / 378
 2. Fundanalyse / 379
 3. Datierung der Grabgruppe / 379
 4. Ethnizität der in der Grabgruppe Bestatteten / 379
 - Grabgruppe XVI / 379
 1. Bestattungssitten / 379
 2. Fundanalyse / 379
 - a) Trachtbestandteile / 379
 - b) Waffen / 380
 - c) Gefäße / 380
 3. Absolute Chronologie der Grabgruppe / 380
 4. Ethnizität der in der Grabgruppe Bestatteten / 380
- IV. DIE GESELLSCHAFT DER IN DEN GRABGRUPPEN
VON KÖLKED-FEKETEKAPU GRÄBERFELD B BESTATTETEN / 381

I N H A L T

V.	GLAUBENSWELT DER IN DEN FRÜHEN GRUPPEN VON KÖLKED-FEKETEKAPU GRÄBERFELD B BESTATTETEN	391
VI.	CHRONOLOGISCHER UND ETHNISCHER VERGLEICH DER GRABGRUPPEN VON KÖLKED-FEKETEKAPU A UND B	393
	1. Chronologische Verteilung und Vergleich der Grabgruppen von Kölked-Feketekapu Gräberfeld A und B	/ 393
	2. Ethnische Bestimmung der in den Grabgruppen von Kölked-Feketekapu Gräberfeld A und B Bestatteten und der Vergleich der Grabgruppen	/ 395
VII.	DIE STELLUNG VON KÖLKED-FEKETEKAPU GRÄBERFELD B IN DER FRÜHAWARENZEIT OSTPANNONIENS	403
	1. Beziehungen der Bevölkerungen der Gräberfelder von Kölked-Feketekapu	/ 403
	2. Die wirtschaftliche, kulturelle und politische Stellung der ostpannonischen frühawarenzeitlichen Germanen/Gepidensiedlungen im Awarenkhanat	/ 403
VIII.	DIE SPÄTAWARENZEITLICHEN GRÄBERFELDER VON KÖLKED-FEKETEKAPU UND DIE SIEDLUNGSGESCHICHTE DES KOMITATS BARANYA IM 9-11. JAHRHUNDERT	407
	ANMERKUNGEN	409
	BIBLIOGRAPHIE	427
	ABKÜRZUNGEN	469

Teil II

Tafeln 1-22 / Photos der Gräber	/ 11
Tafeln 23-101 / Zeichnungen der Grabfunde	/ 35
Tafeln 102-159 / Photos der Grabfunde	/ 117
Farbtafeln I-VIII	/ 197

TAFELN 1-22

PHOTOS DER GRÄBER

TAFEL 12
PHOTOS DER GRABER



Taf. 1 1: Grab 66; 2: Grab 82; 3-4: Grab 80

KÖLKED – FEKETE KAPU B



Taf. 2 1-2, 4: Grab 85; 3: Grab 88

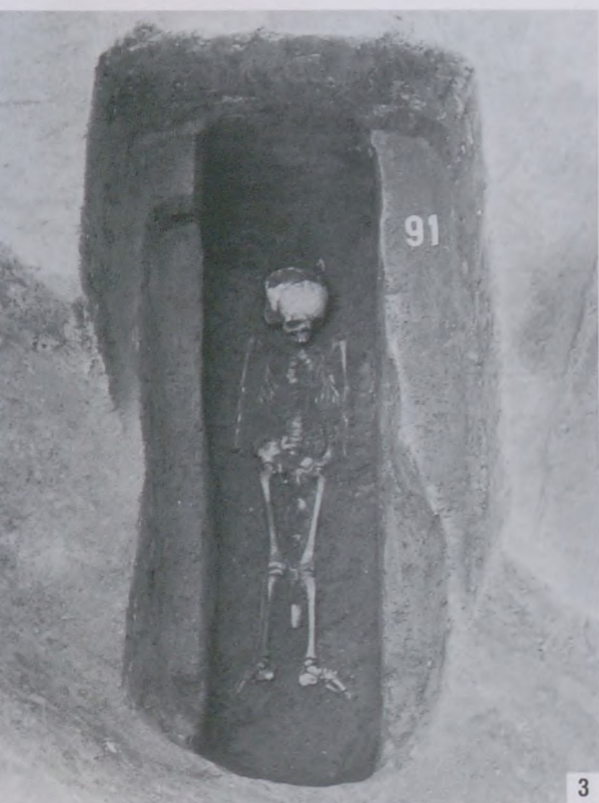
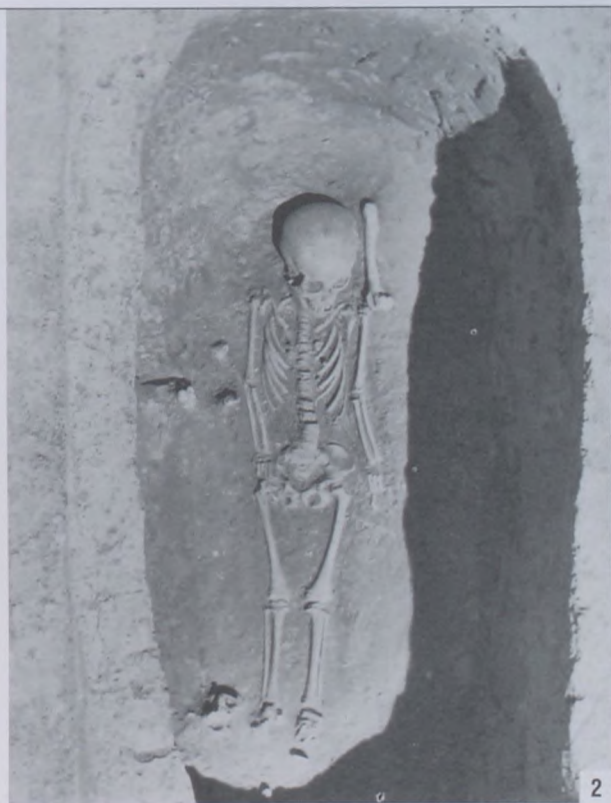

Taf. 3 1-2: Grab 87; 3: Grab 91; 4: Grab 106



Taf. 4 1: Grab 93; 2: Grab 132; 3: Grab 135

KÖLKED – FEKETE KAPU B

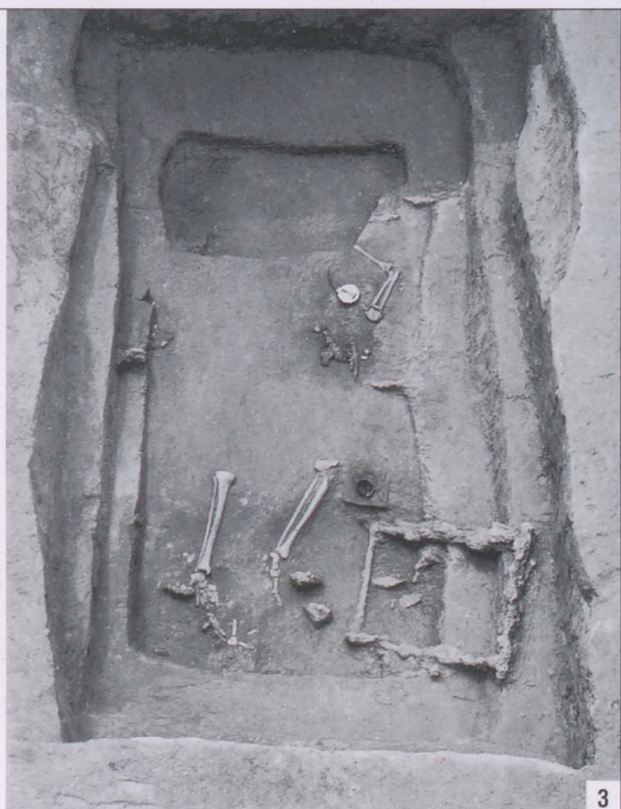

Taf. 5 1-3: Grab 119

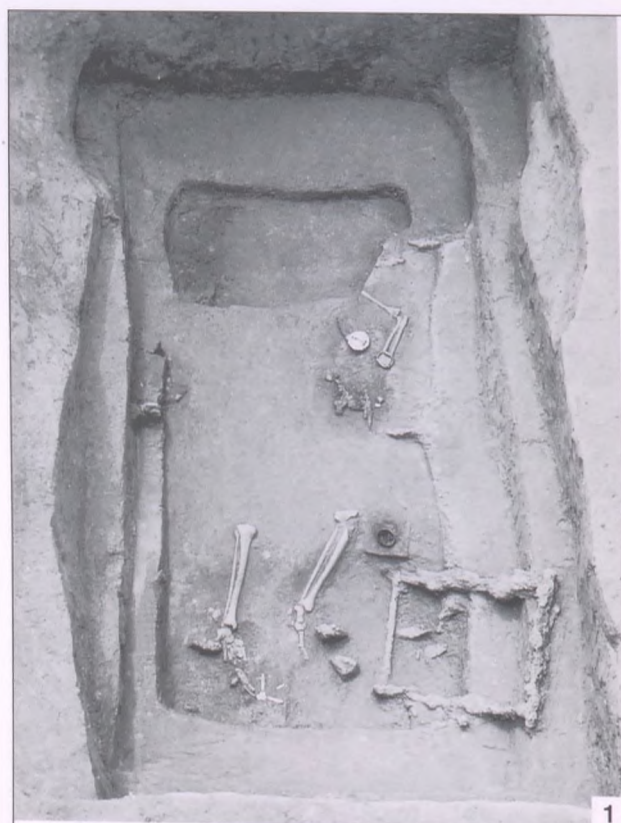

Taf. 6 1-3: Grab 119

KÖLKED – FEKETEKAJU B



Taf. 7 1-2: Grab 119; 3: Grab 166

KÖLKED – FEKETE KAPU B

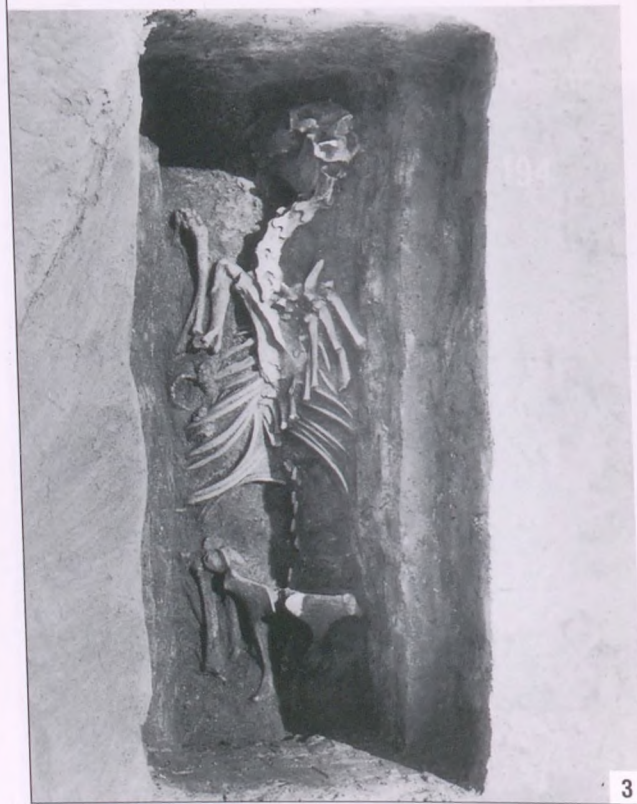

Taf. 8 1-2: Grab 173; 3: Grab 194; 4: Grab 197

KÖLKED – FEKETEKAPOU B

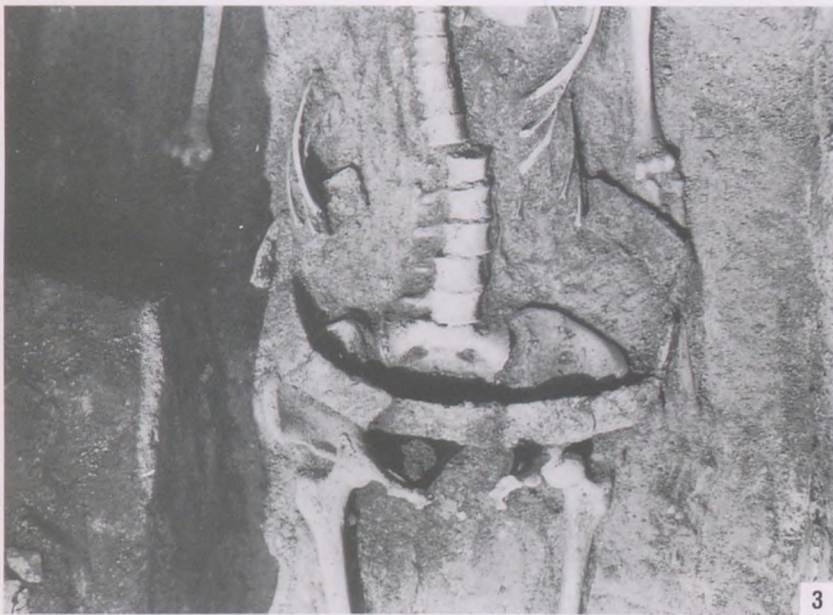
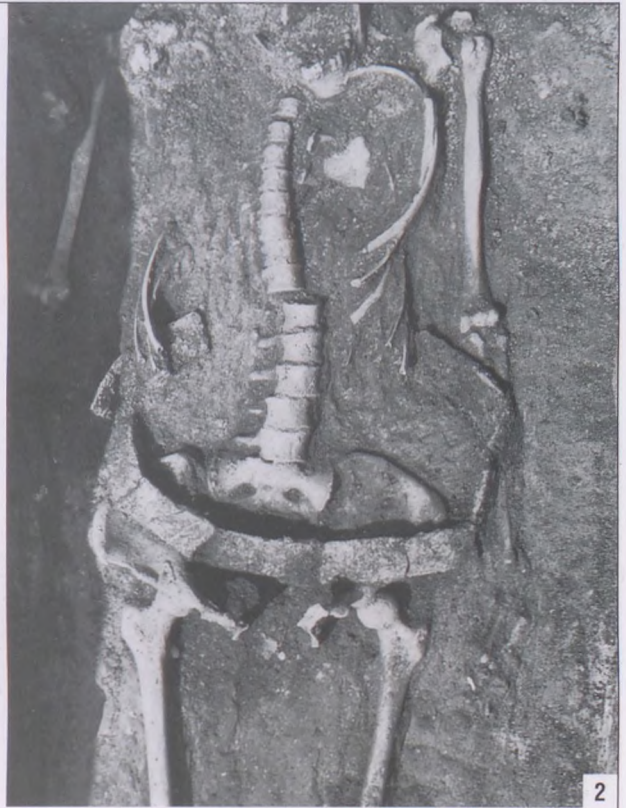

Taf. 9 1-3: Grab 181

KÖLKED – FEKETEKAJU B

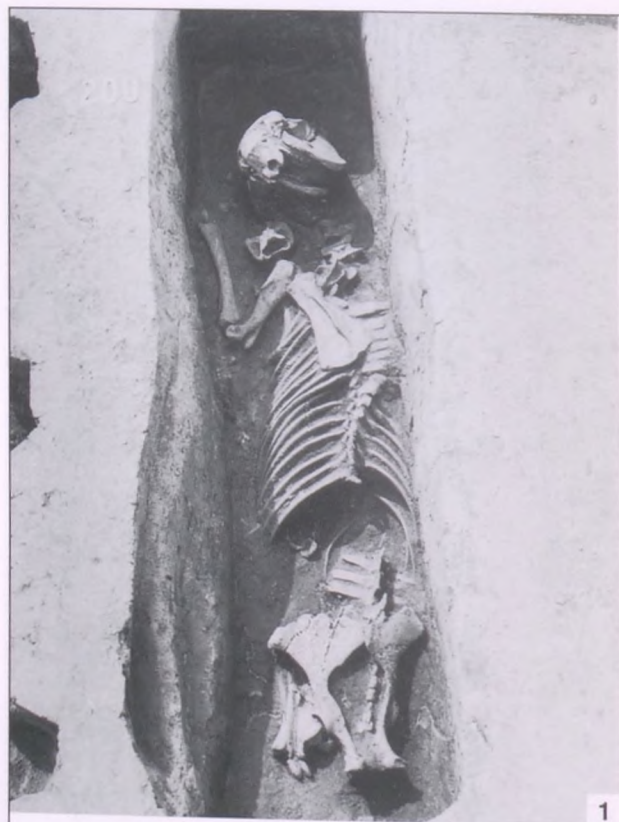

Taf. 10 1: Grab 200; 2: Grab 202; 3-4: Grab 215

KÖLKED – FEKETEKAPO B



Taf. 11 1: Gräber 209-210; 2: Grab 210; 3: Grab 209

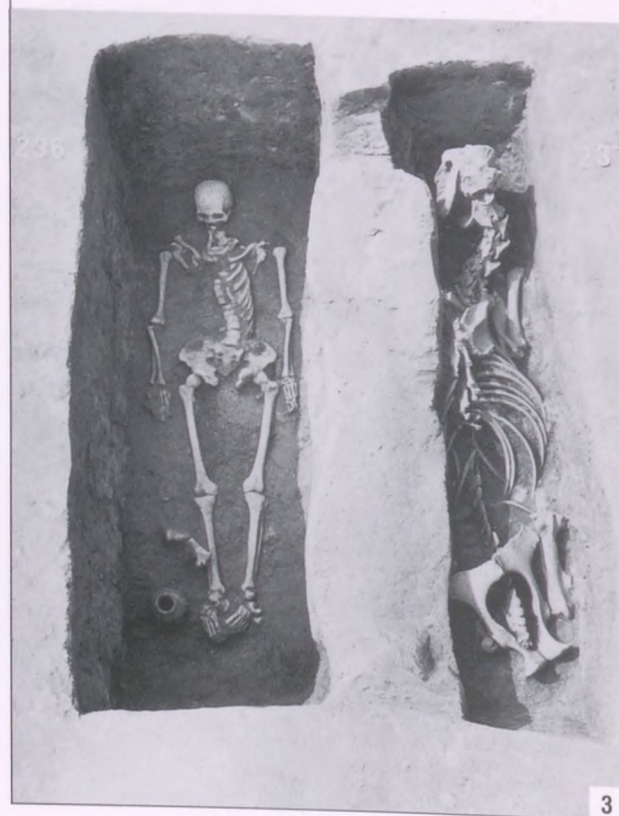

Taf. 12 1-2: Grab 220; 3: Gräber 236-237; 4: Grab 301

KÖLKED – FEKETEKAPU B



Taf. 13 1-2 Grab 229; 3: Grab 330; 4: Grab 336



Taf. 14 1-2: Grab 343; 3-4: Grab 346



Taf. 15 1: Grab 353; 2: Grab 354; 3: Grab 366; 4: Grab 413



Taf. 16 1-2: Grab 419; 3-4: Grab 427

KÖLKED – FEKETEKAPO B



Taf. 17 1: Grab 428; 2: Grab 431; 3-4: Grab 438

KÖLKED – FEKETE KAPU B



Taf. 18 1-3: Grab 449

KÖLKED – FEKETEKAPU B



Taf. 19 1: Grab 443; 2: Grab 459; 3: Grab 470; 4: Grab 495

KÖLKED – FEKETEKAPU B

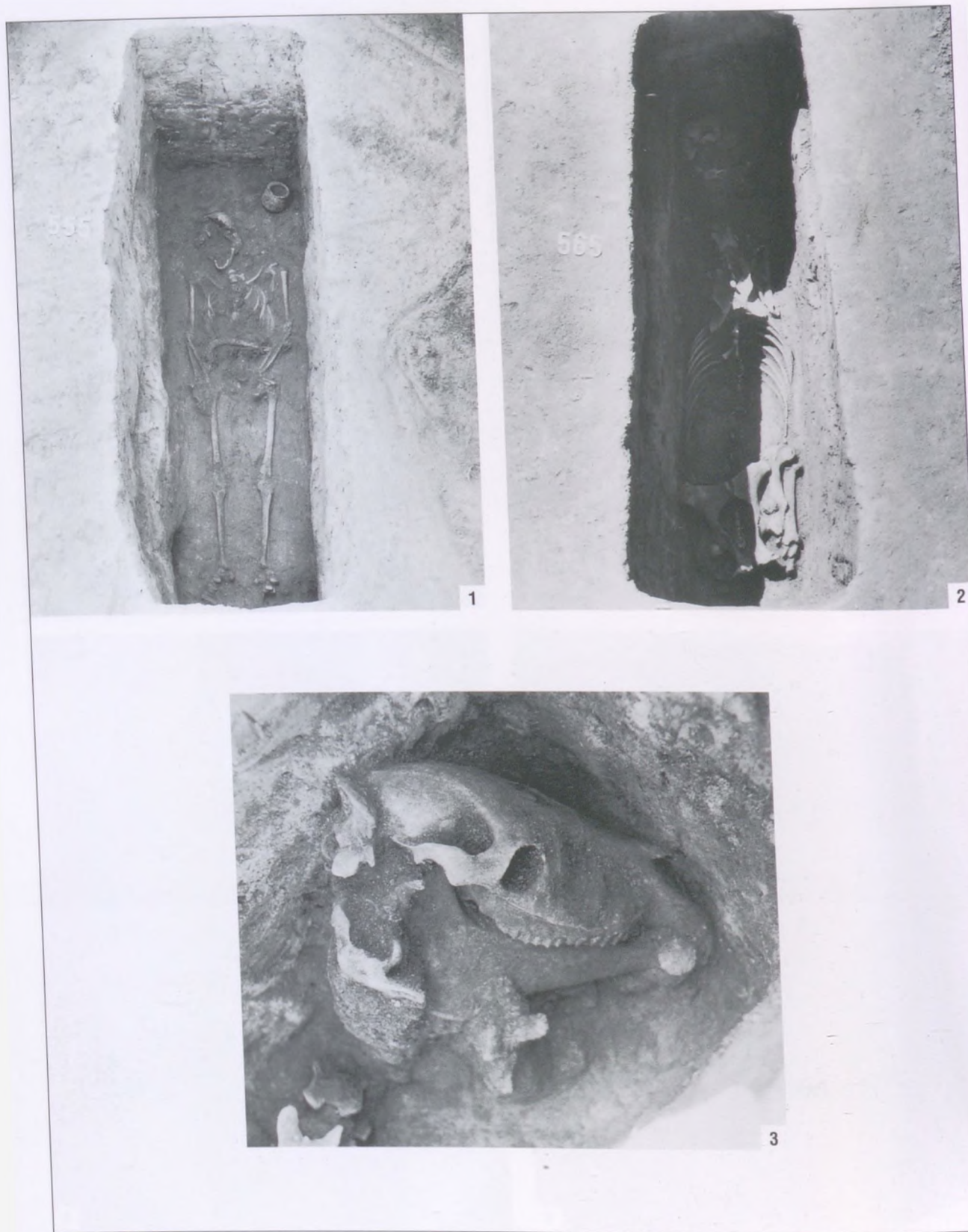

Taf. 20 1: Grab 555; 2: Grab 564; 3: Grab 565

KÖLKED – FEKETEKAPOU B



Taf. 21 1: Grab 569; 2: Grab 570; 3: Grab 572; 4: Grab 573

KÖLKED – FEKETE KAPU B

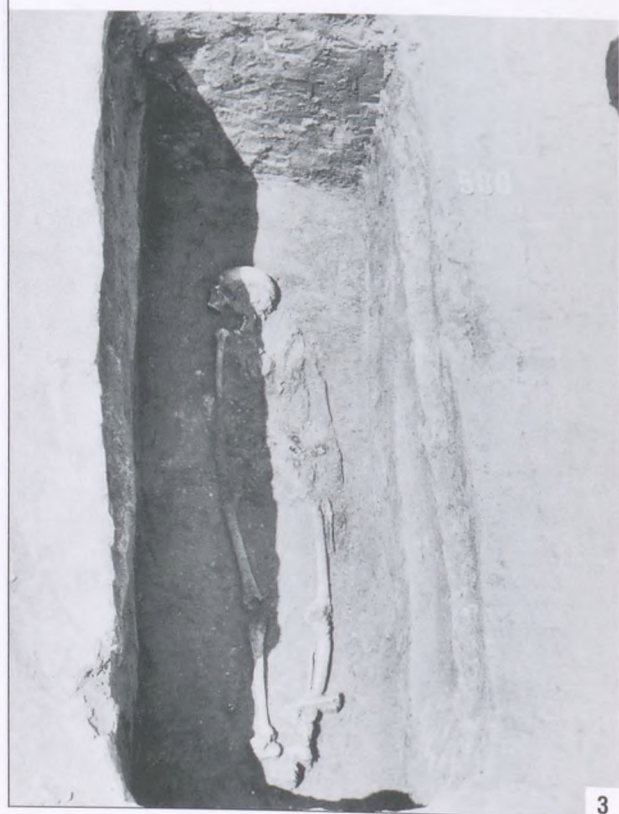

Taf. 22 1-2: Grab 577; 3: Grab 580; 4: Grab 581

TAFELN 23-101

ZEICHNUNGEN DER GRABFUNDE

KÖLKED – FEKETEKAJU B

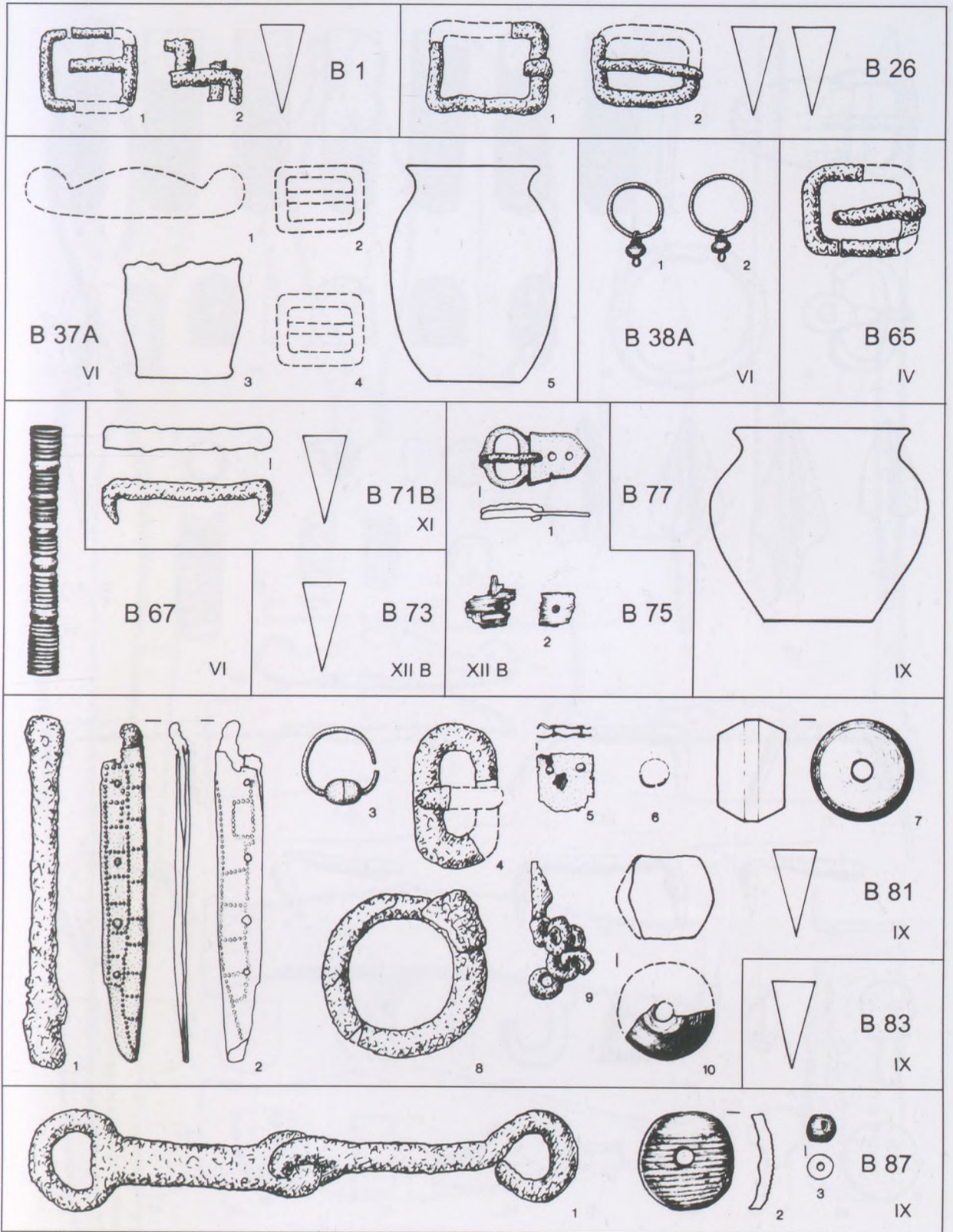

Taf. 23 Gräber 1, 26, 37/A, 38/A, 65, 67, 71/B, 73, 75, 77, 81, 83, 87

KÖLKED - FEKETEKAJU B

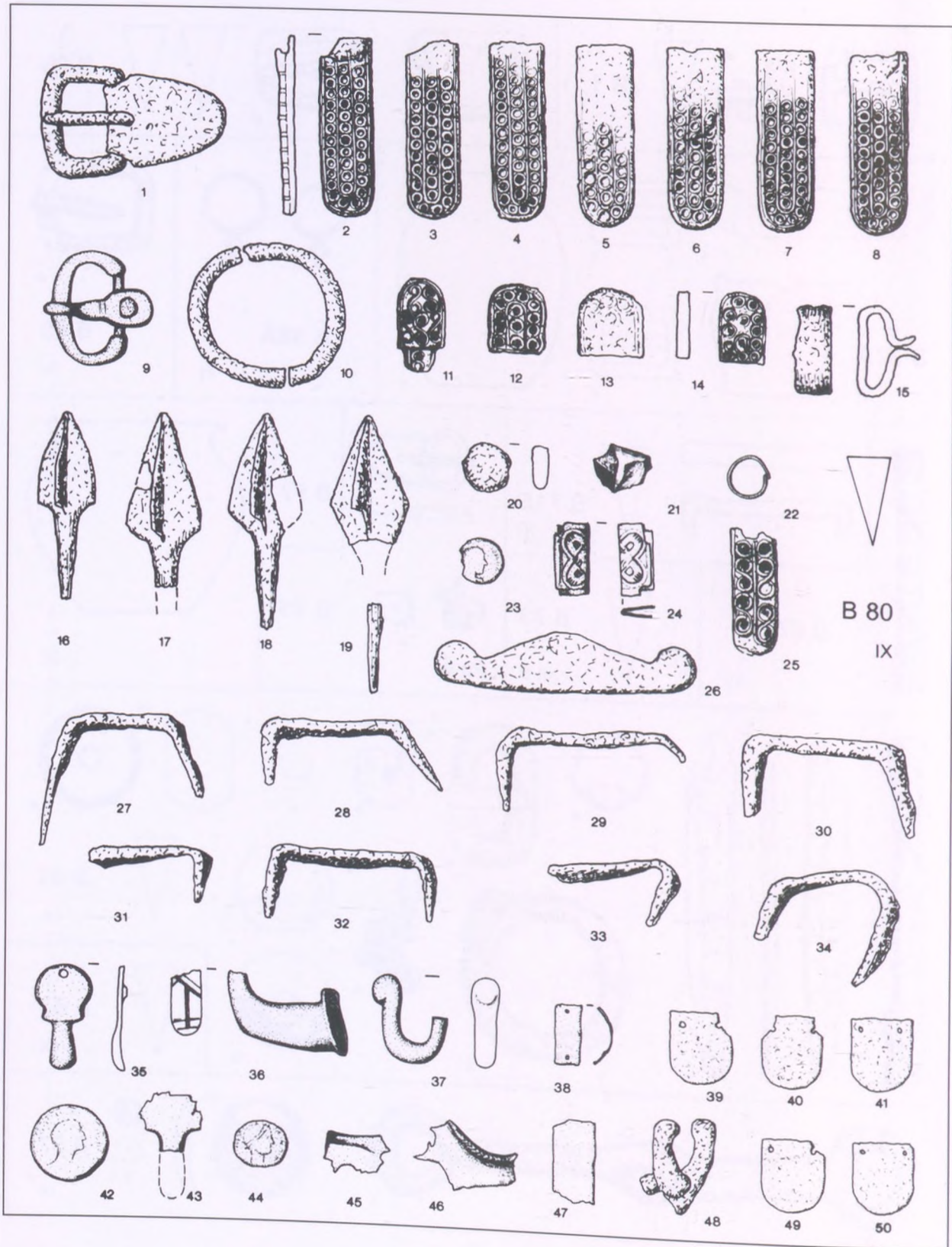

Taf. 24 Grab 80

KÖLKED - FEKETEKAJU B

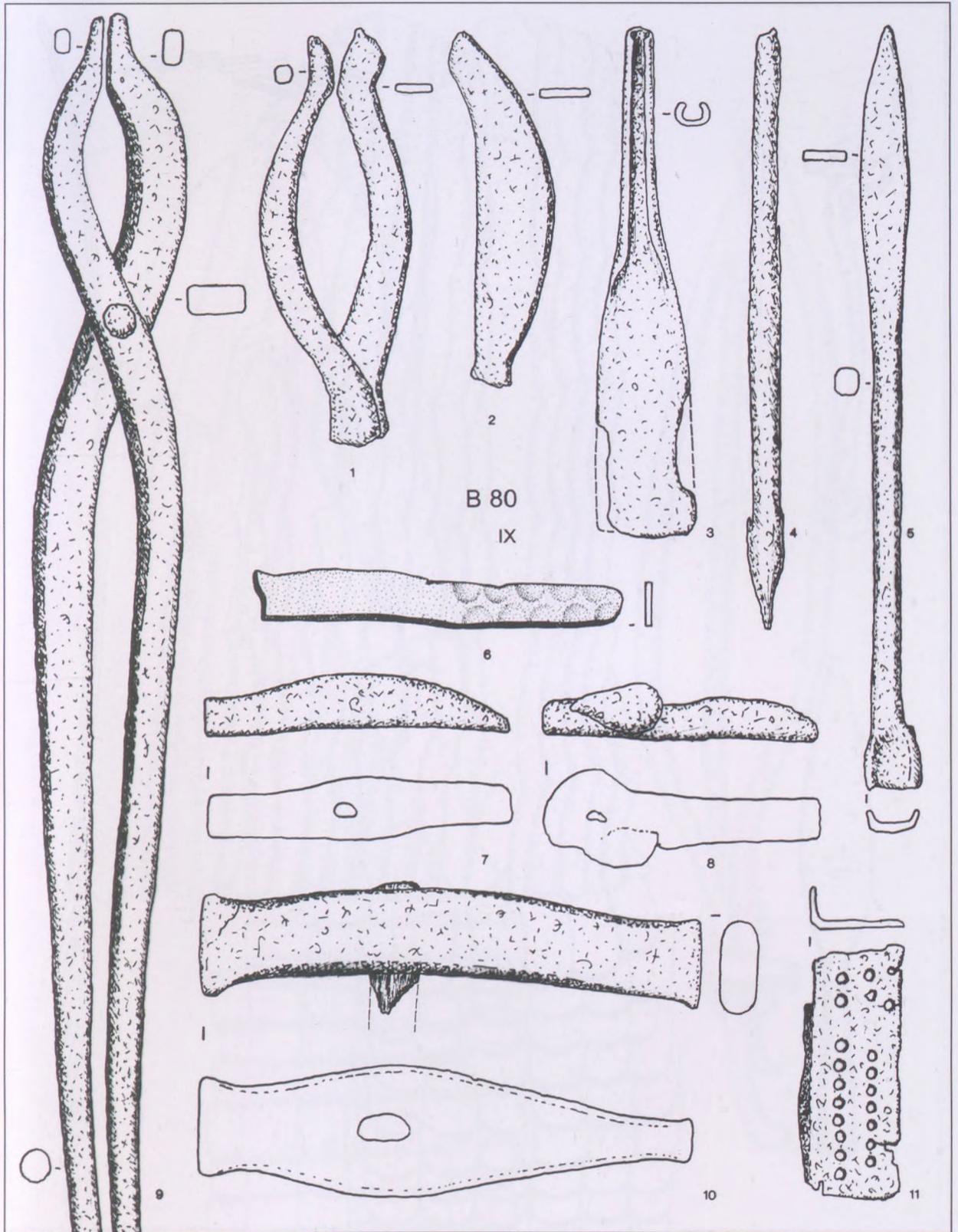

Taf. 25 Grab 80

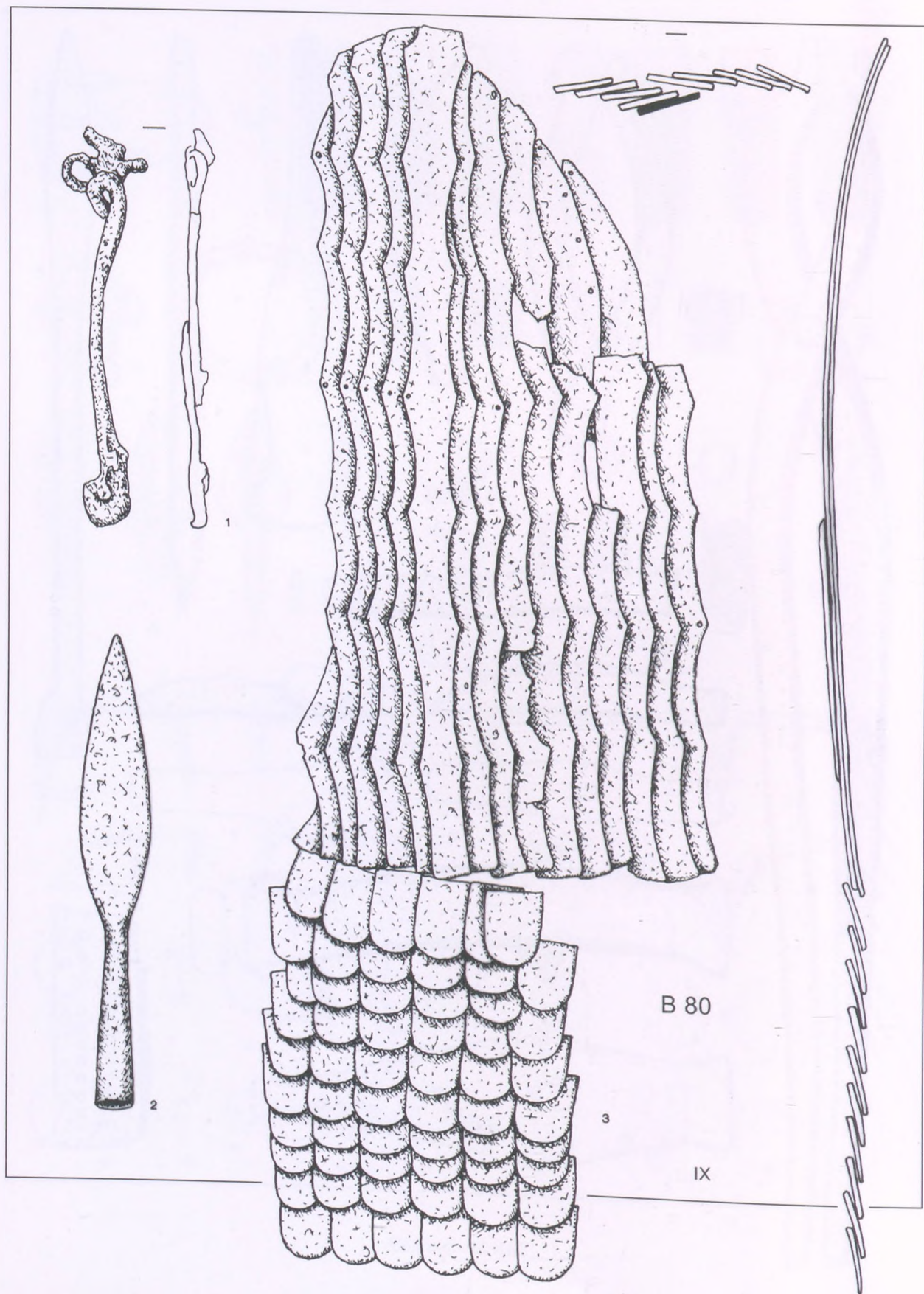

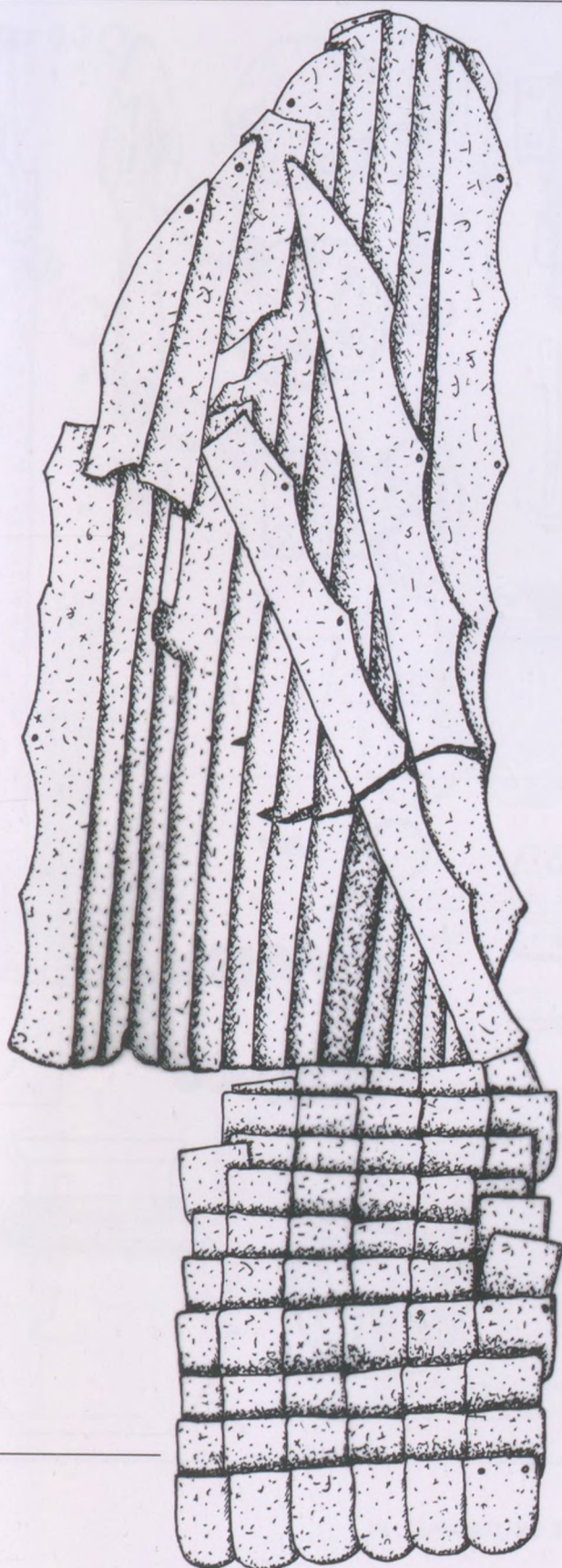

B 80

IX

KÖLKED – FEKETEKAPO B

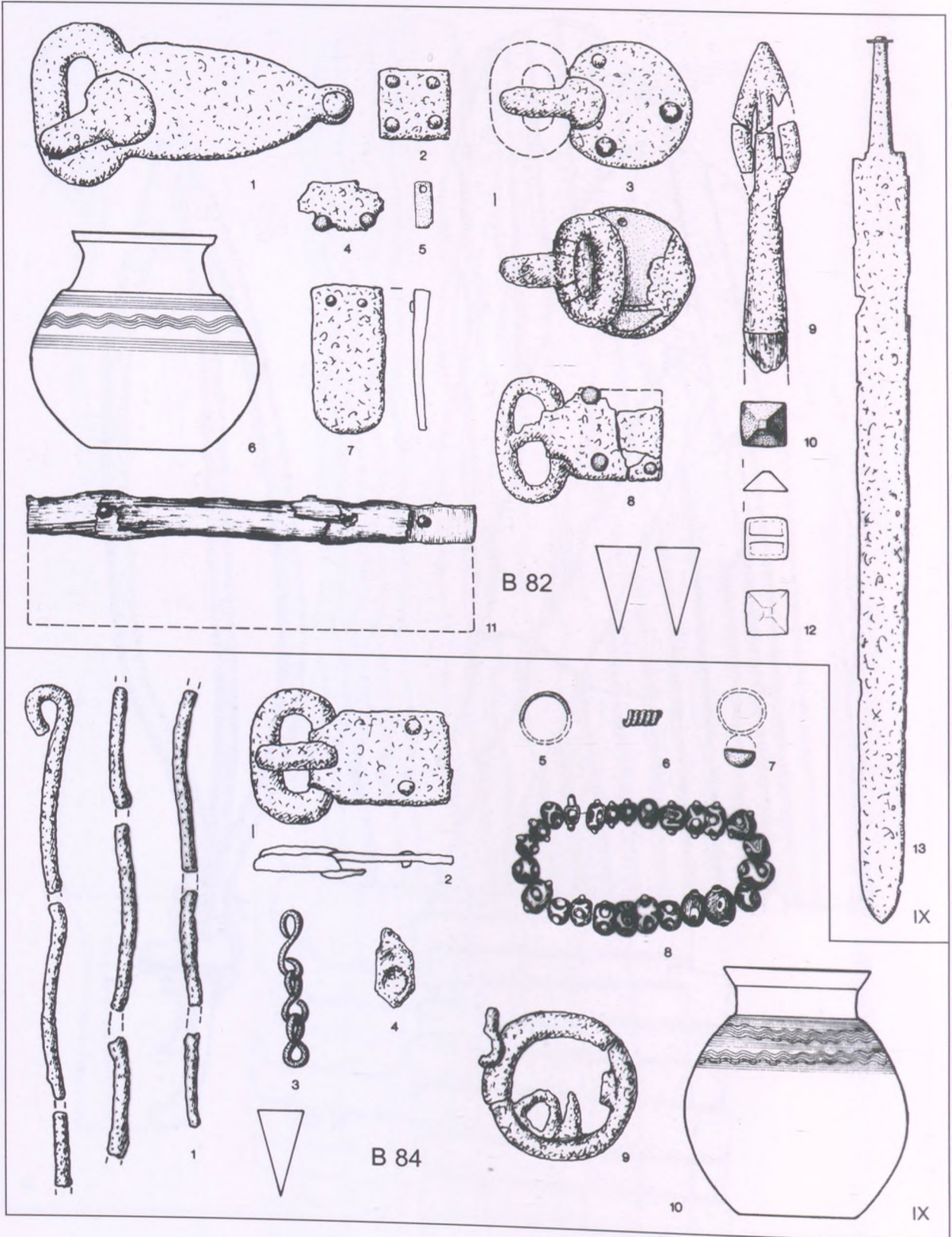

Taf. 28 Gräber 82, 84

KÖLKED – FEKETEKAJU B

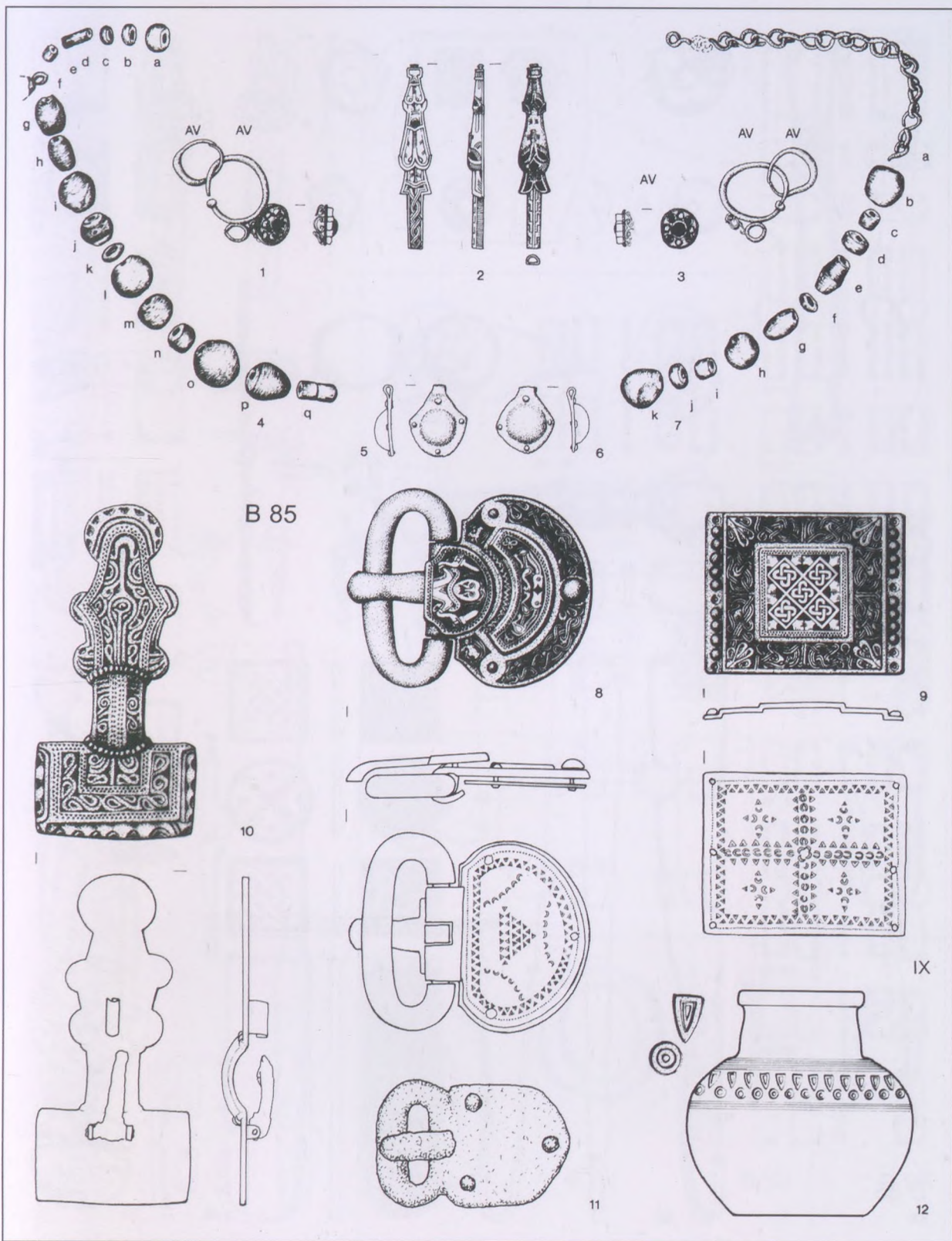

Taf. 29 Grab 85

KÖLKED – FEKETEKAJU B

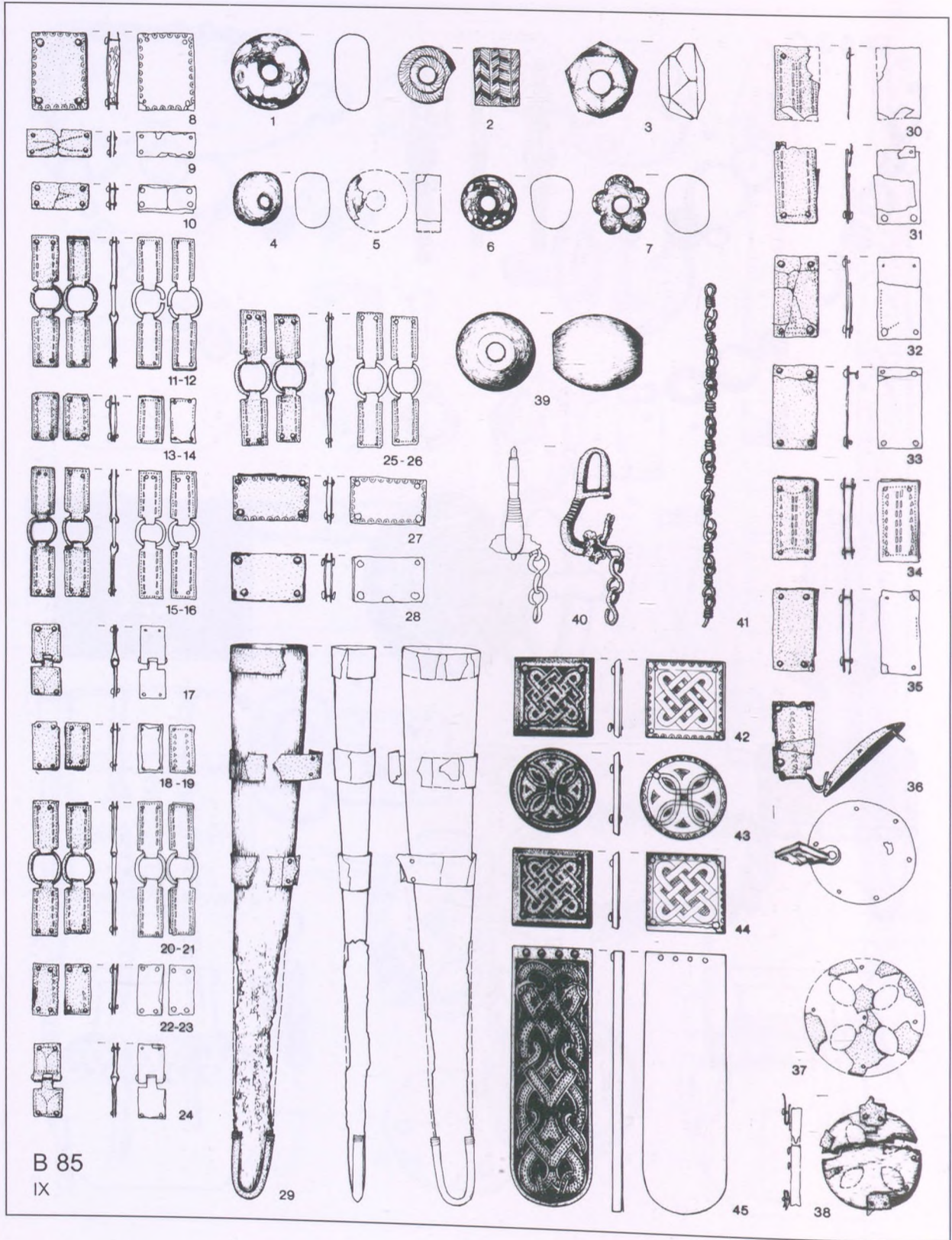

Taf. 30 Grab 85

KÖLKED - FEKETEKAPO B

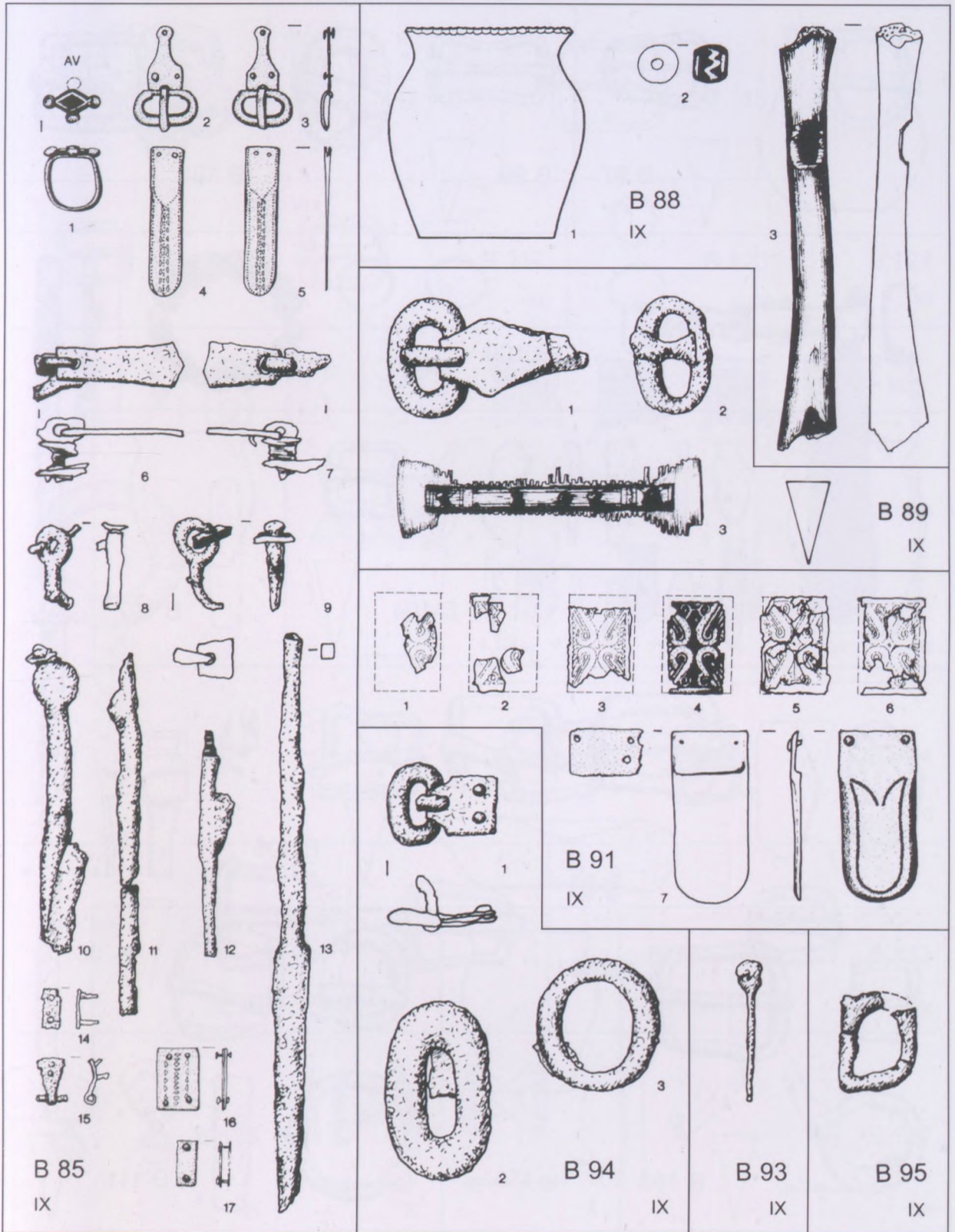

Taf. 31 Gräber 85, 88, 89, 91, 93, 94, 95

KÖLKED – FEKETEKAJU B

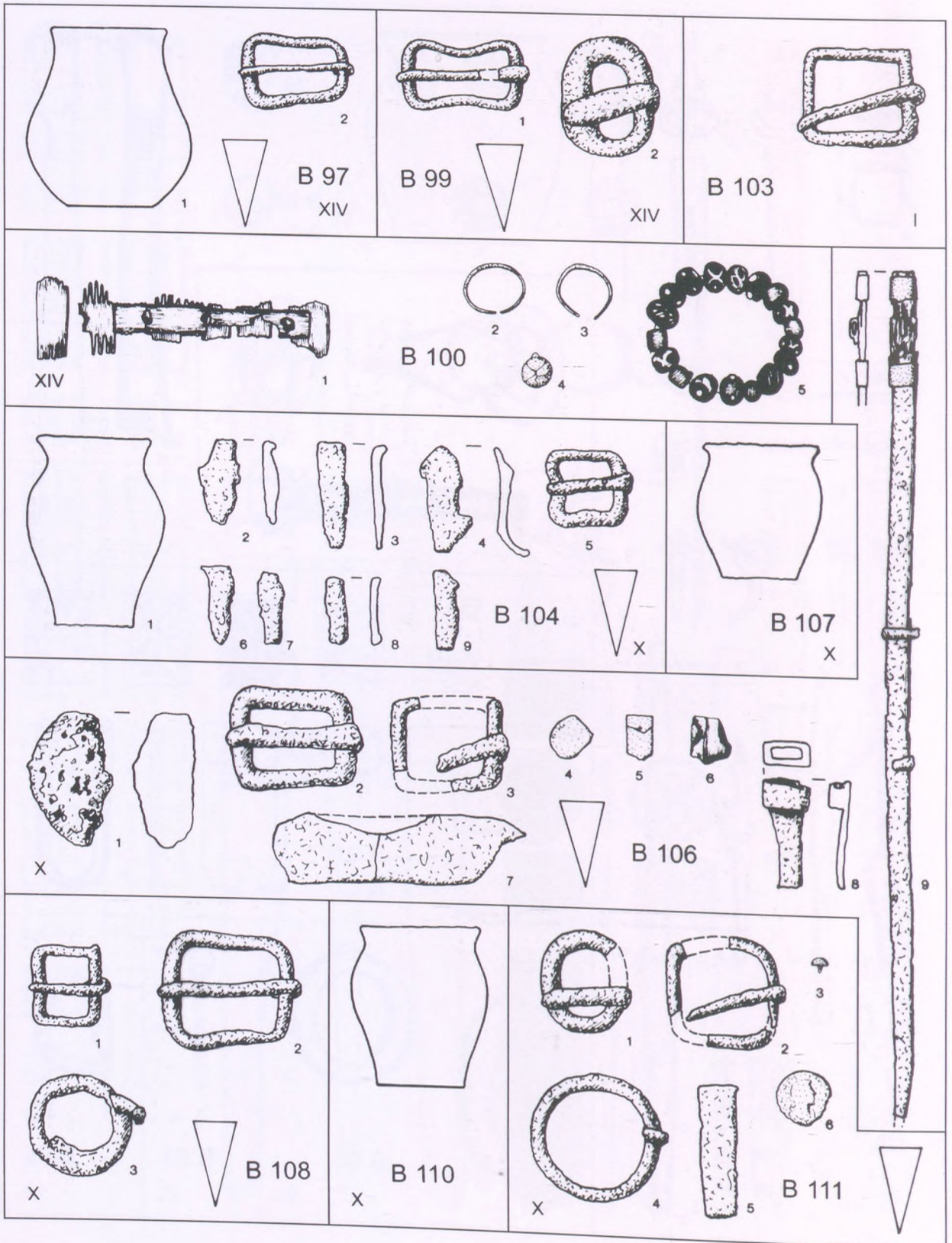

Taf. 32 Gräber 97, 99, 100, 103, 104, 106, 107, 108, 110, 111

KÖLKED – FEKETEKAPO B

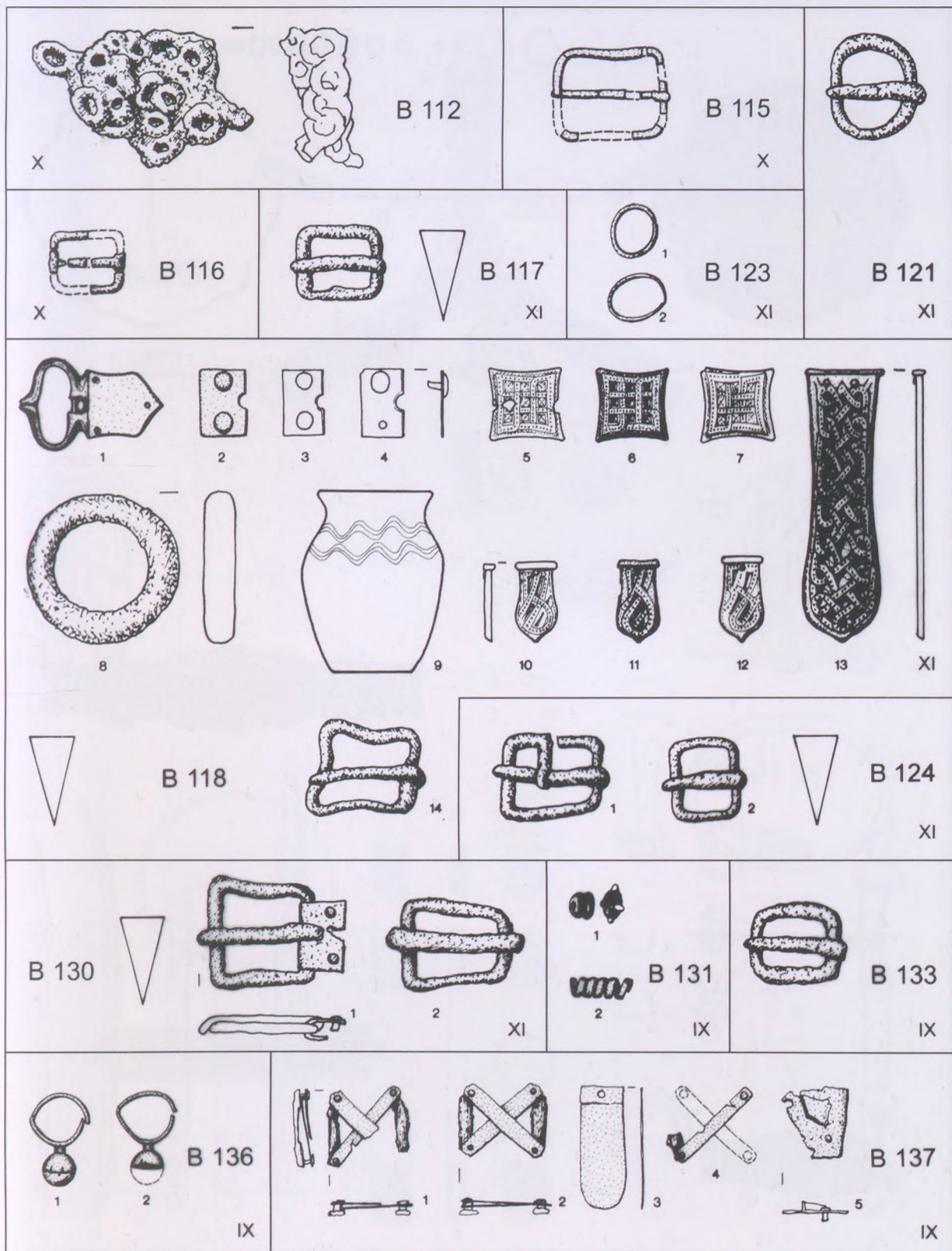

Taf. 33 Gräber 112, 115, 116, 117, 118, 121, 123, 124, 130, 131, 133, 136, 137

KÖLKED – FEKETE KAPU B

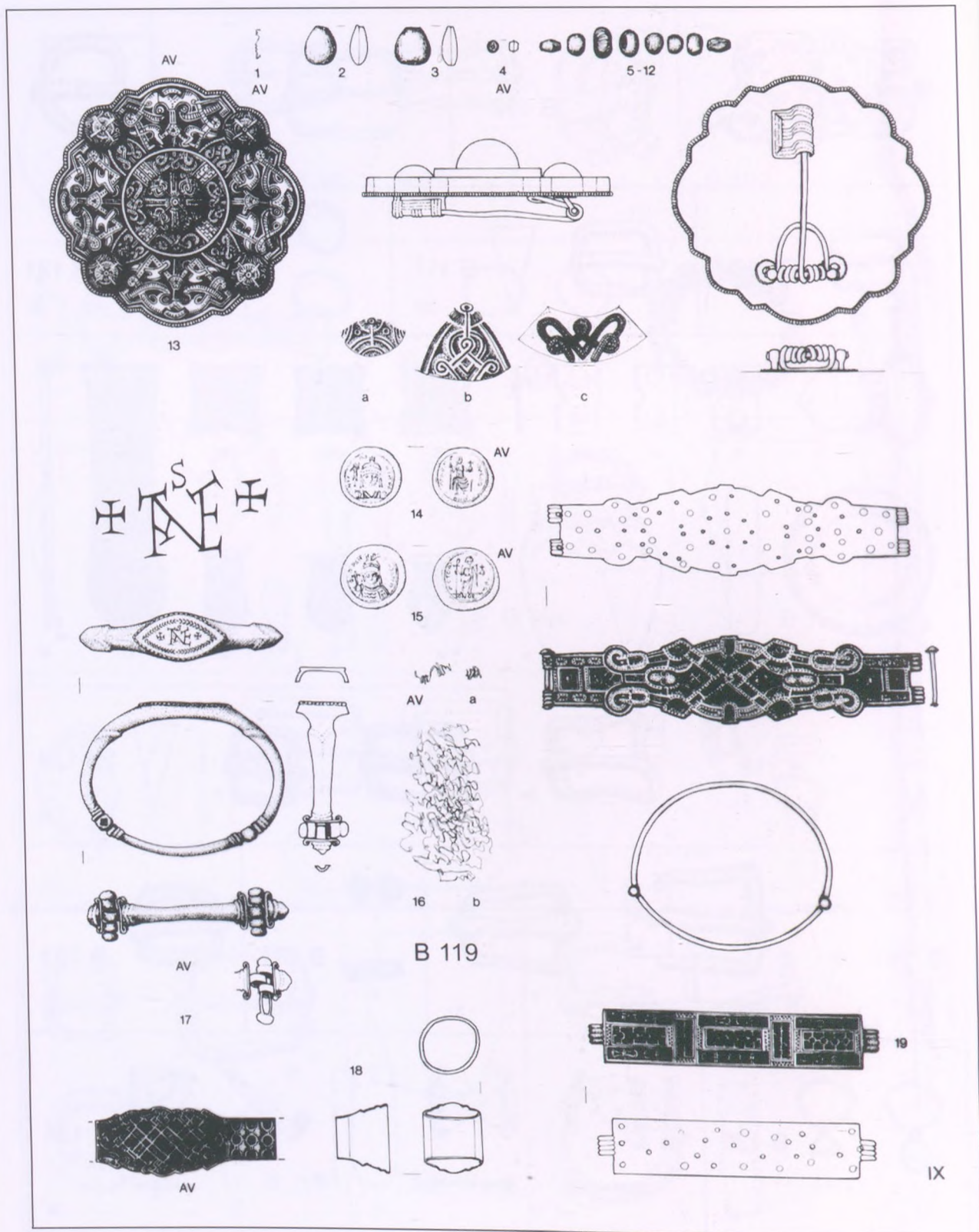

Taf. 34 Grab 119

KÖLKED – FEKETEKAPU B

B 119

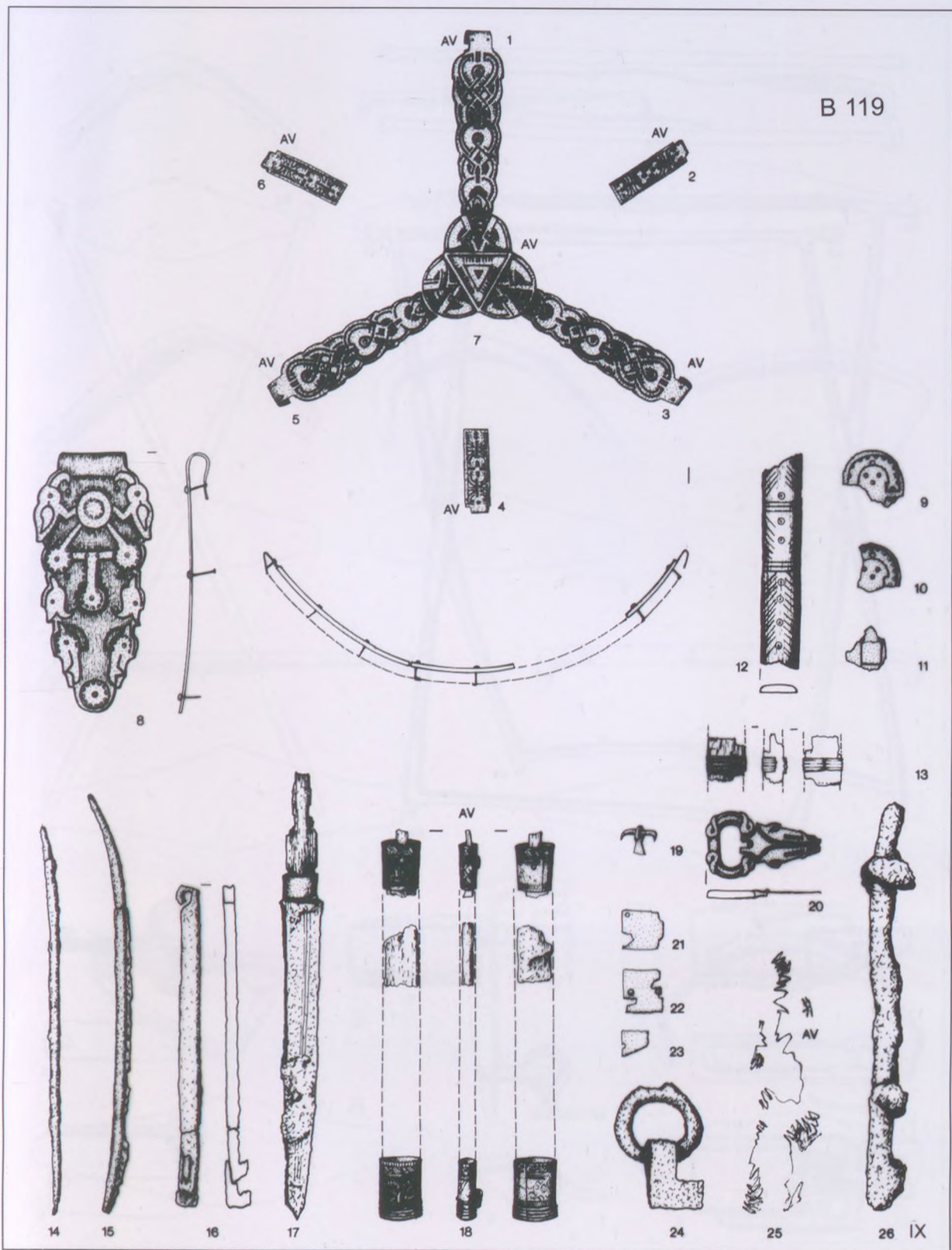

Taf. 35 Grab 119

KÖLKED – FEKETE KAPU B

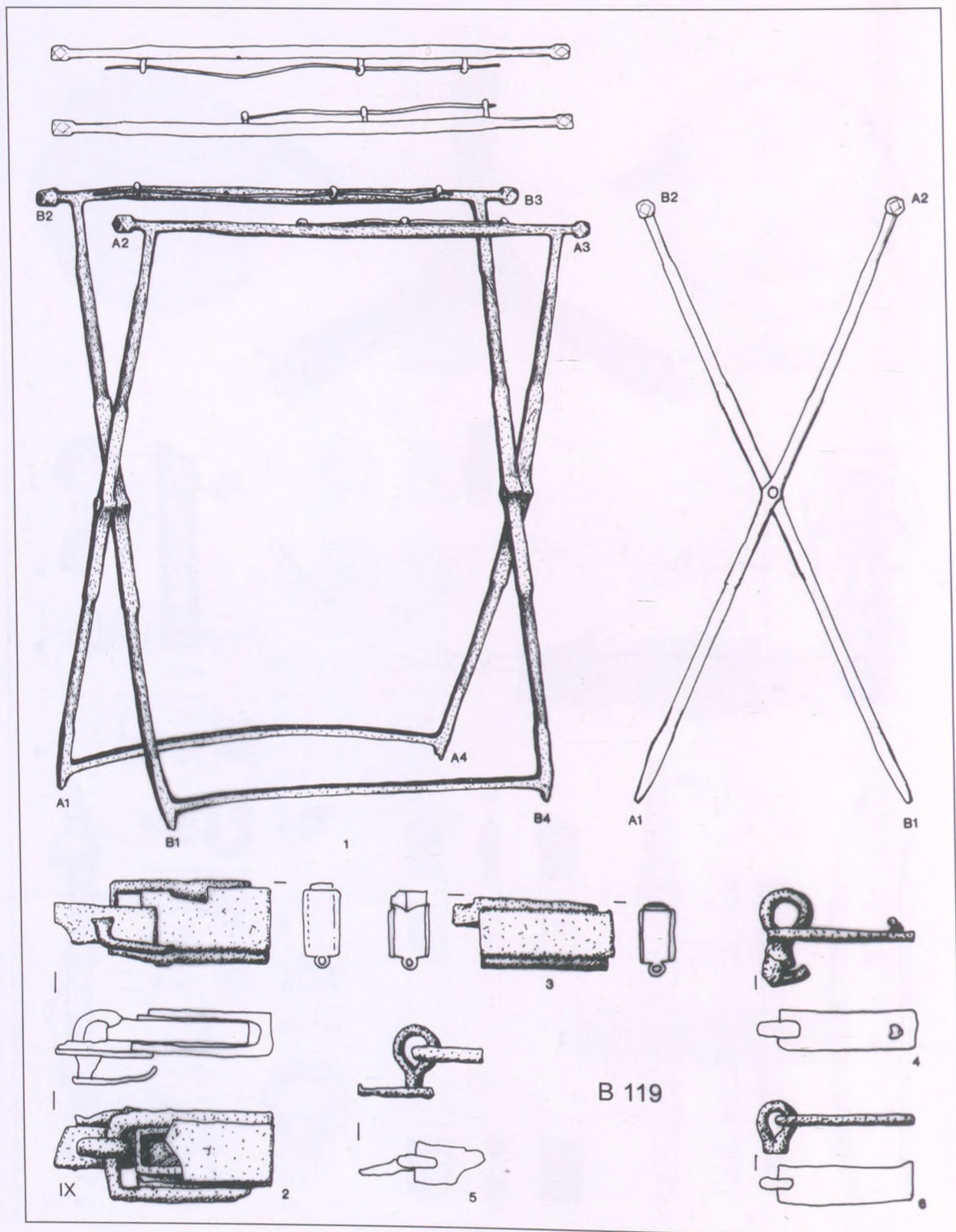

B 119

Taf. 36 Grab 119

KÖLKED – FEKETE KAPU B

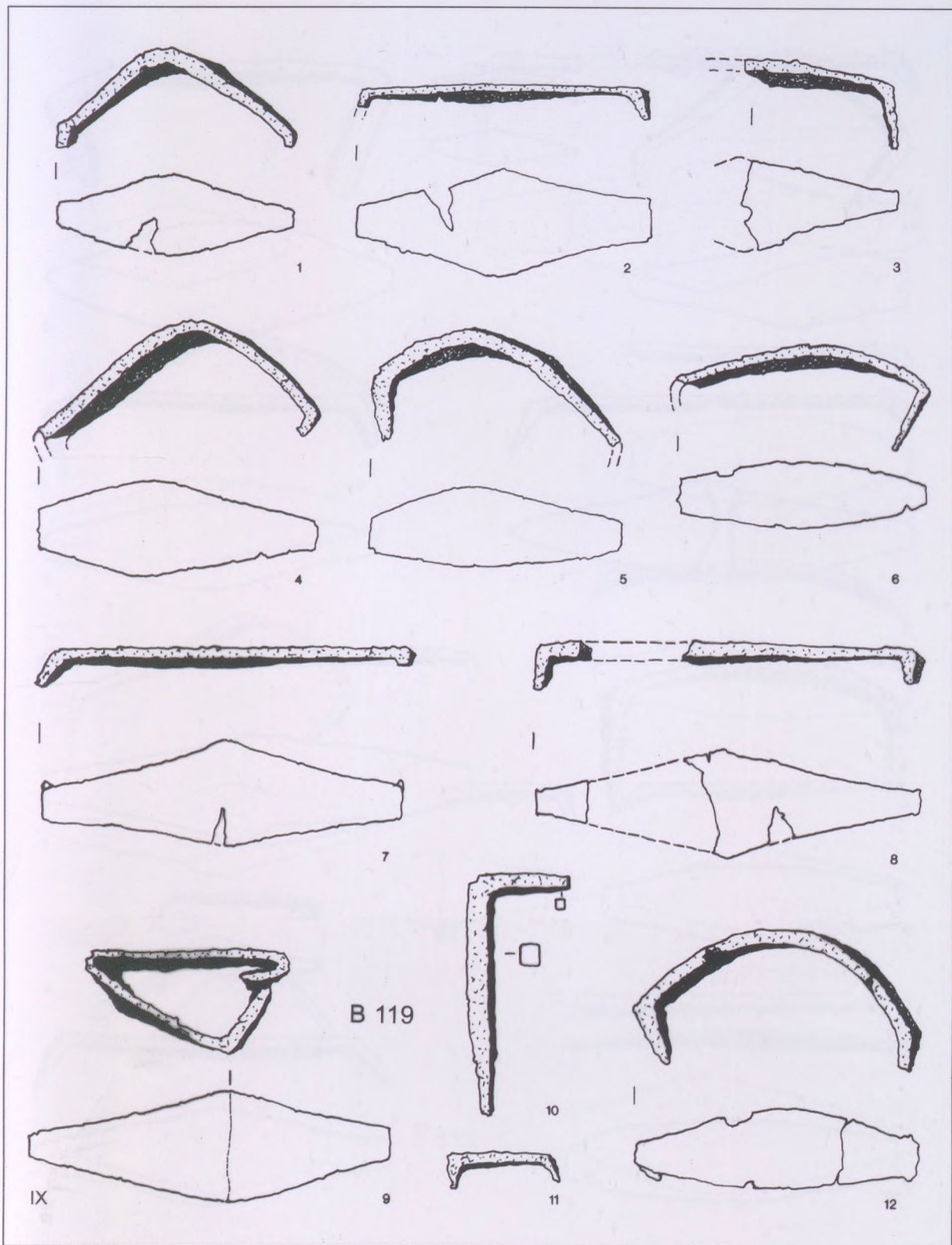

Taf. 37 Grab 119

KÖLKED – FEKETE KAPU B

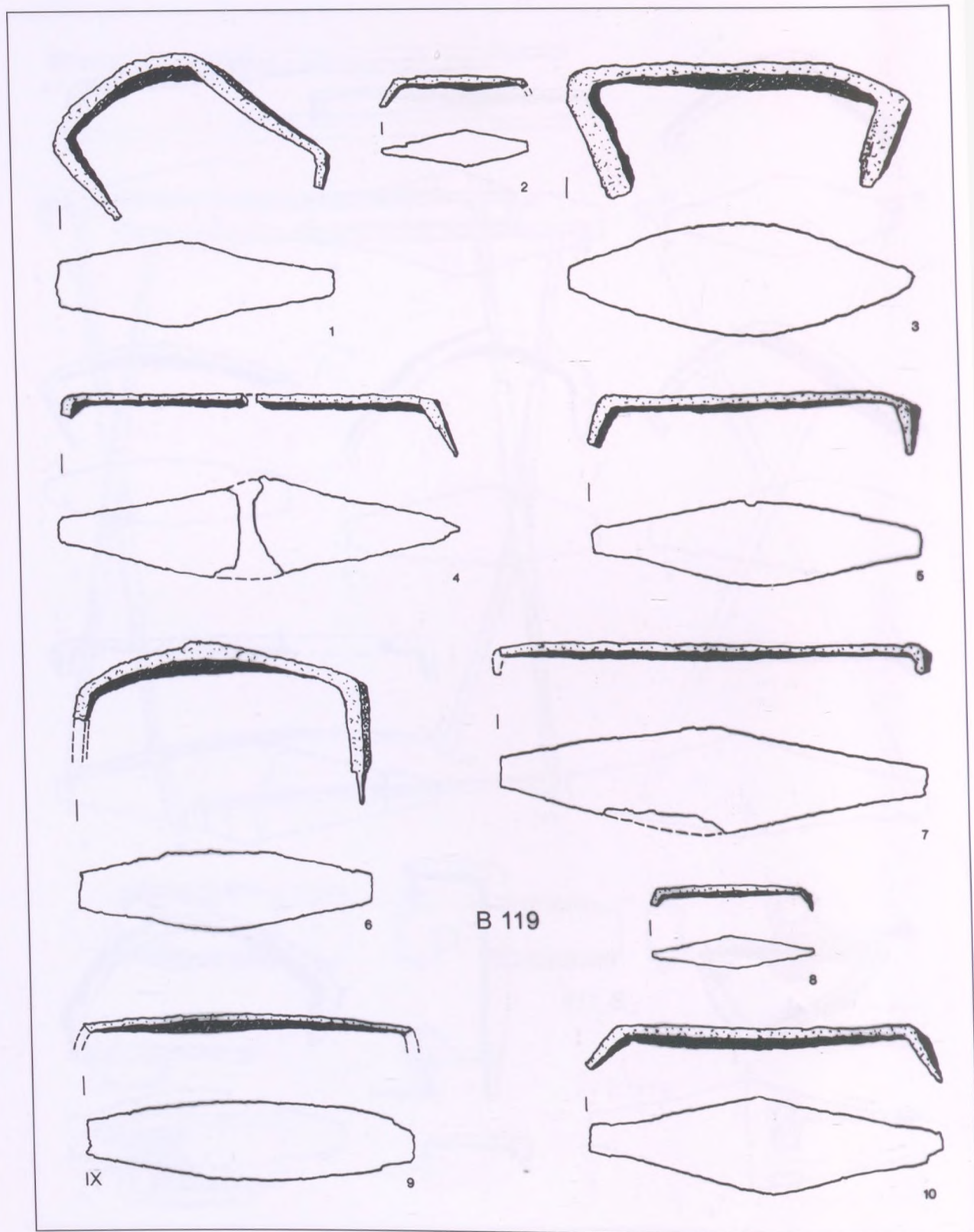

Taf. 38 Grab 119

KÖLKED – FEKETEKAPU B

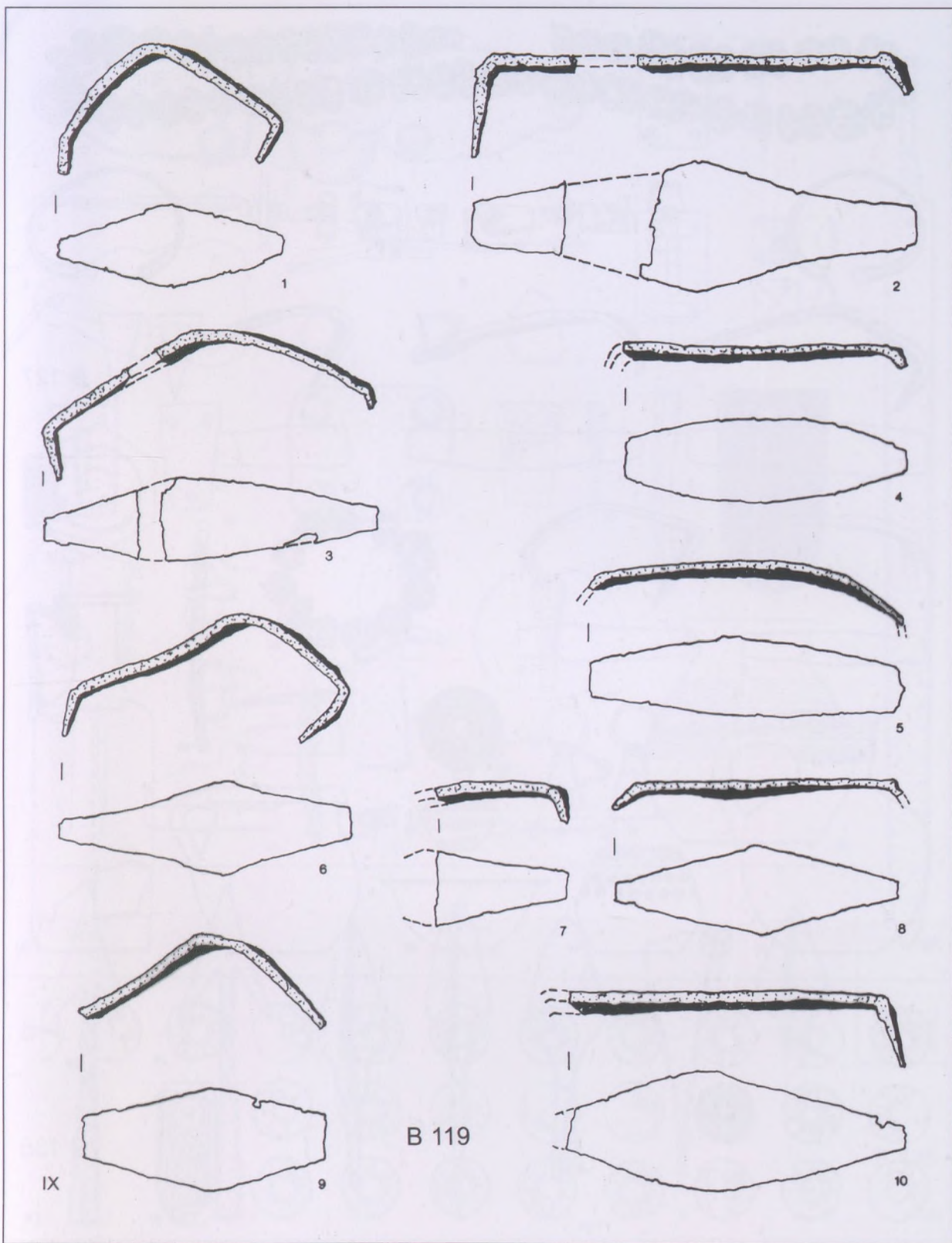

Taf. 39 Grab 119

KÖLKED – FEKETE KAPU B

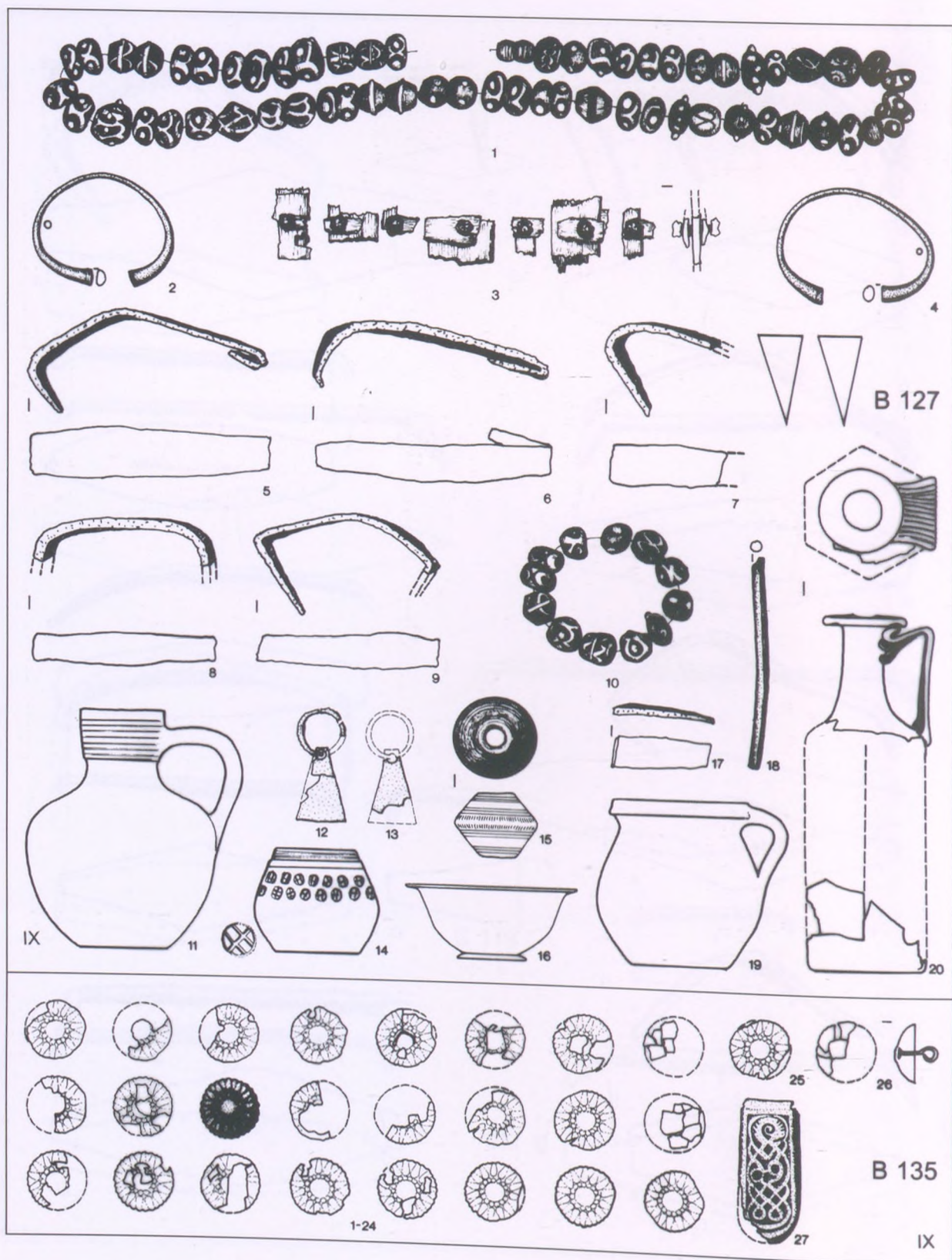

Taf. 40 Gräber 127, 135

KÖLKED – FEKETEKAJU B

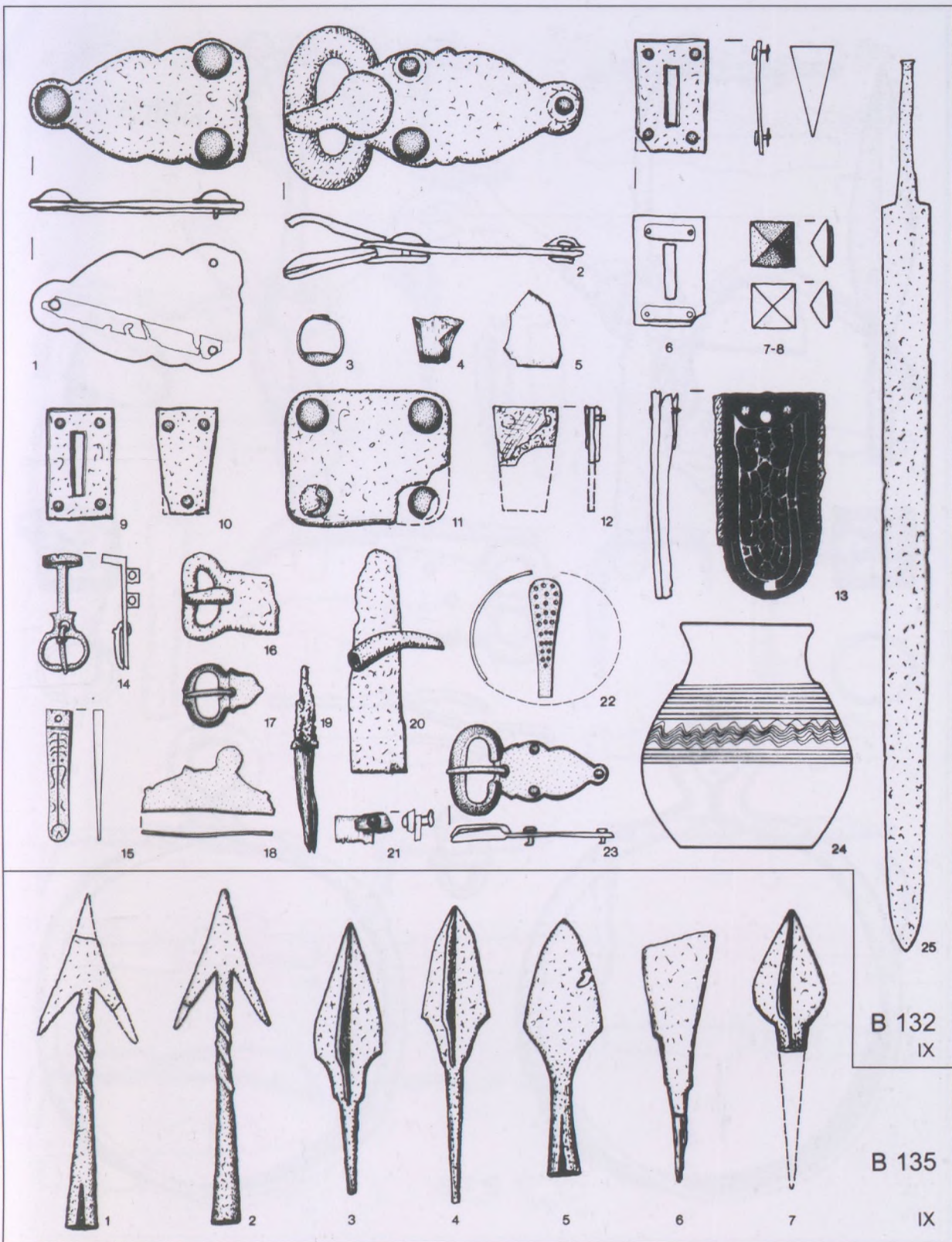

Taf. 41 Gräber 132, 135

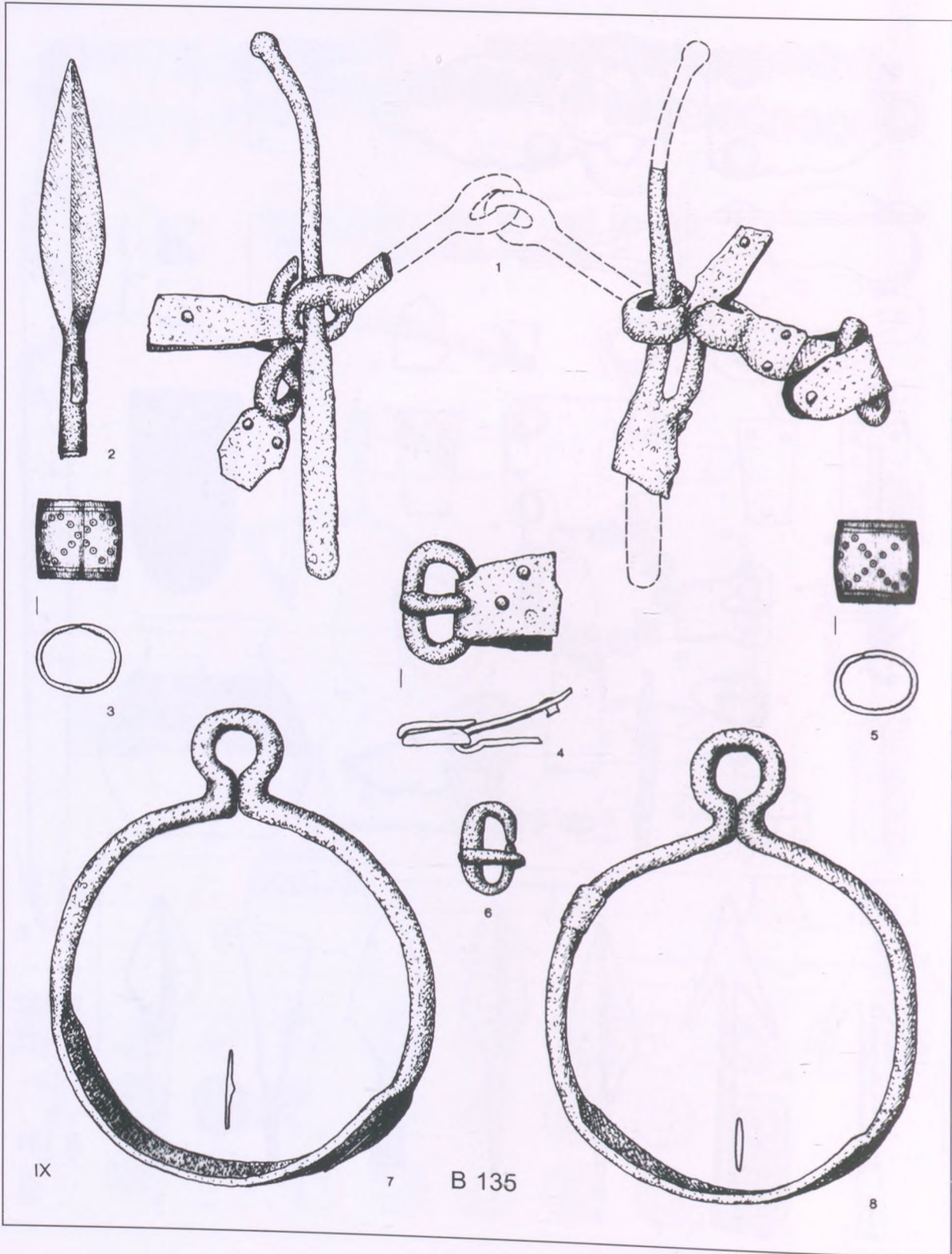

Taf. 42 Grab 135

KÖLKED – FEKETEKAJU B

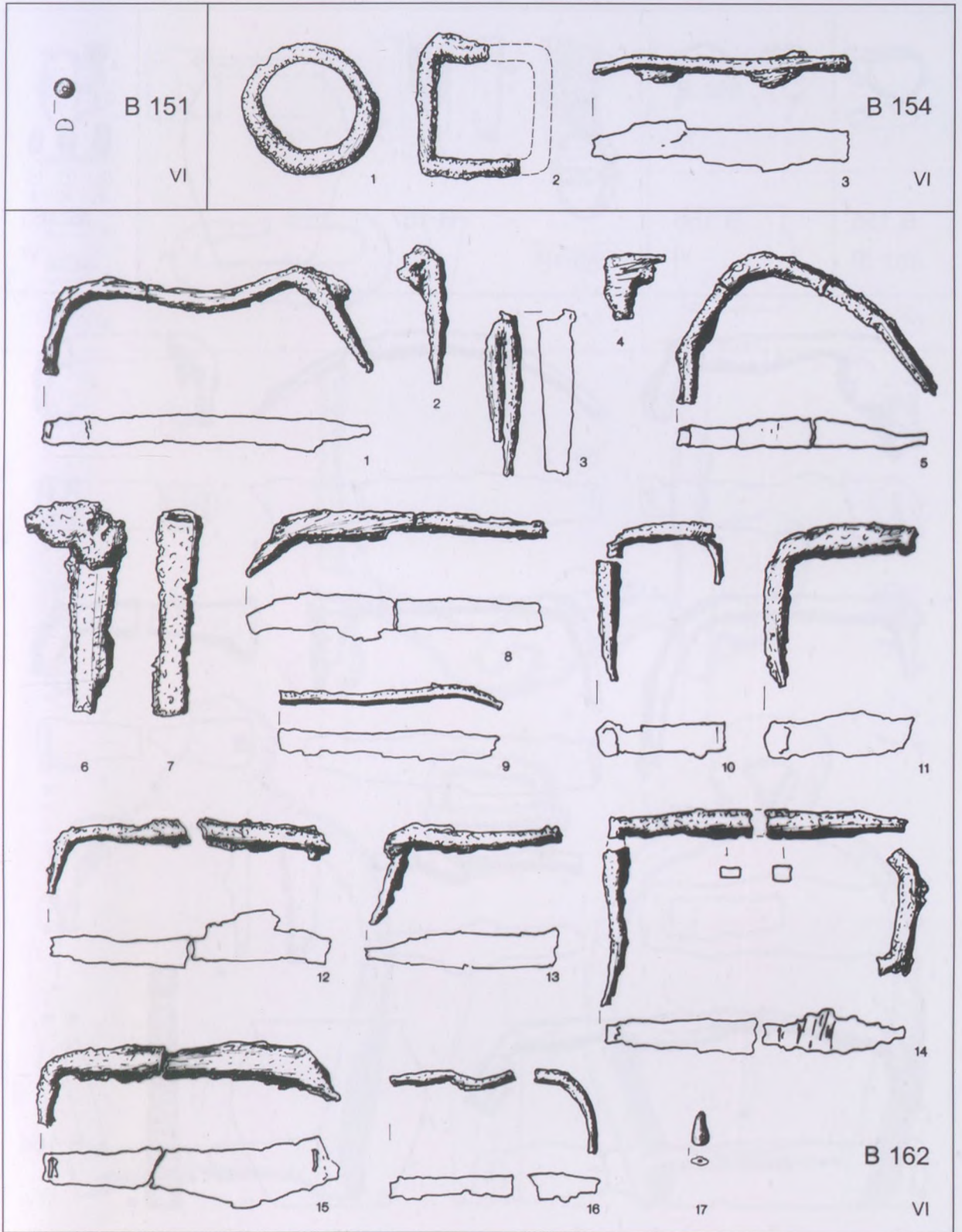

Taf. 43 Gräber 151, 154, 162

KÖLKED – FEKETEKAPOU B

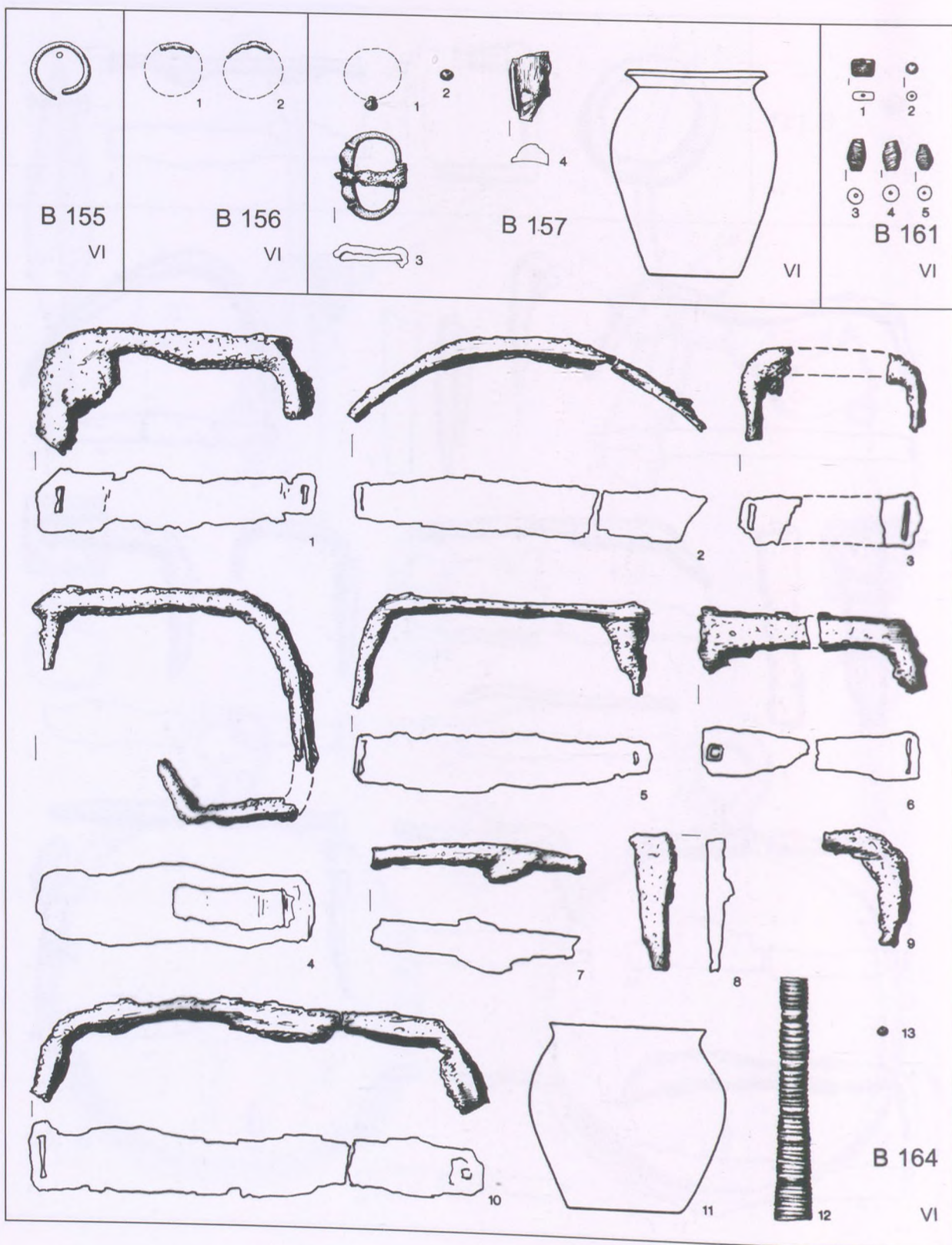

Taf. 44 Gräber 155, 156, 157, 161, 164

KÖLKED – FEKETEKAPO B

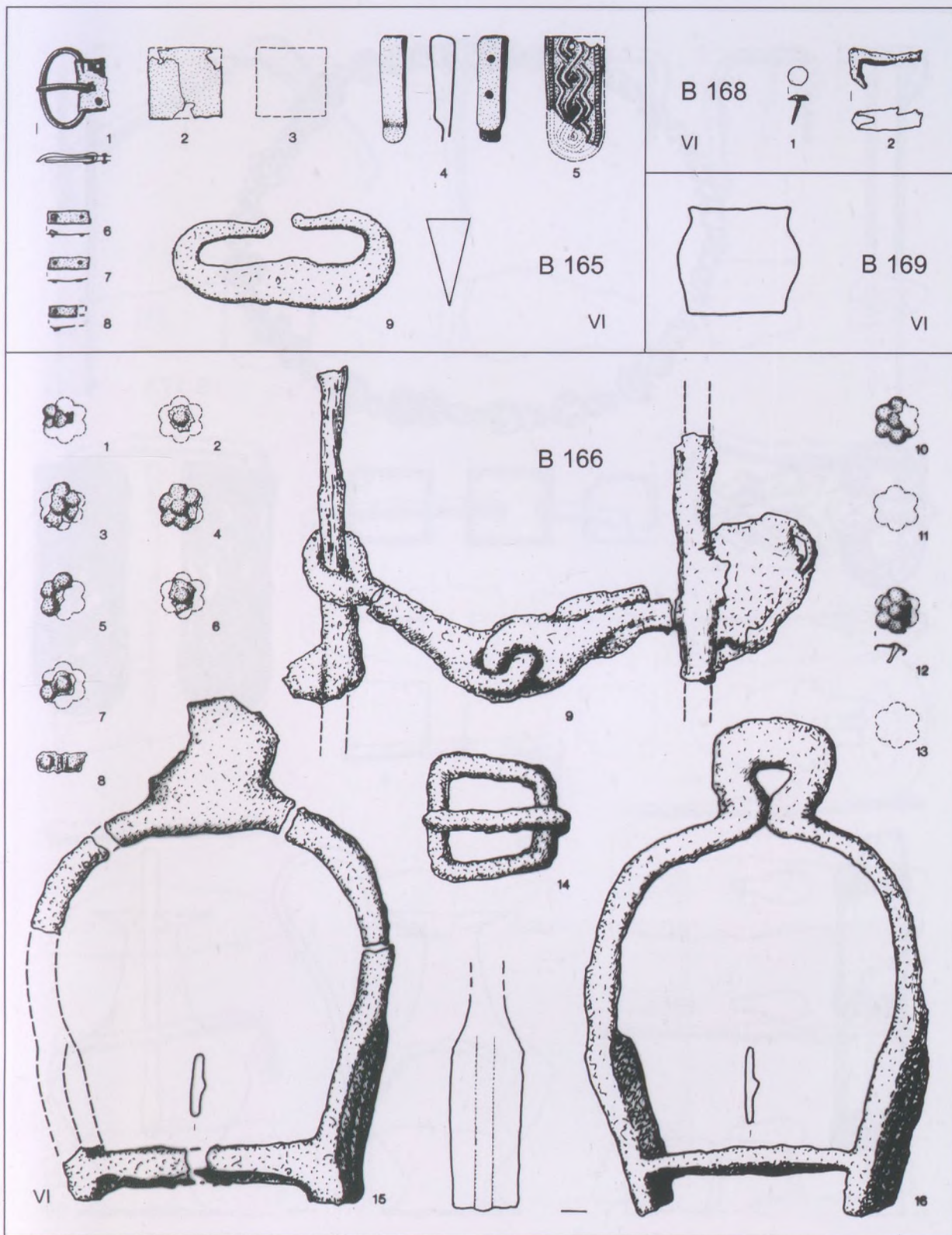

Taf. 45 Gräber 165, 166, 168, 169

KÖLKED – FEKETEKAJU B

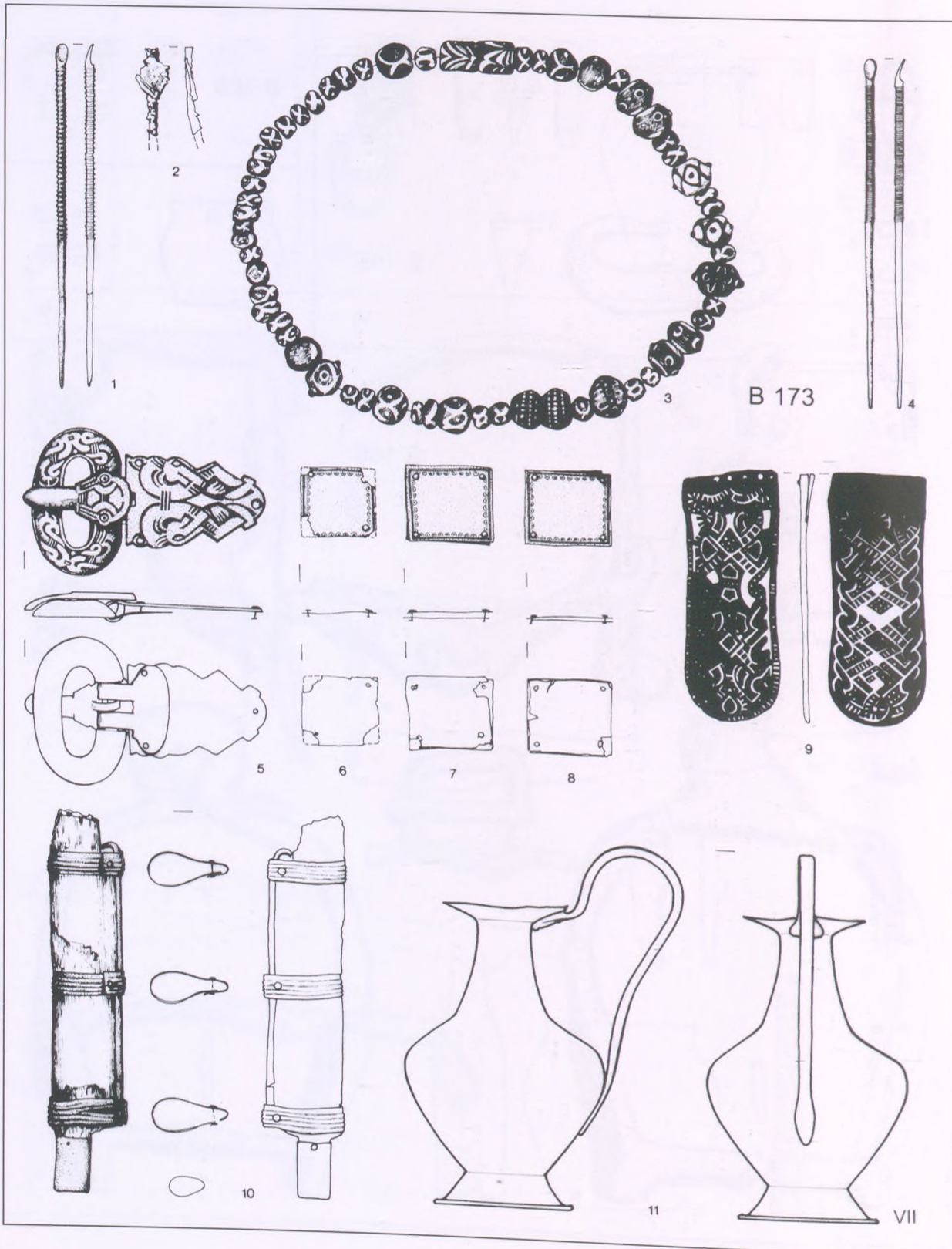

Taf. 46 Grab 173

KÖLKED – FEKETEKAJU B

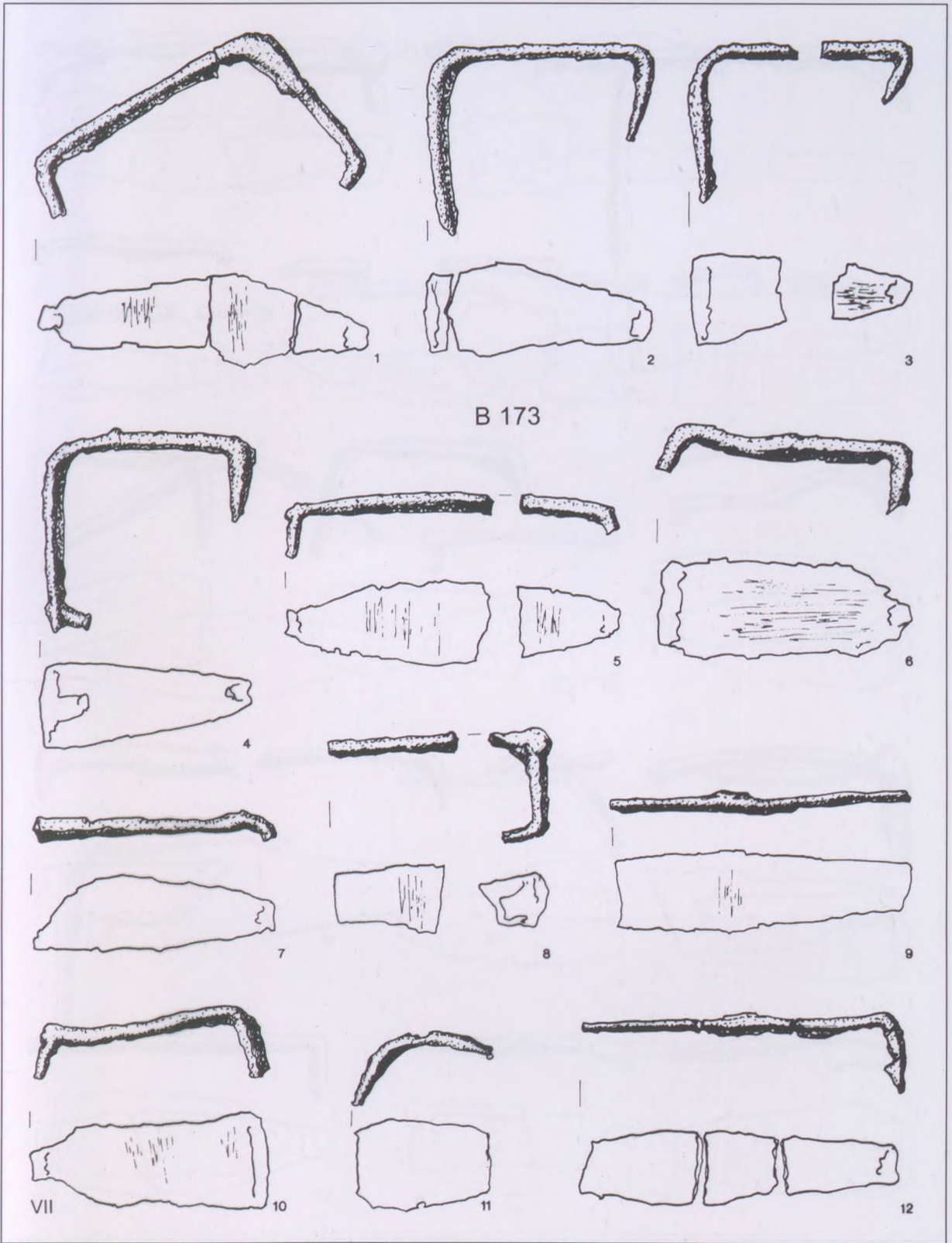

Taf. 47 Grab 173

KÖLKED - FEKETE KAPU B

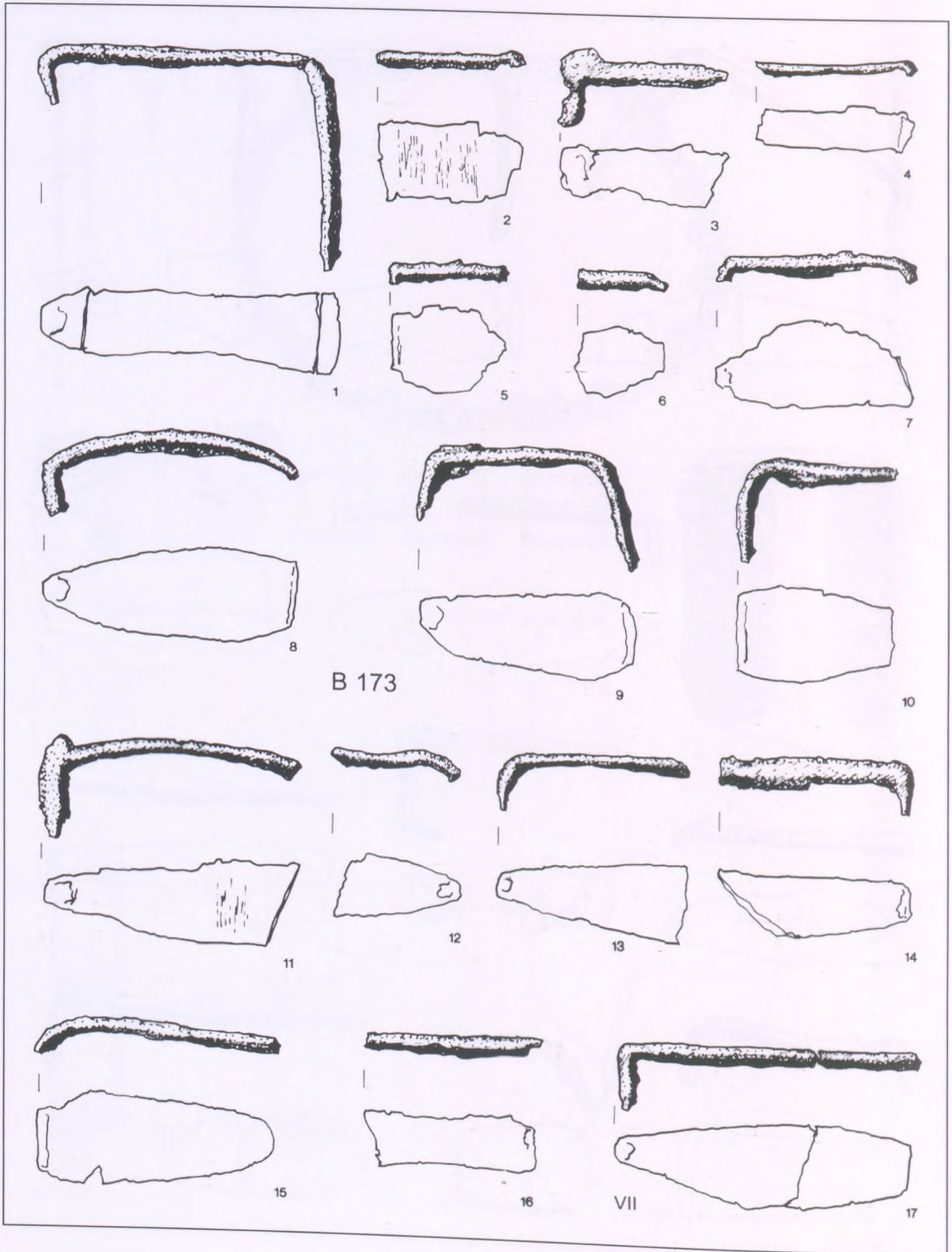

Taf. 48 Grab 173

KÖLKED – FEKETE KAPU B

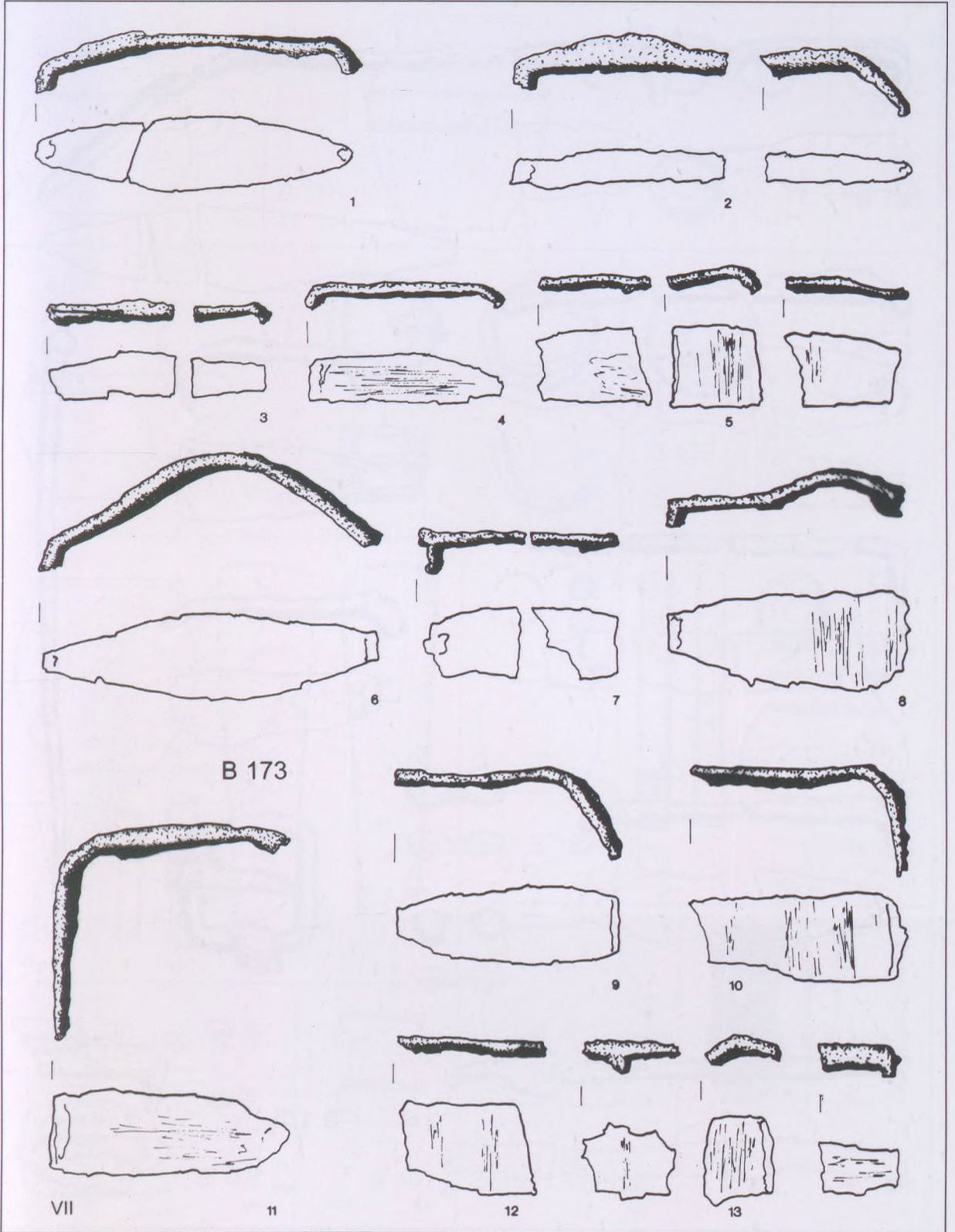

Taf. 49 Grab 173

KÖLKED - FEKETEKAJU B

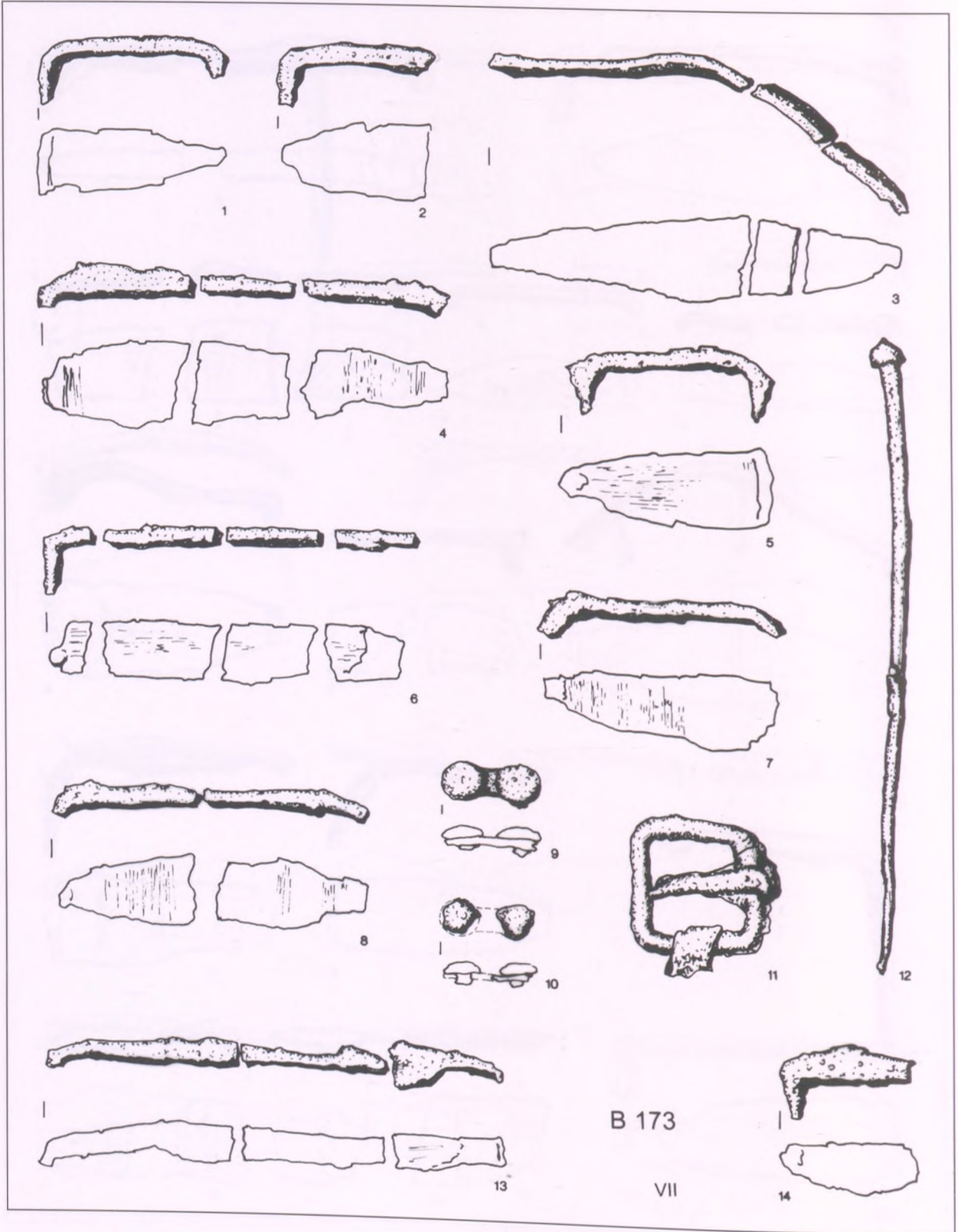

B 173

VII

Taf. 50 Grab 173

KÖLKED – FEKETEKAU B

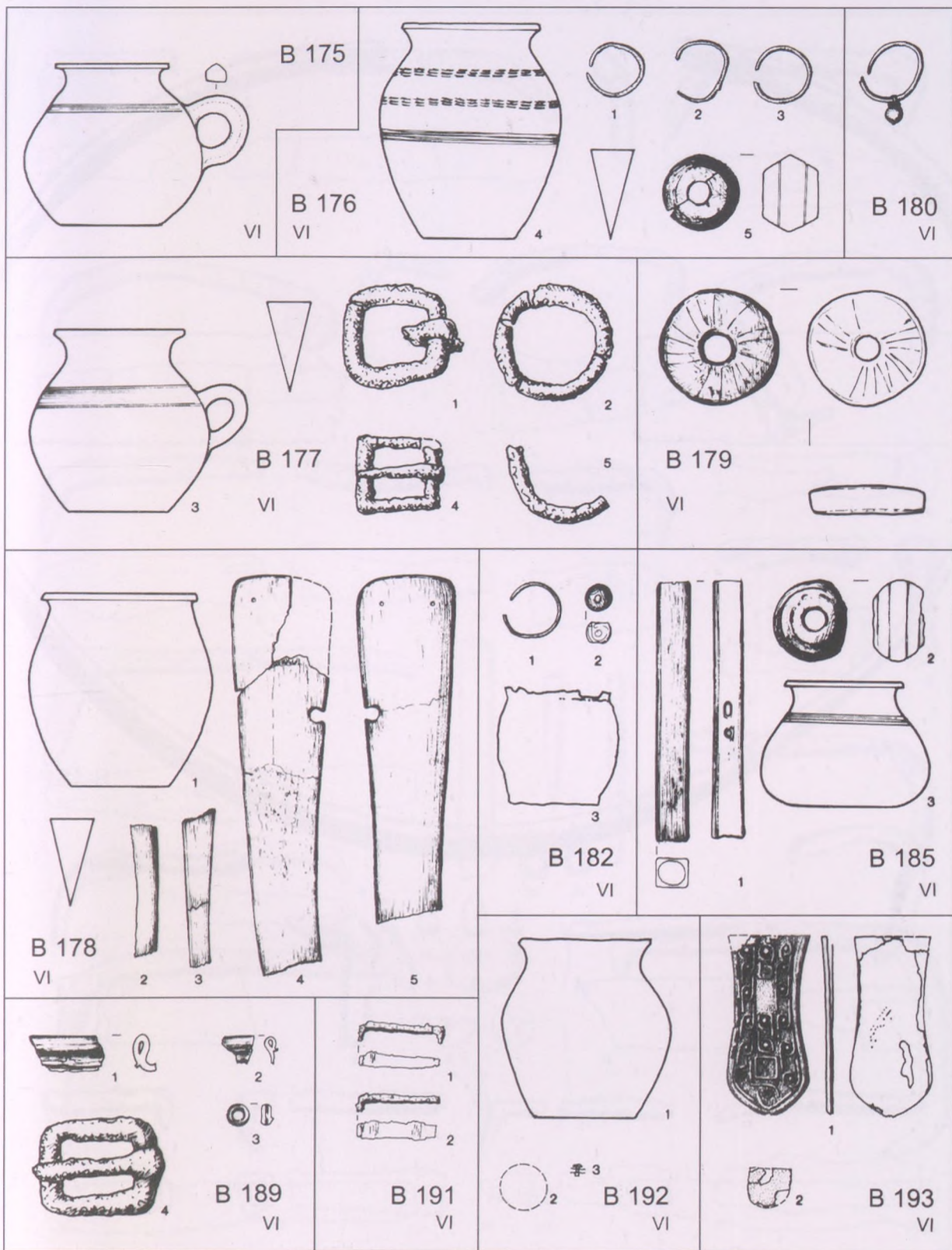

Taf. 51 Gräber 175, 176, 177, 178, 179, 180, 182, 185, 189, 191, 192, 193

KÖLKED - FEKETEKAPO B

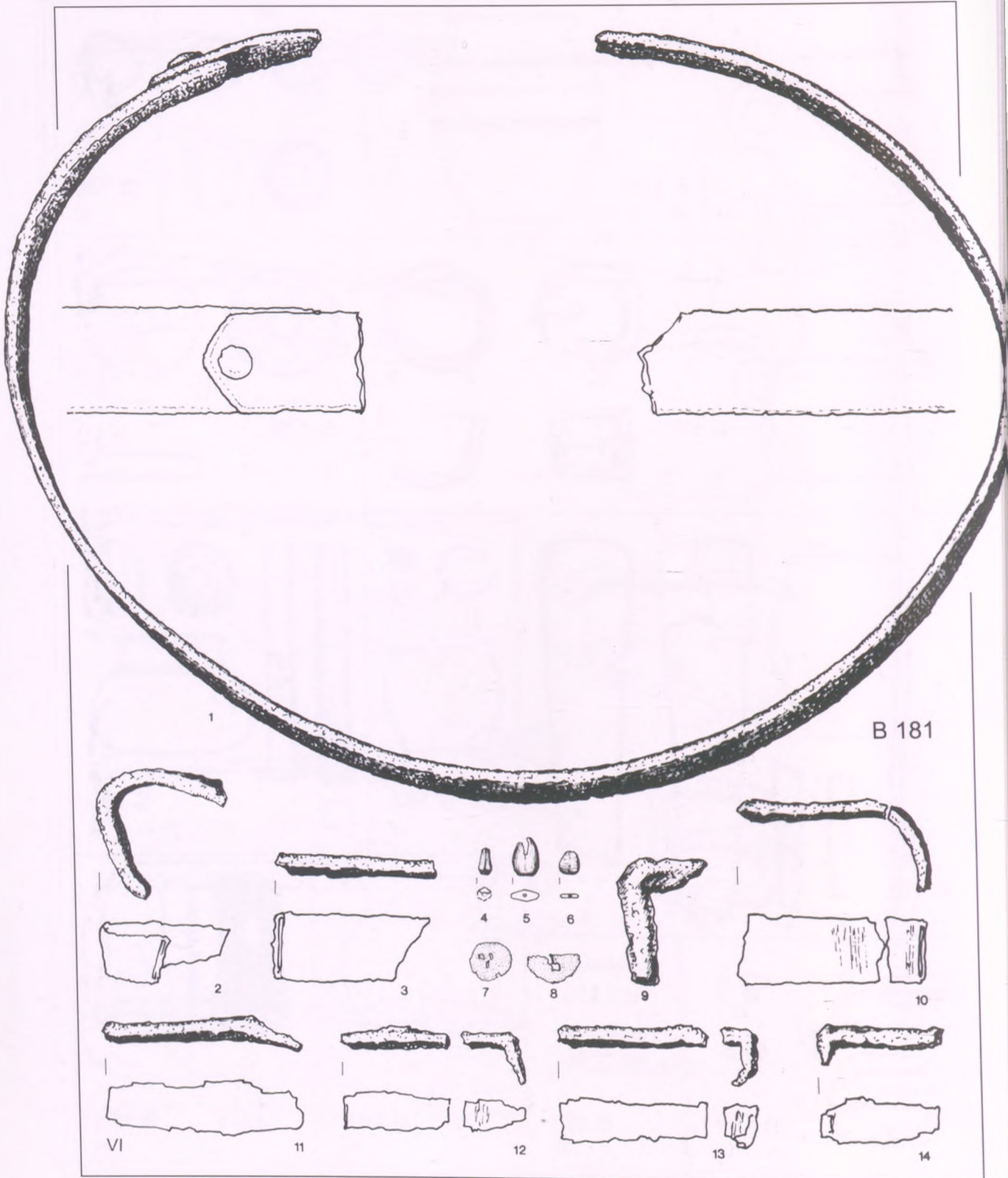

Taf. 52 Grab 181

KÖLKED - FEKETE KAPU B

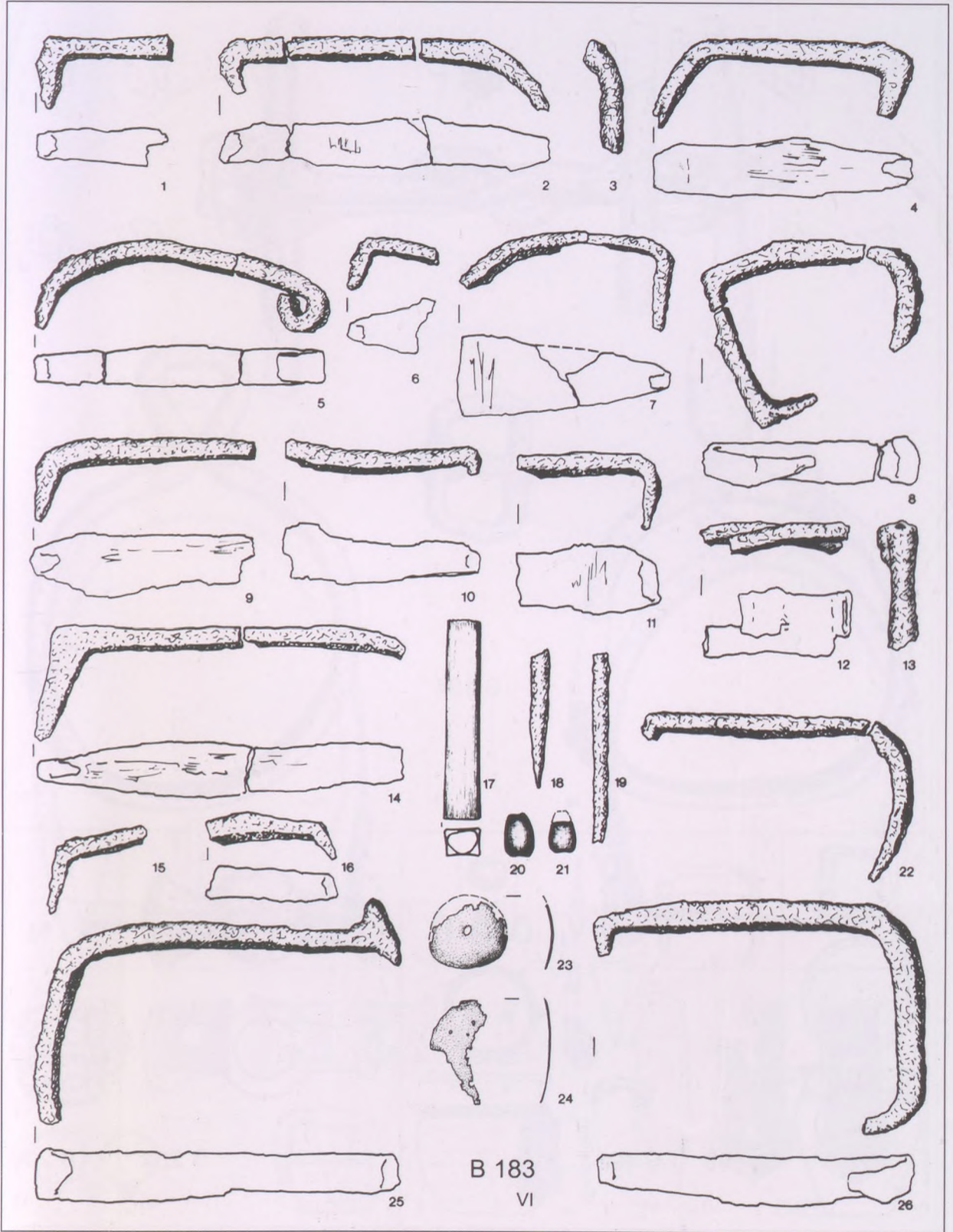

Taf. 53 Grab 183

KÖLKED - FEKETEKAJU B

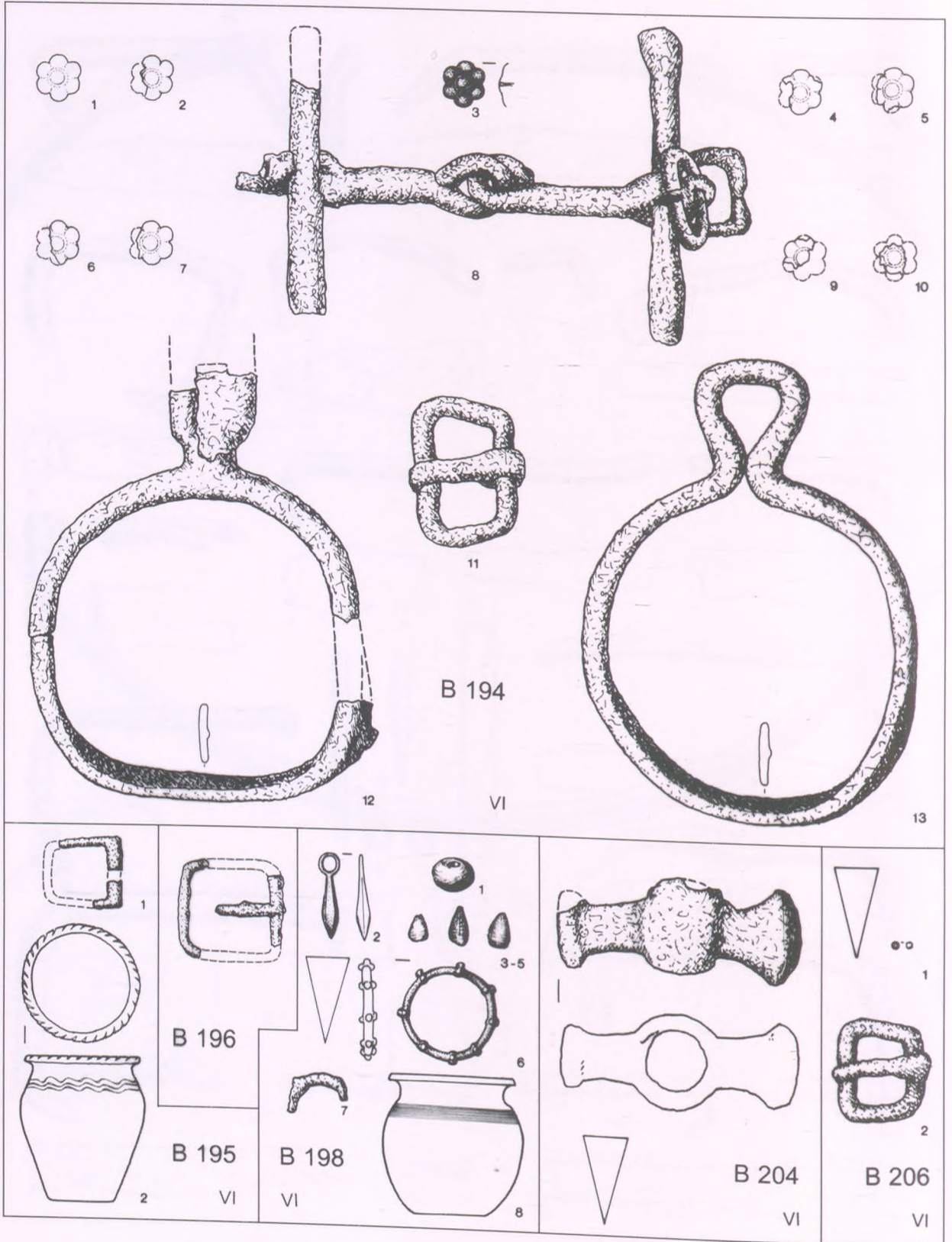

Taf. 54 Gräber 194, 195, 196, 198, 204, 206

KÖLKED - FEKETEKAJU B

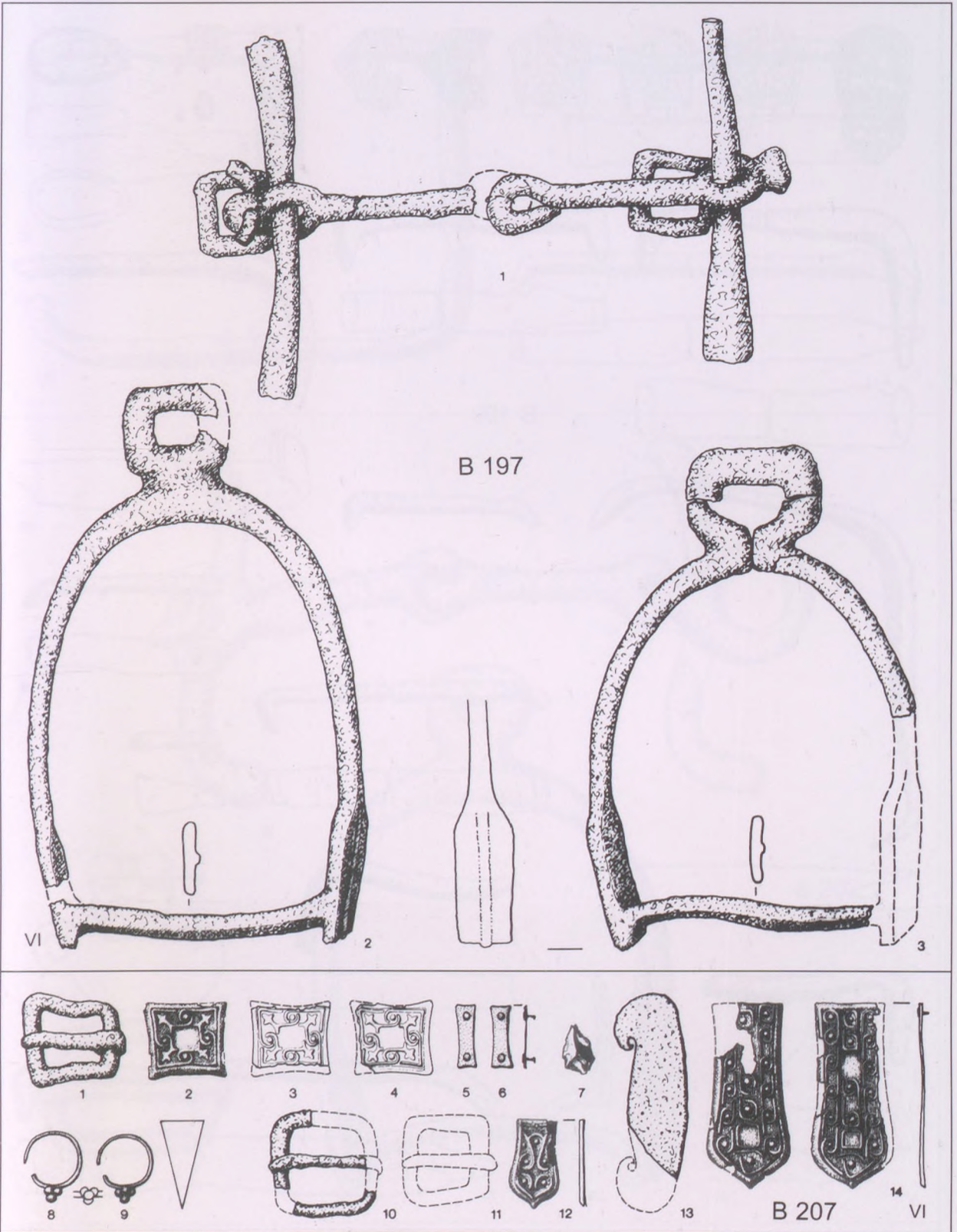

Taf. 55 Gräber 197, 207

KÖLKED – FEKETEKAPOU B

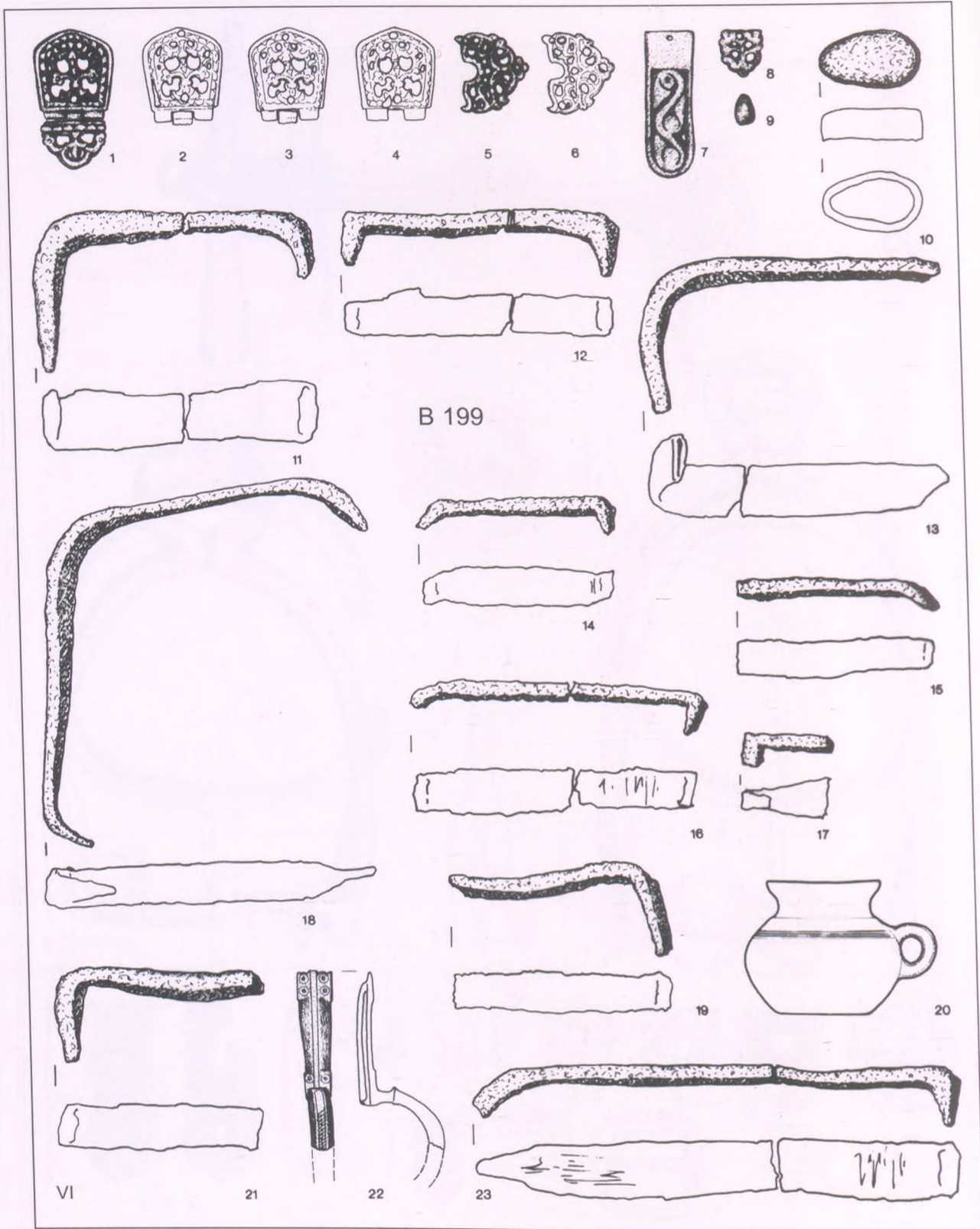

Taf. 56 Grab 199

KÖLKED – FEKETEKAPO B

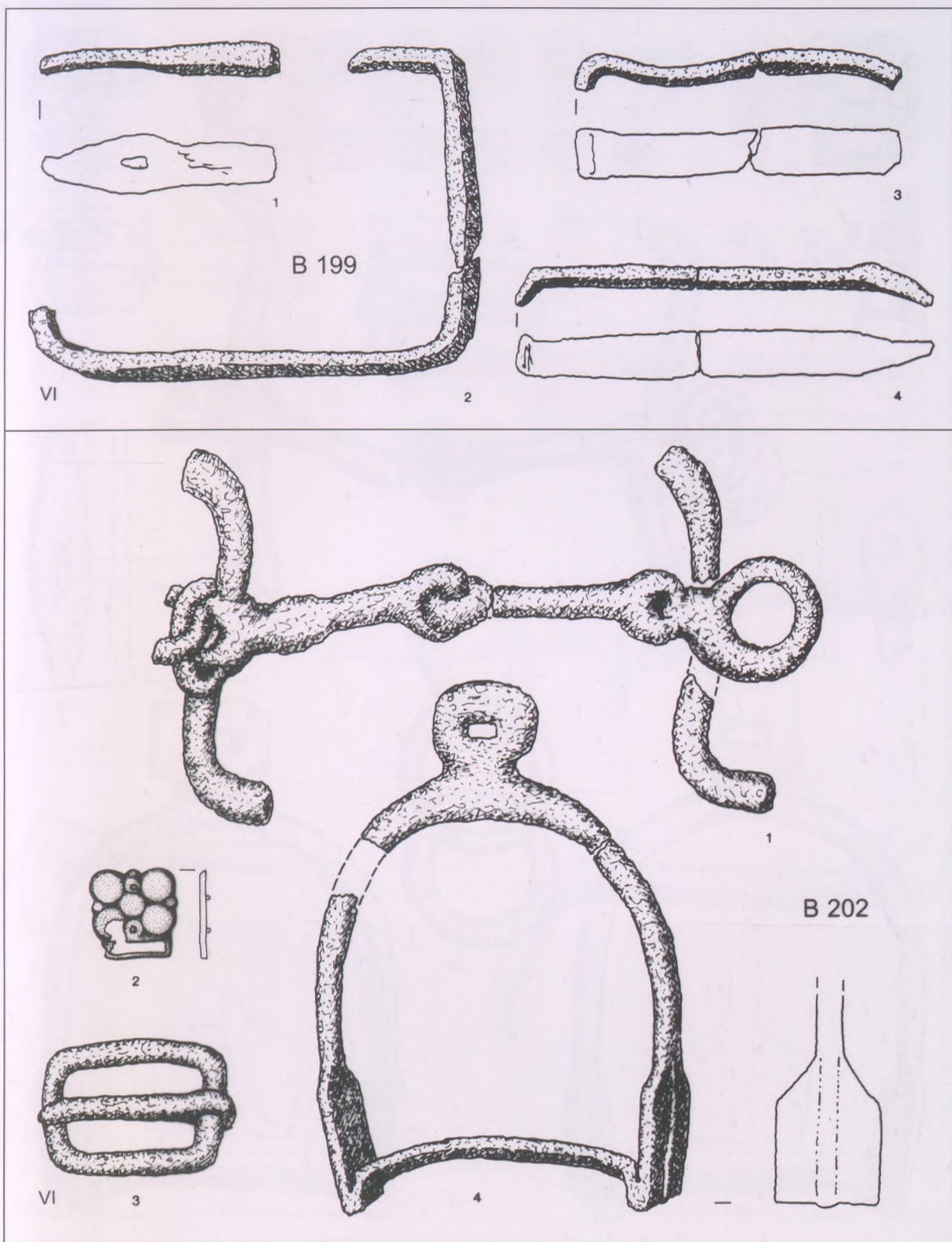

Taf. 57 Gräber 199, 202

KÖLKED – FEKETEKAPU B

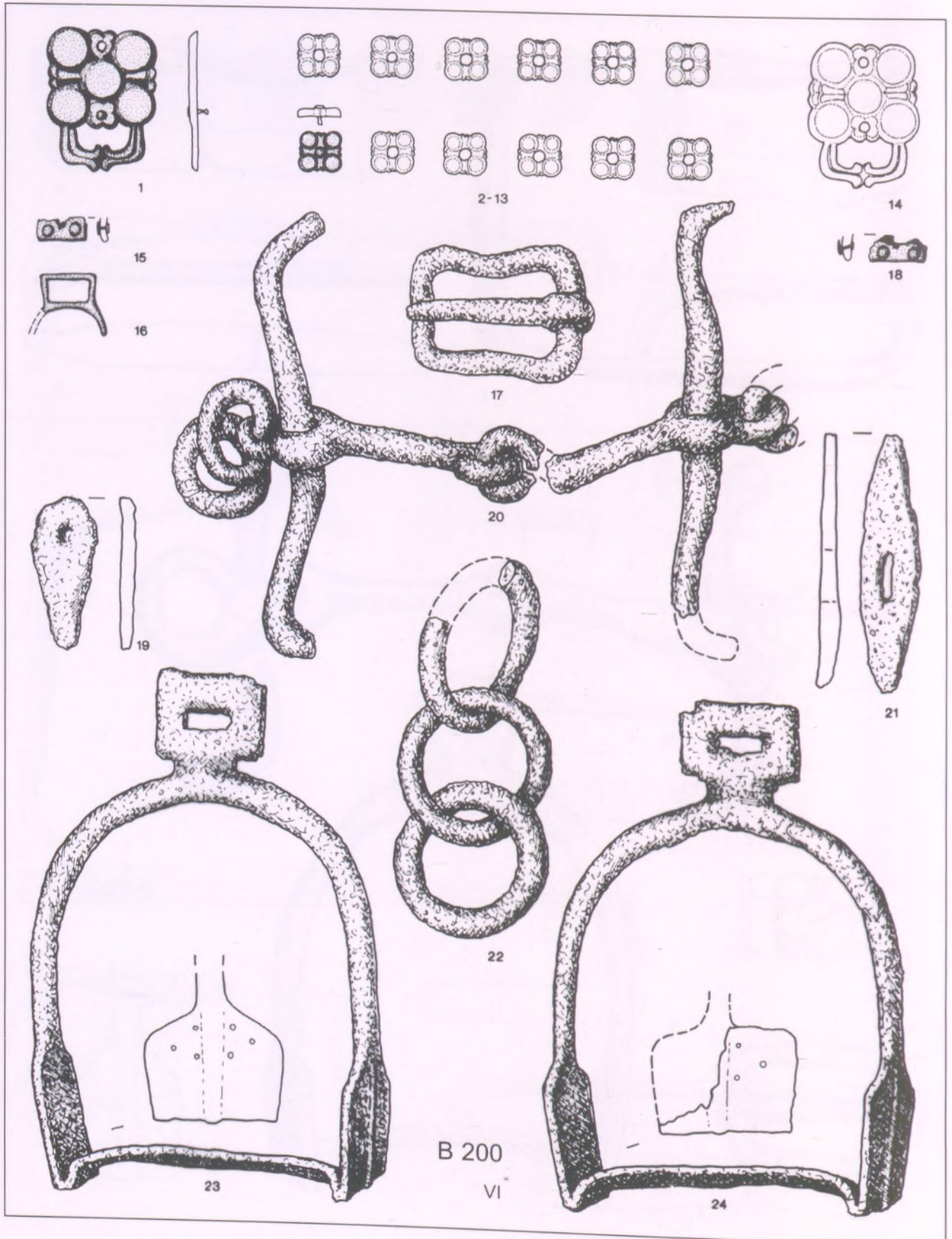

Taf. 58 Grab 200

KÖLKED – FEKETE KAPU B

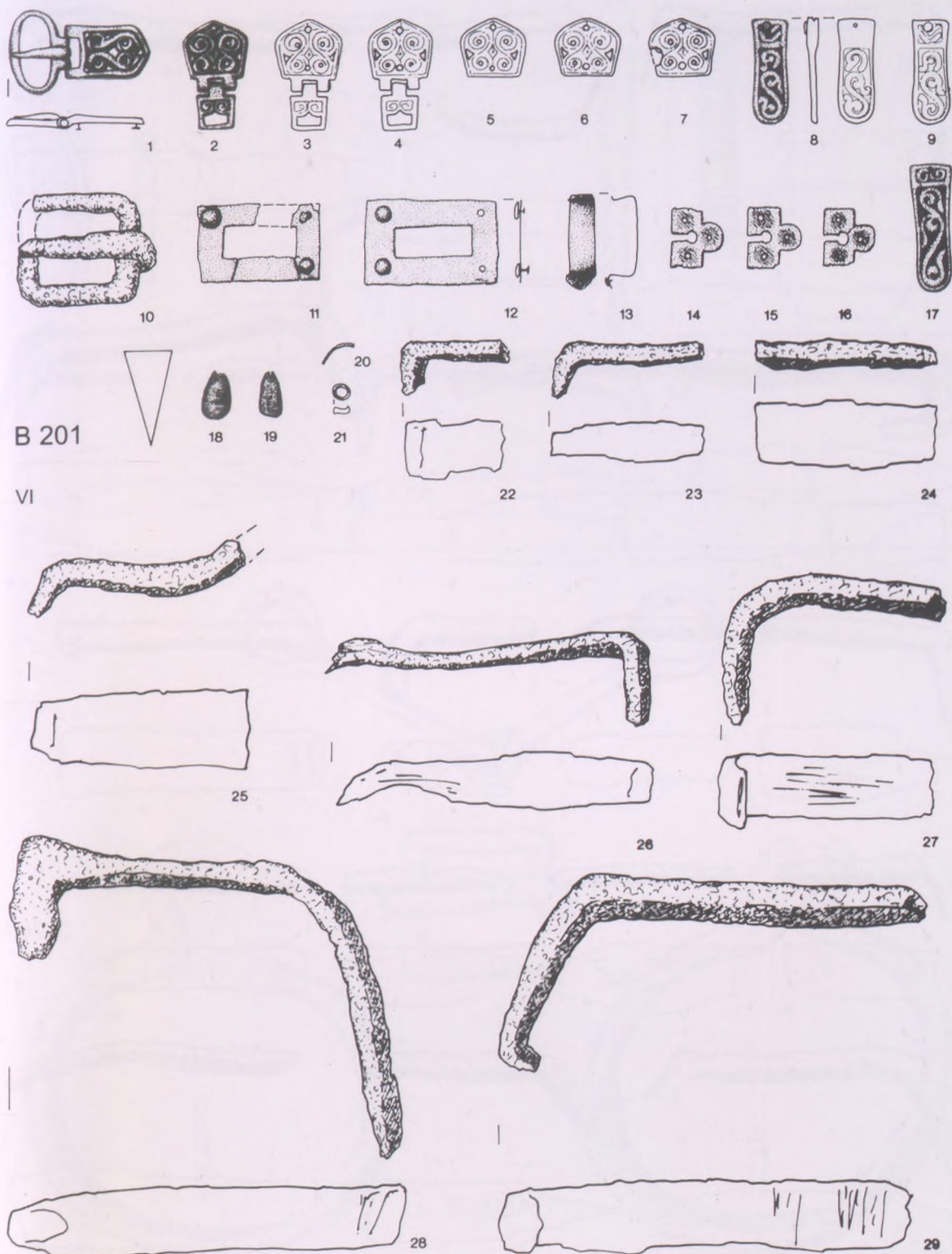

Taf. 59 Grab 201

KÖLKED - FEKETEKAPO B

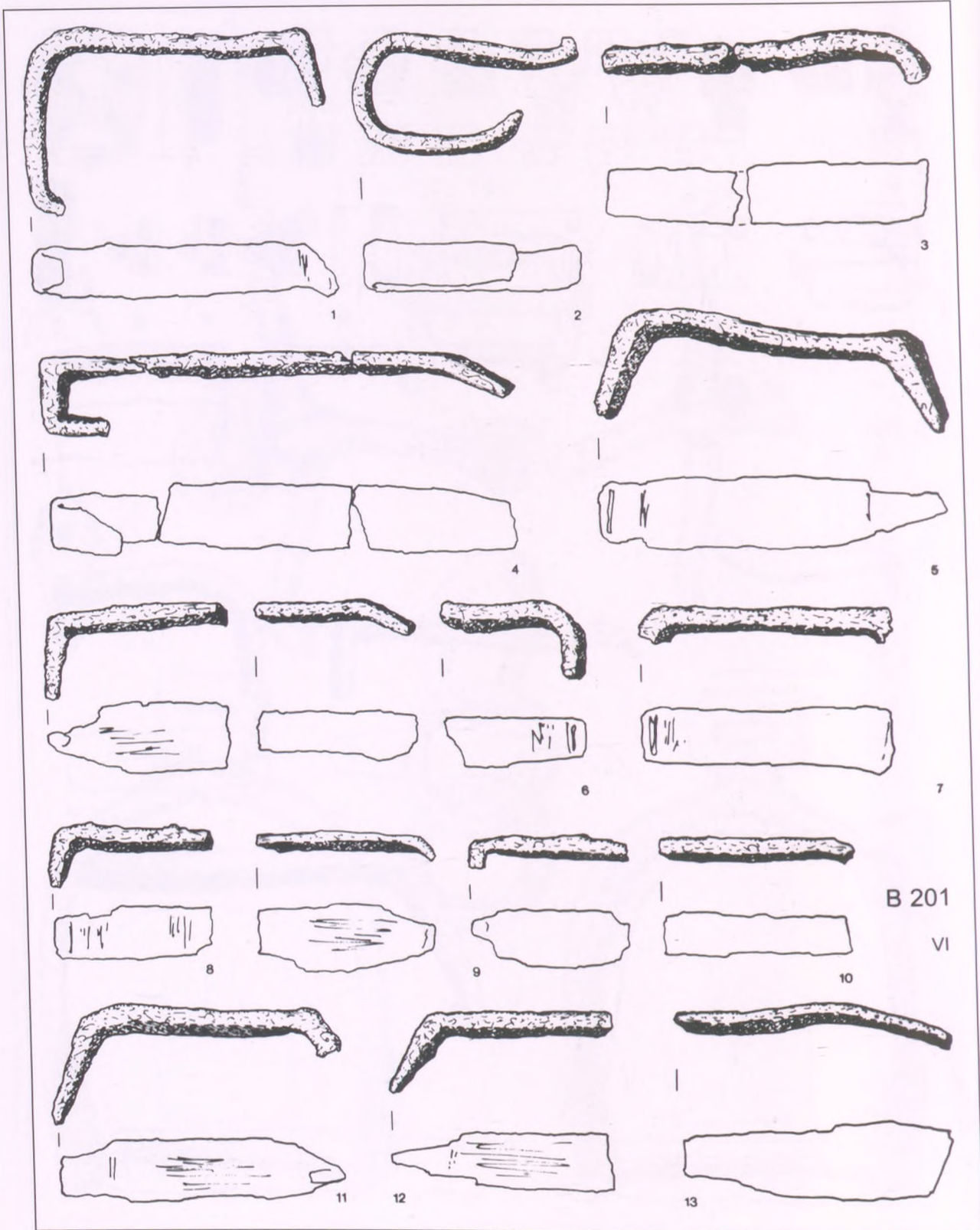

Taf. 60 Grab 201

KÖLKED - FEKETEKAPO B

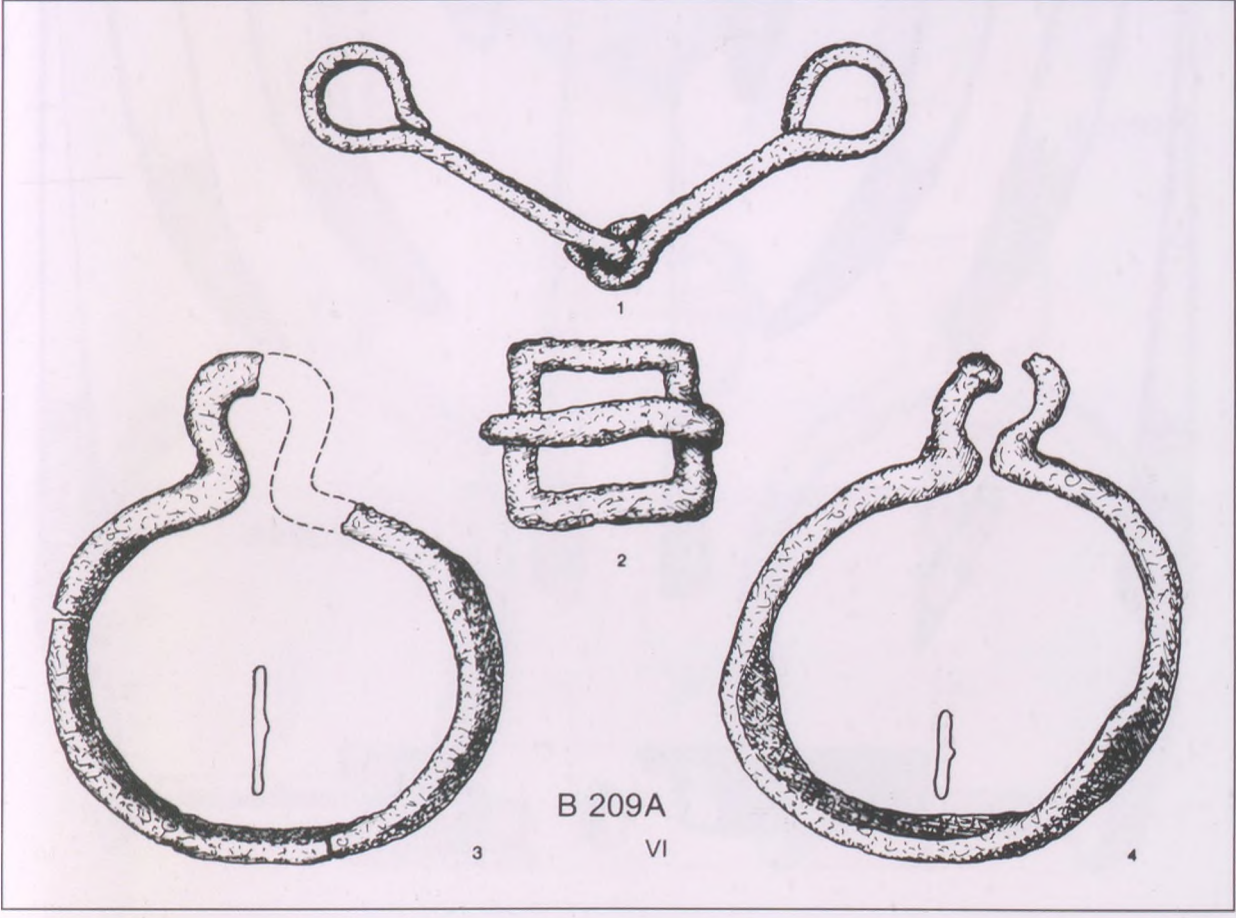
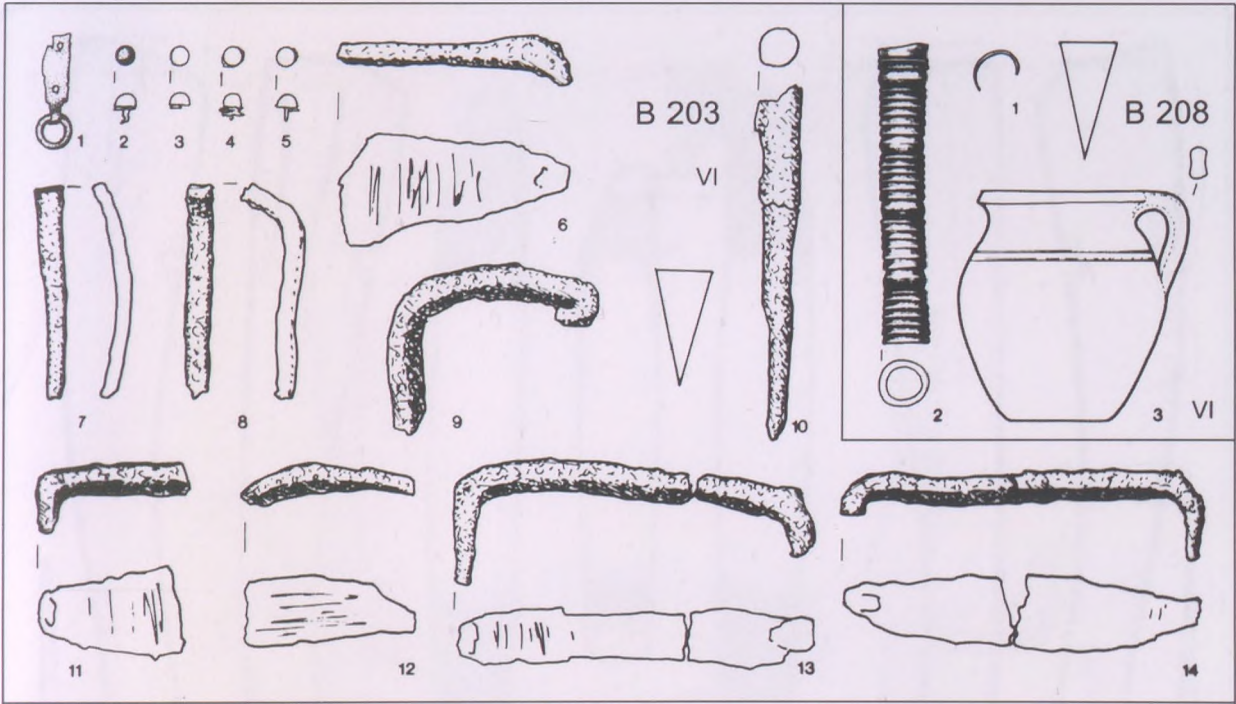

Taf. 61 Gräber 203, 208, 209A

KÖLKED – FEKETEKAPOU B

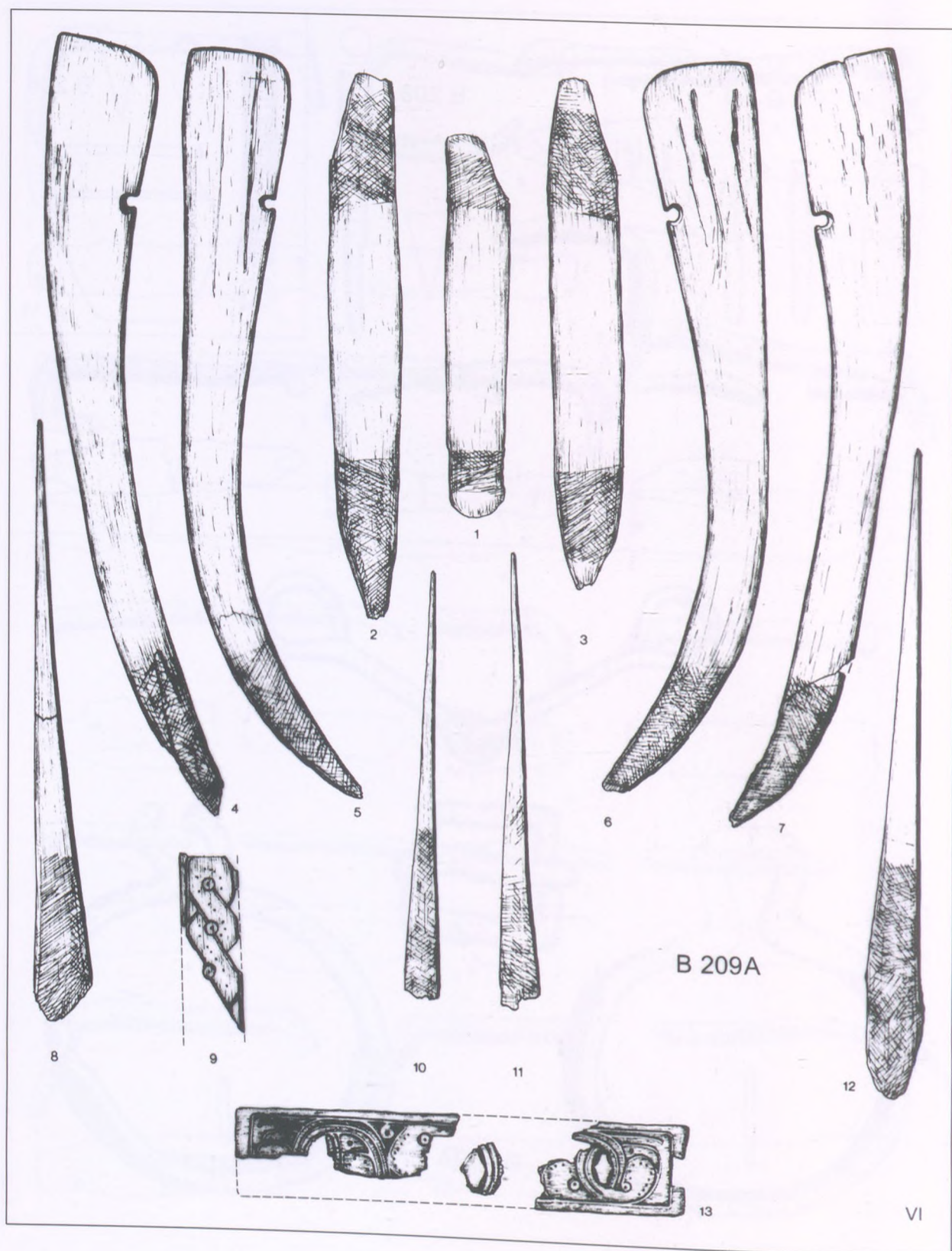

Taf. 62 Grab 209A

KÖLKED – FEKETE KAPU B

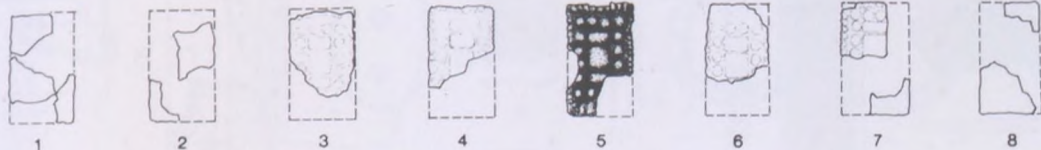

B 209A

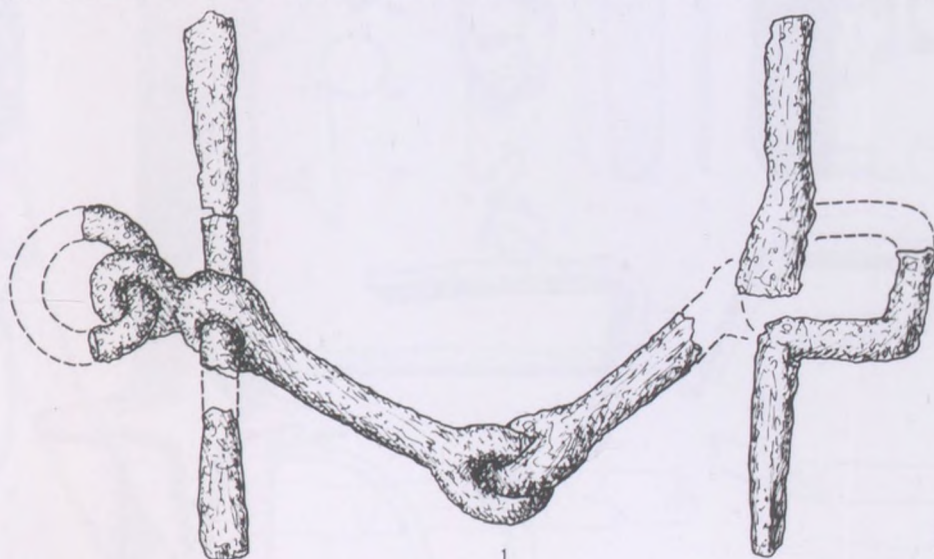

B 209B

VI

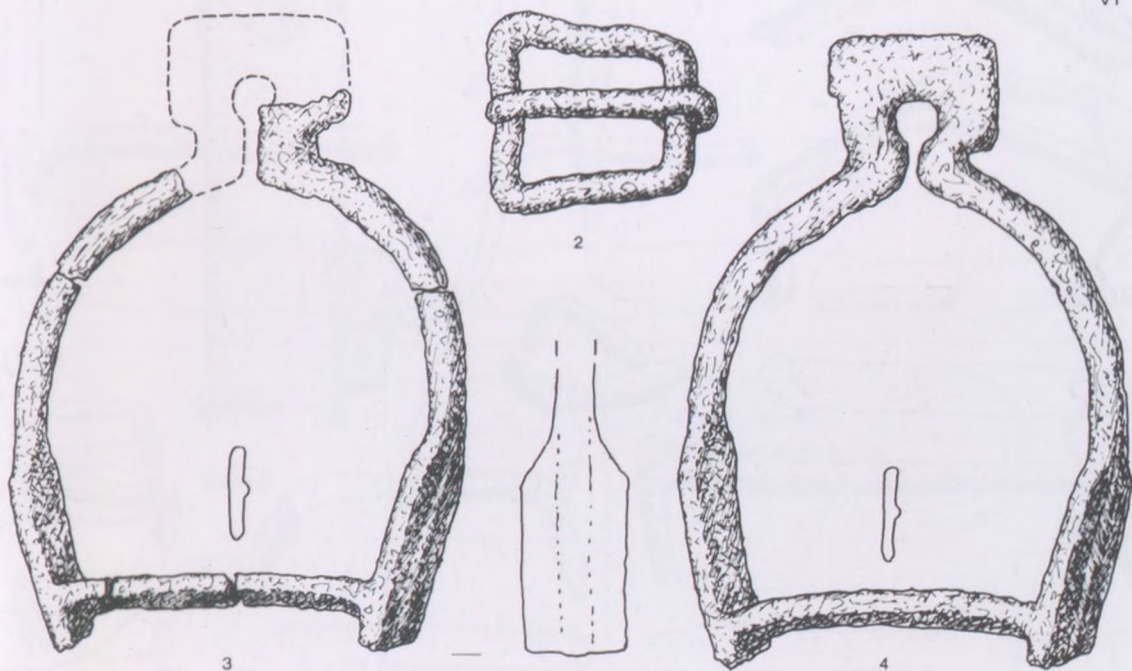

Taf. 63 Grab 209A, 209B

KÖLKED – FEKETE KAPU B

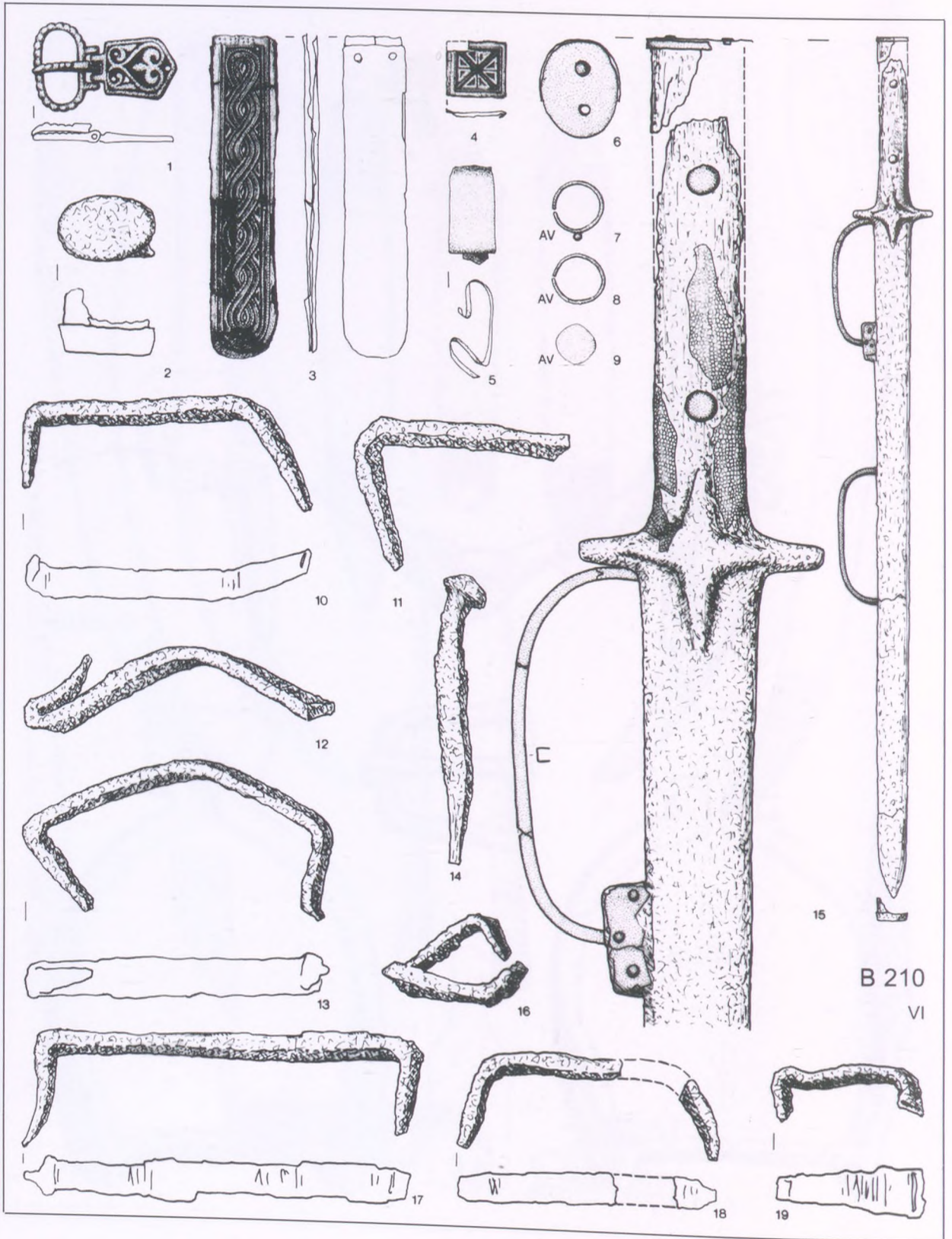

B 210
VI

Taf. 64 Grab 210

KÖLKED – FEKETEKAJU B

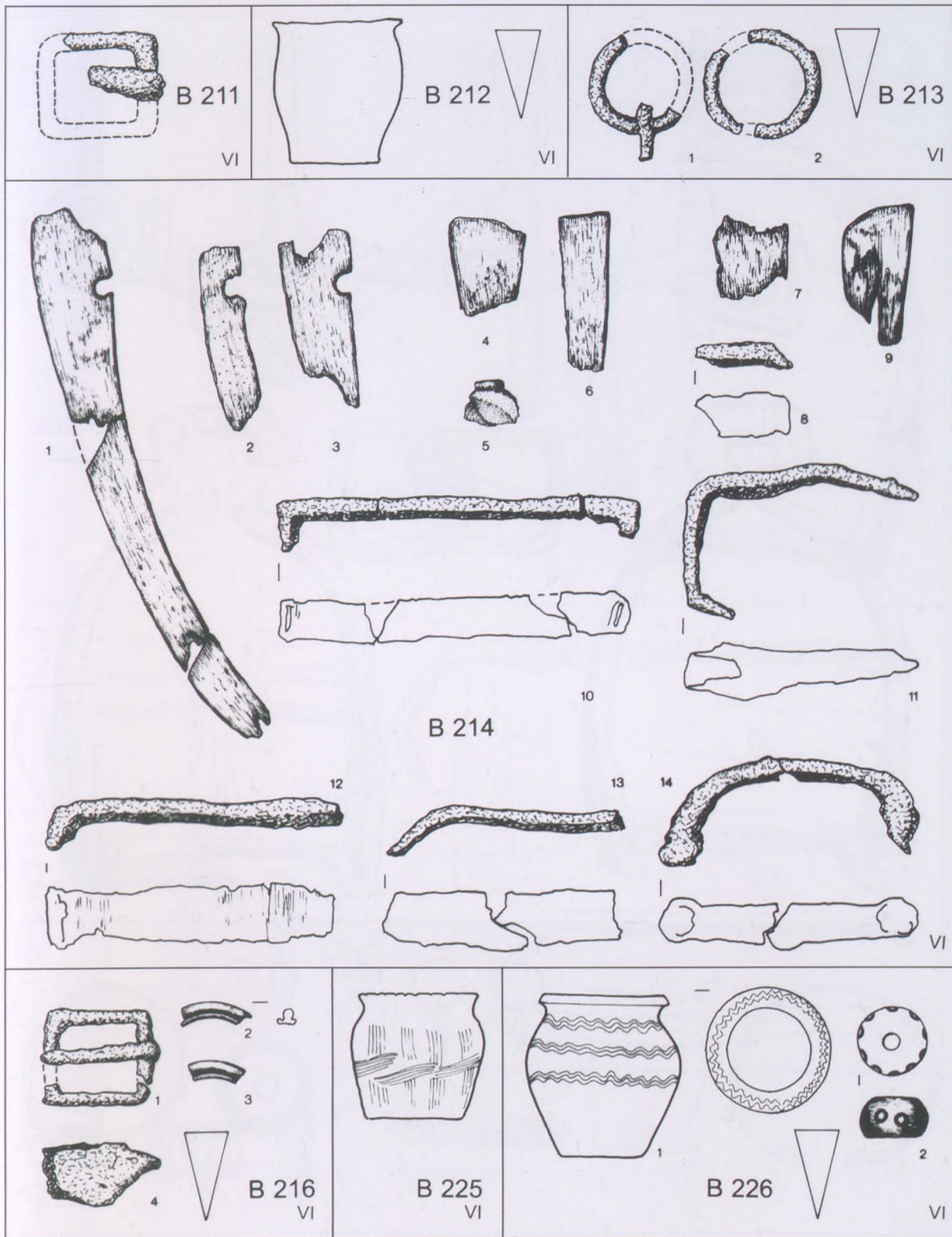

Taf. 65 Gräber 211, 212, 213, 214, 216, 225, 226

KÖLKED – FEKETEKAPO B

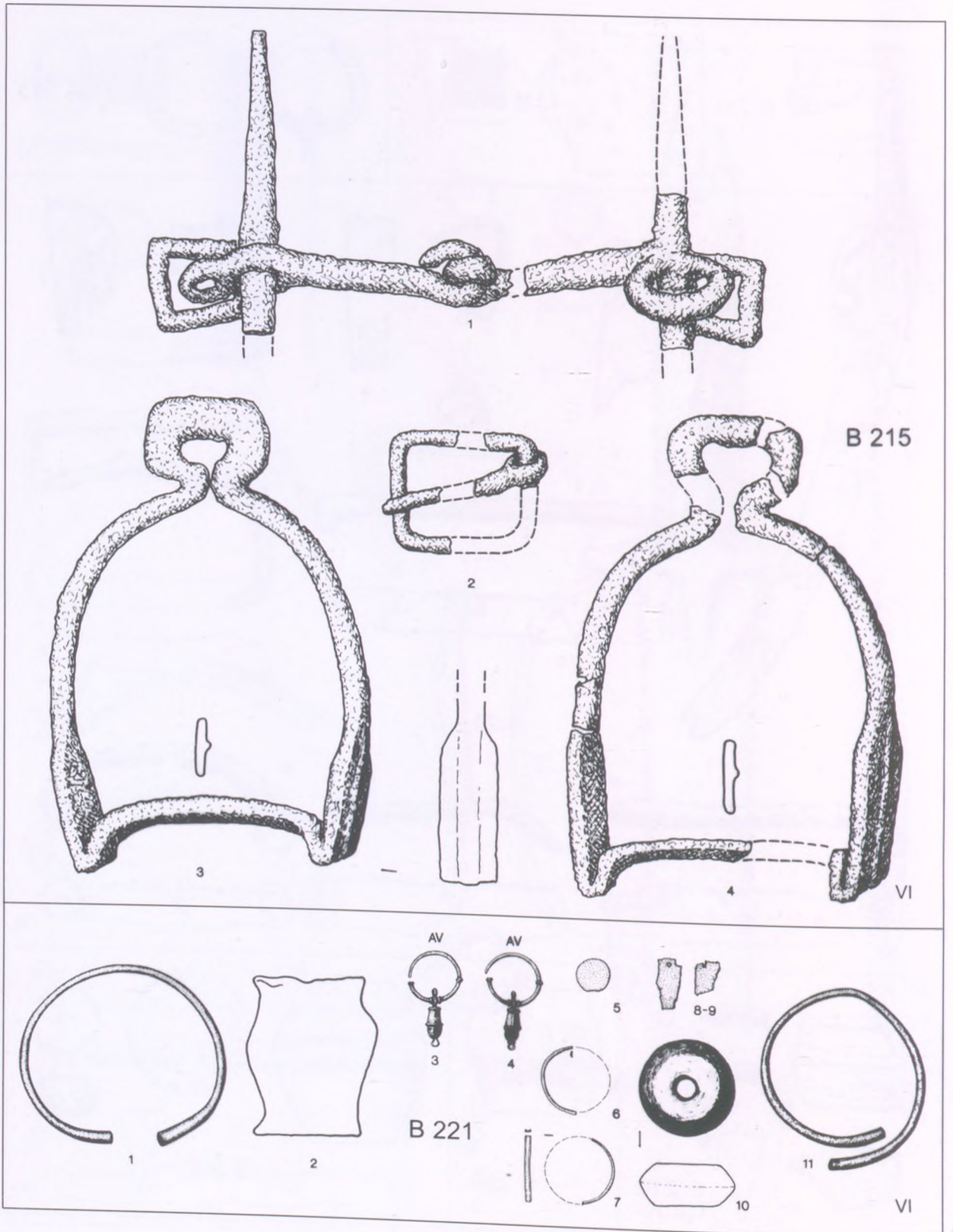

Taf. 66 Gräber 215, 221

KÖLKED - FEKETEKAJU B

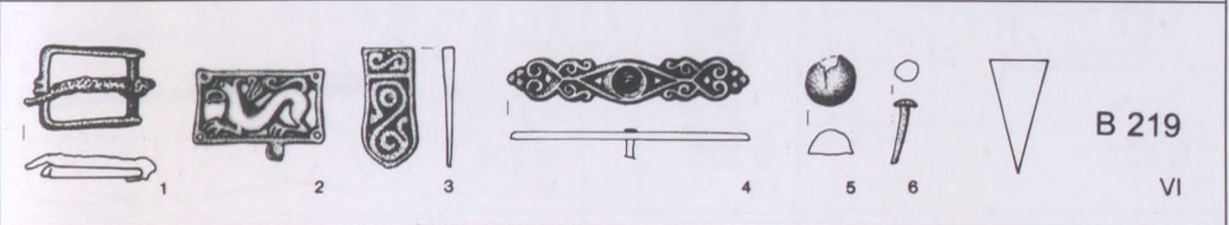
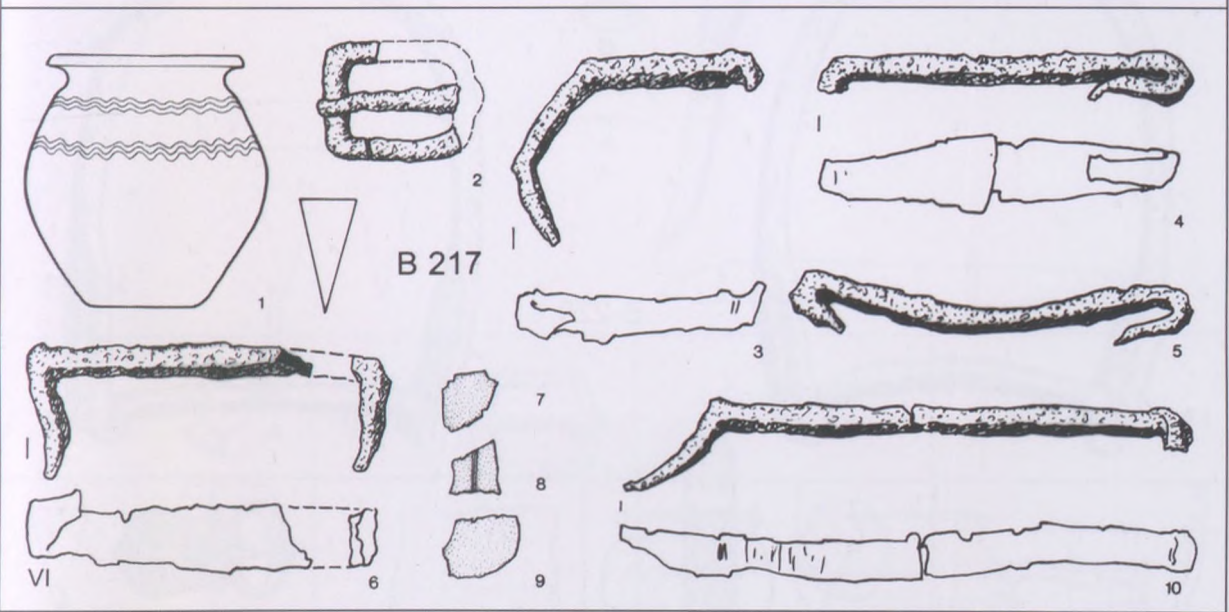
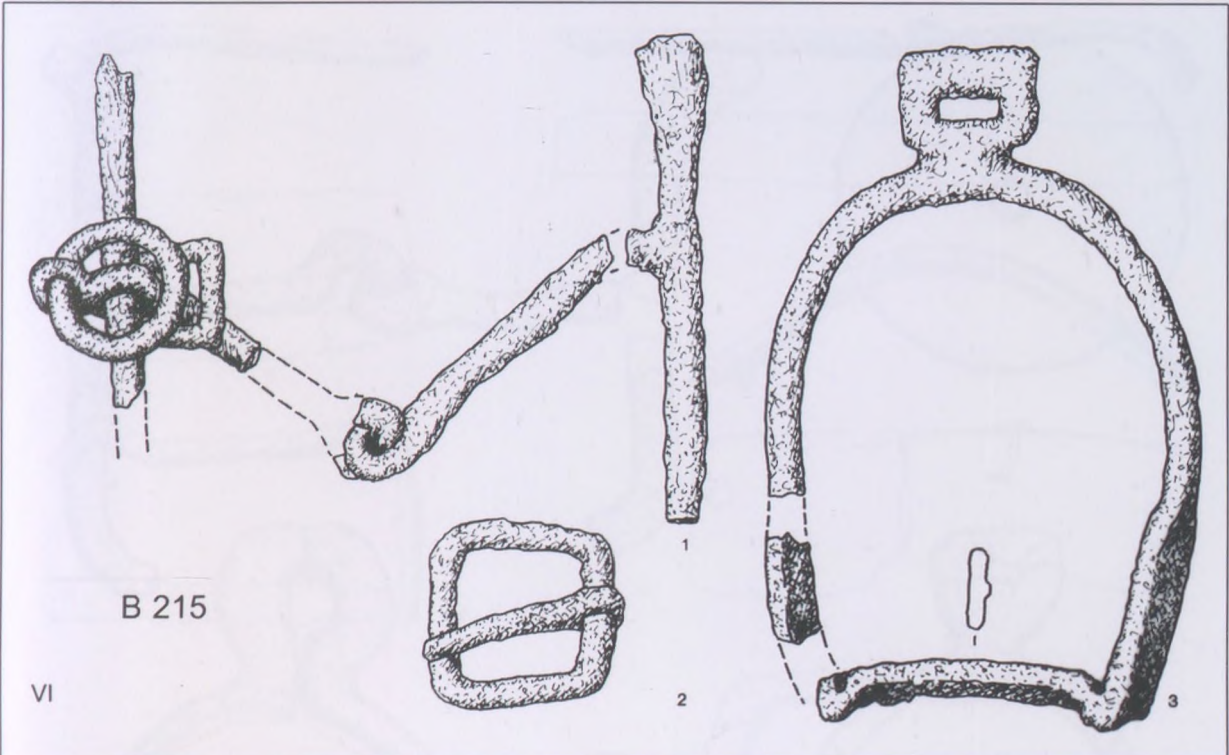

Taf. 67 Gräber 215, 217, 219

KÖLKED - FEKETEKAJU B

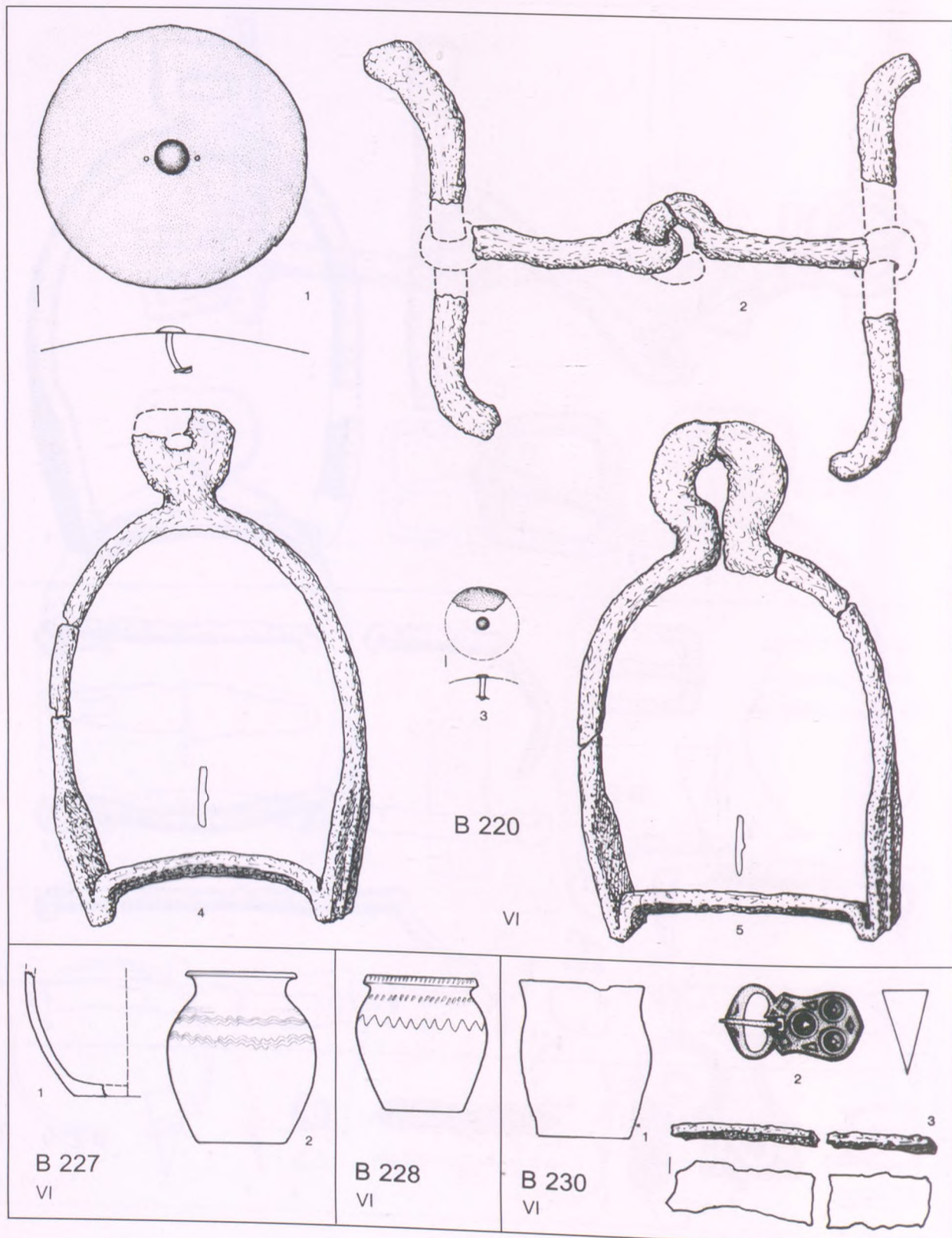

Taf. 68 Gräber 220, 227, 228, 230

KÖLKED - FEKETEKAPO B

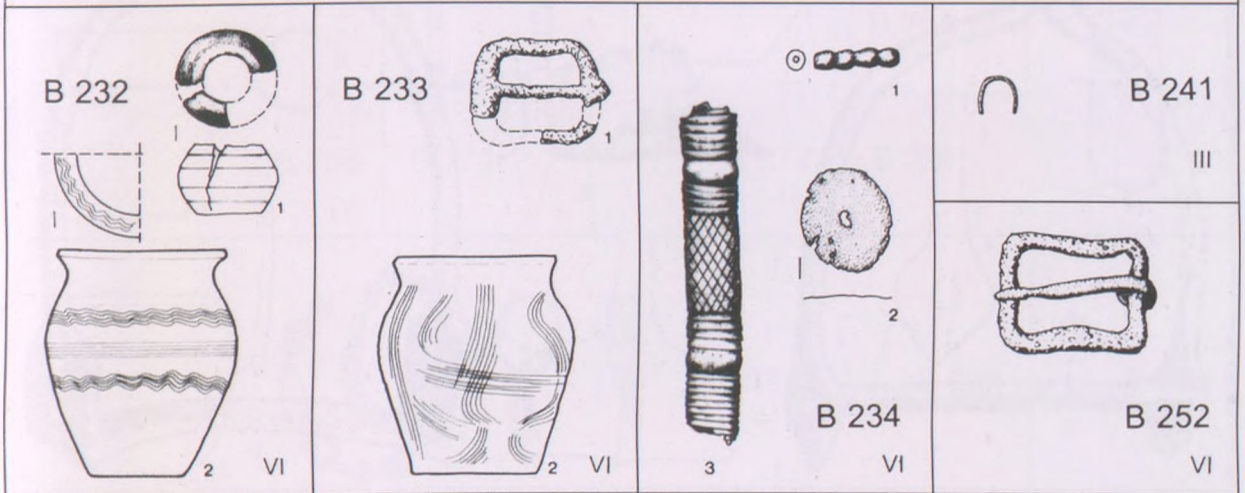
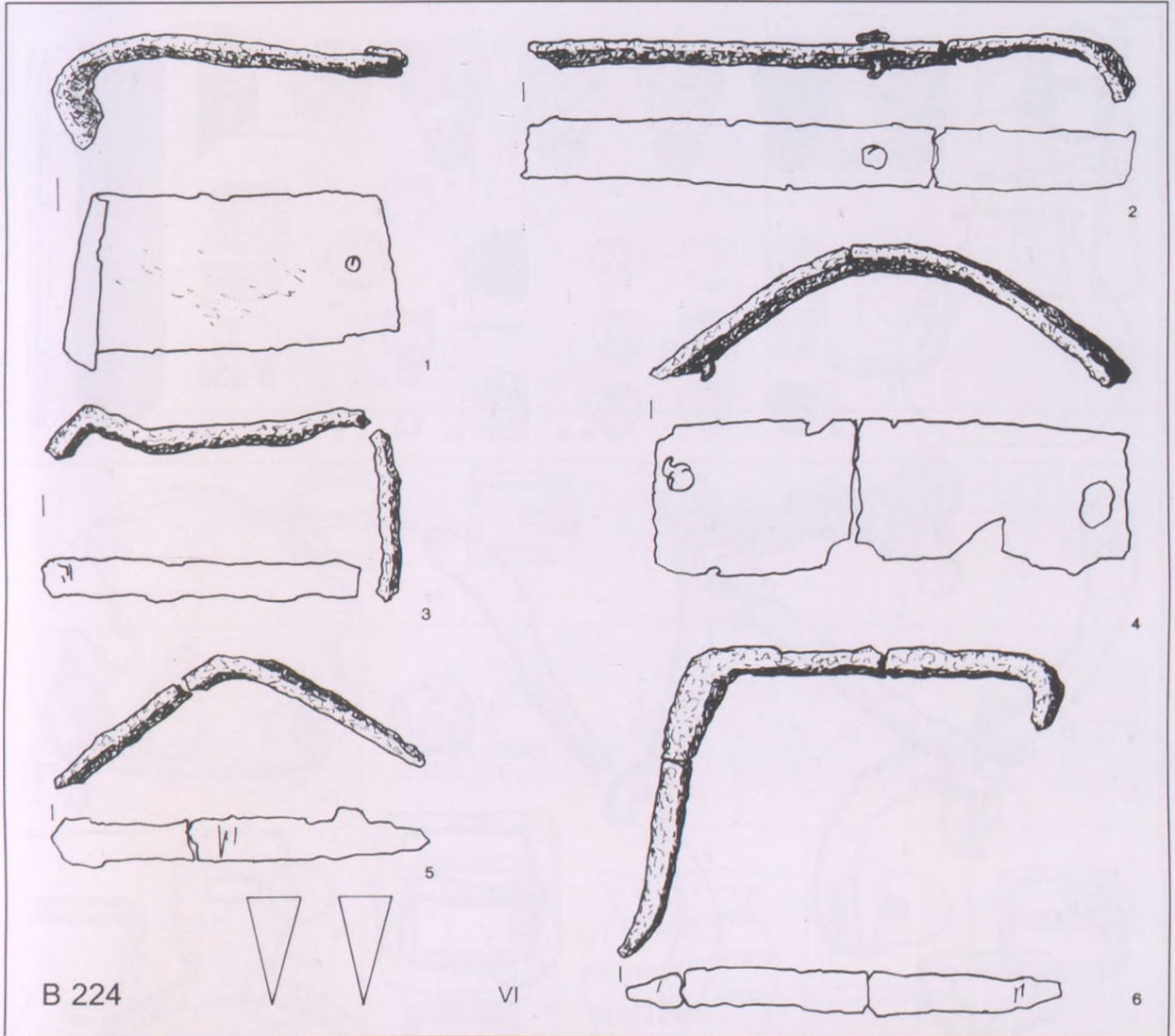

Taf. 69 Gräber 224, 232, 233, 234, 241, 252

KÖLKED – FEKETEKAJU B

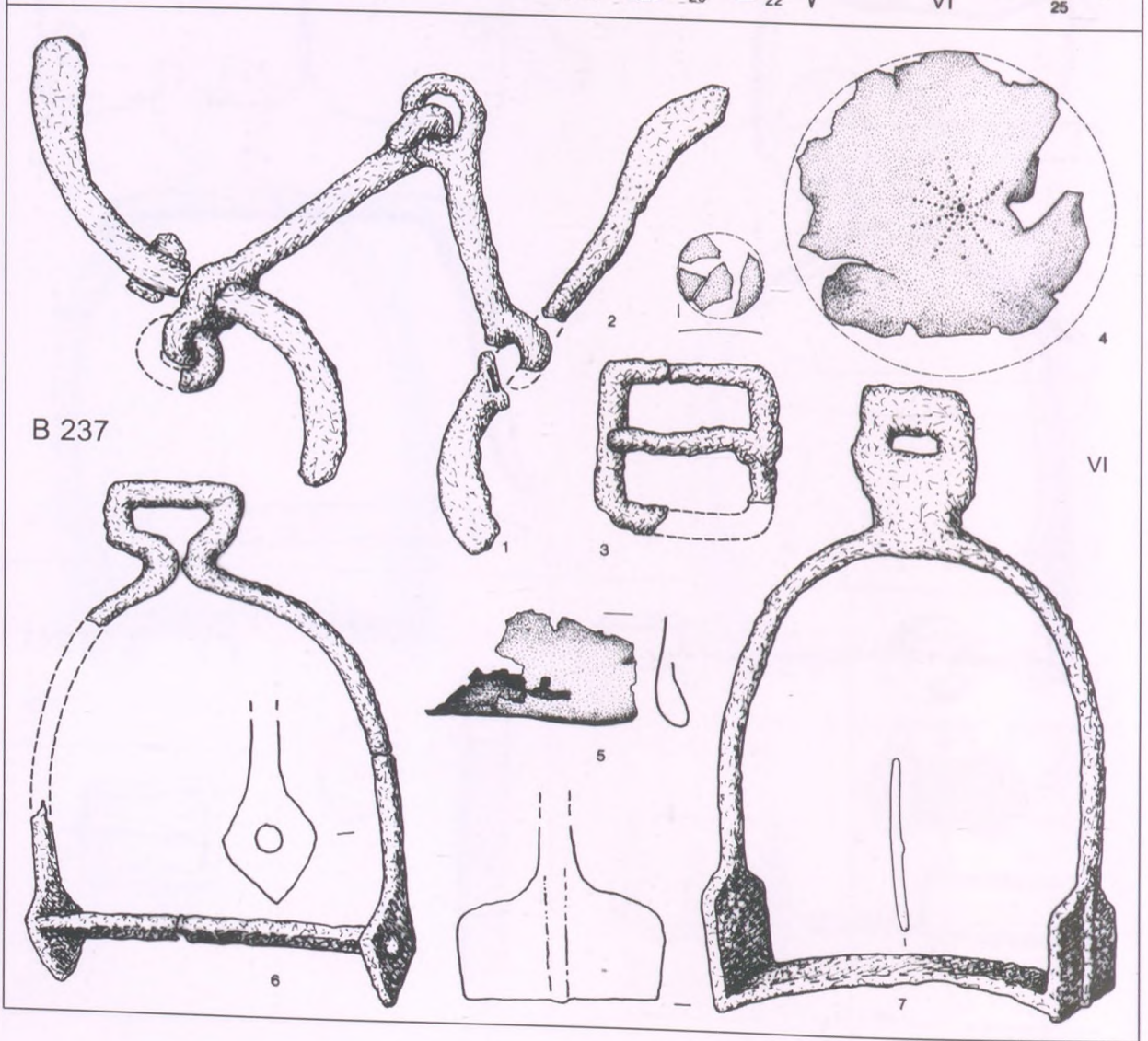
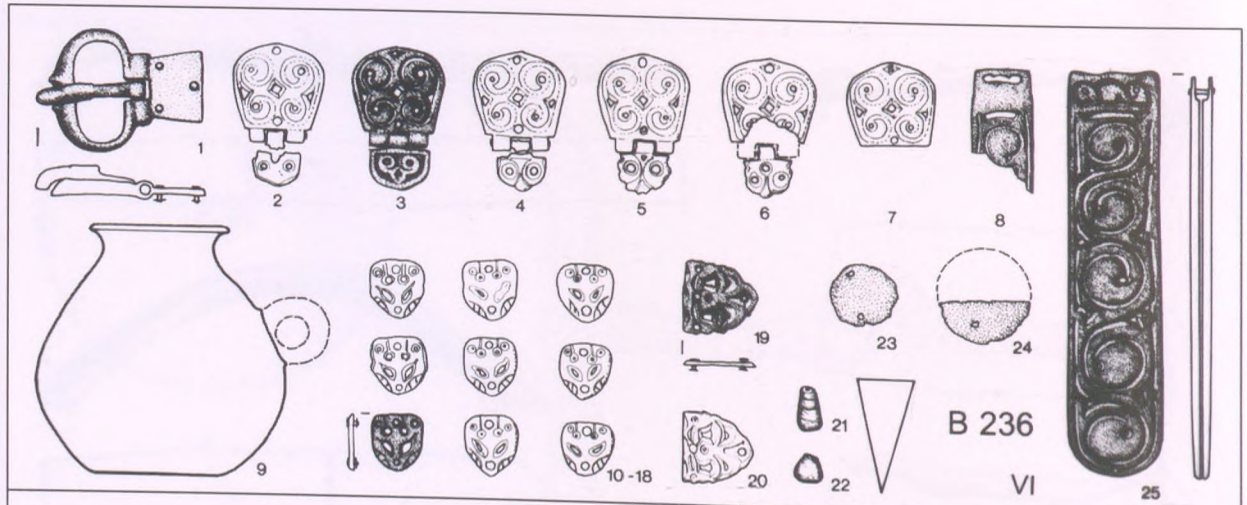

Taf. 70 Gräber 236, 237

KÖLKED – FEKETEKAJU B

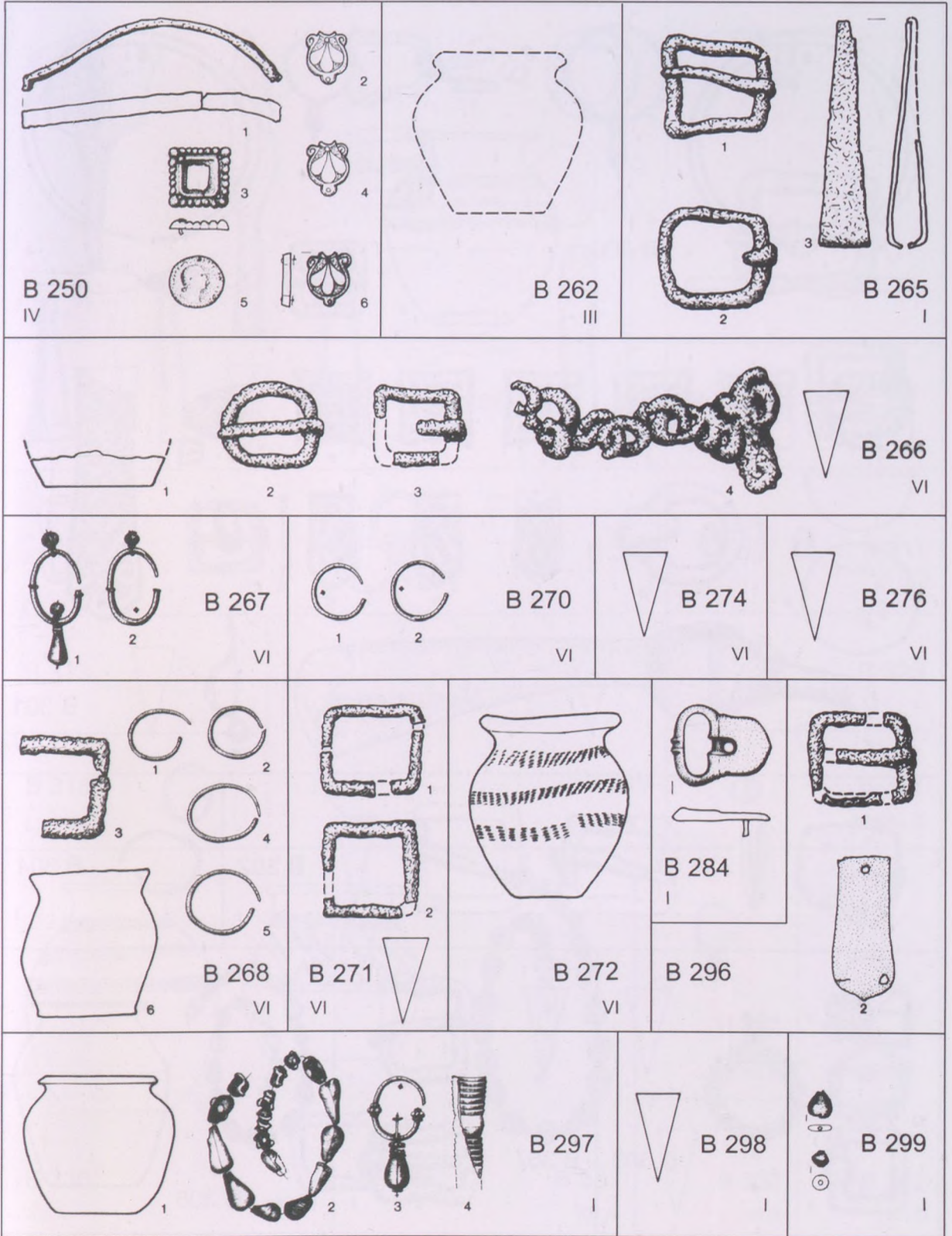

Taf. 71 Gräber 250, 262, 265, 266, 267, 268, 270, 271, 272, 274, 276, 284, 296, 297, 298, 299

KÖLKED - FEKETEKAJU B

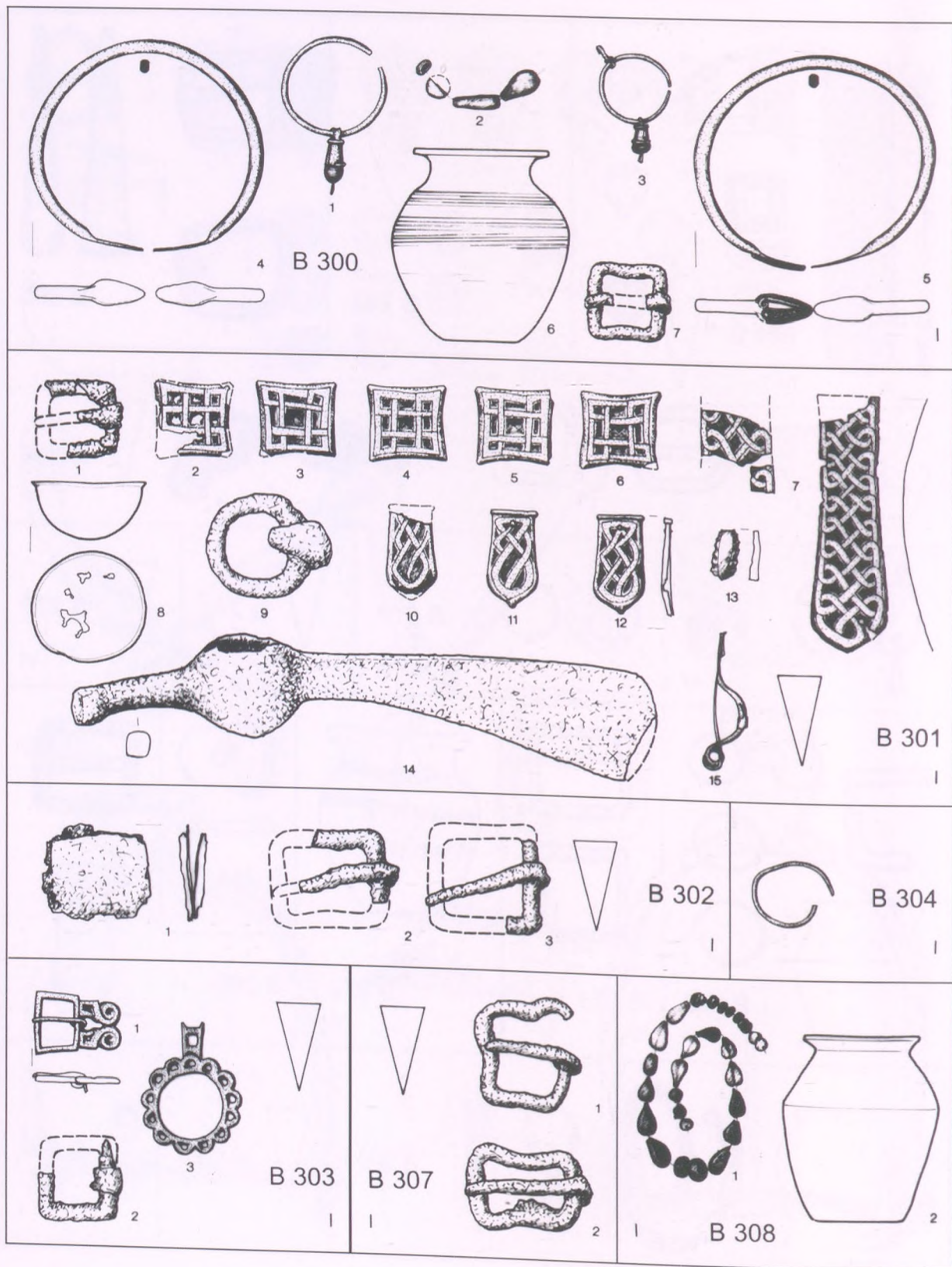

Taf. 72 Gräber 300, 301, 302, 303, 304, 307, 308

KÖLKED – FEKETEKAJU B

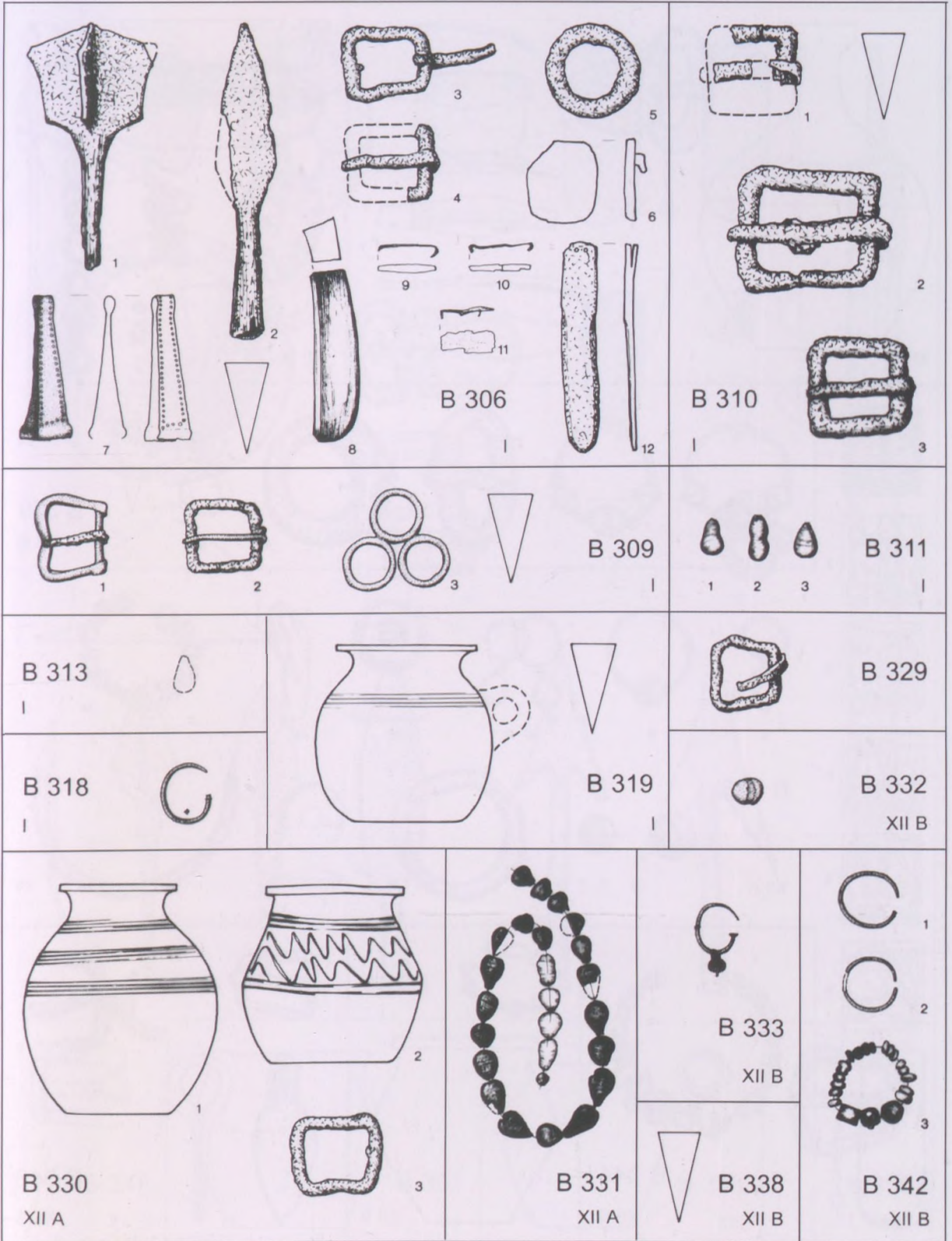

Taf. 73 Gräber 306, 309, 310, 311, 313, 318, 319, 329, 330, 331, 332, 333, 338, 342

KÖLKED – FEKETEKAPO B

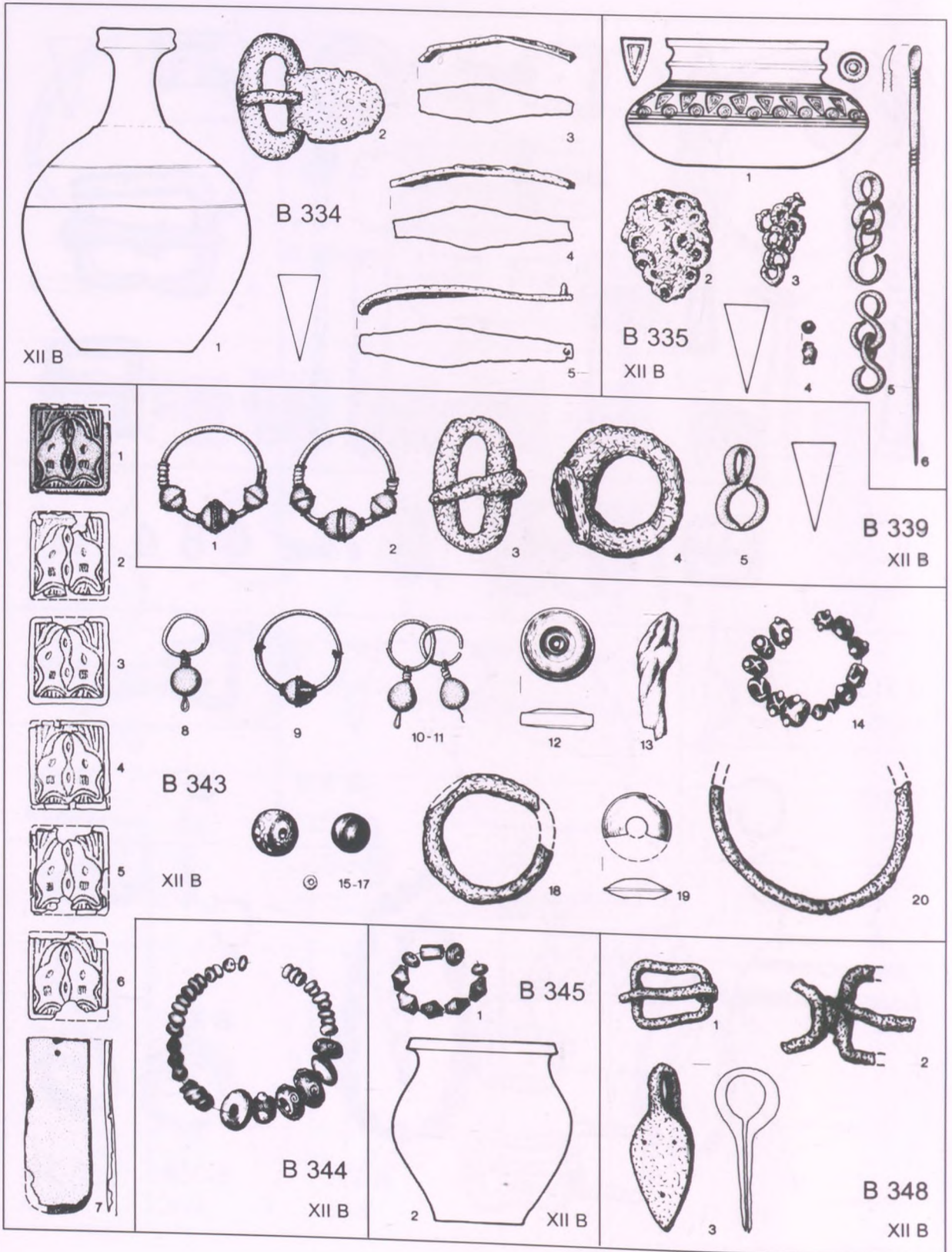

Taf. 74 Gräber 334, 335, 339, 343, 344, 345, 348

KÖLKED – FEKETEKAJU B

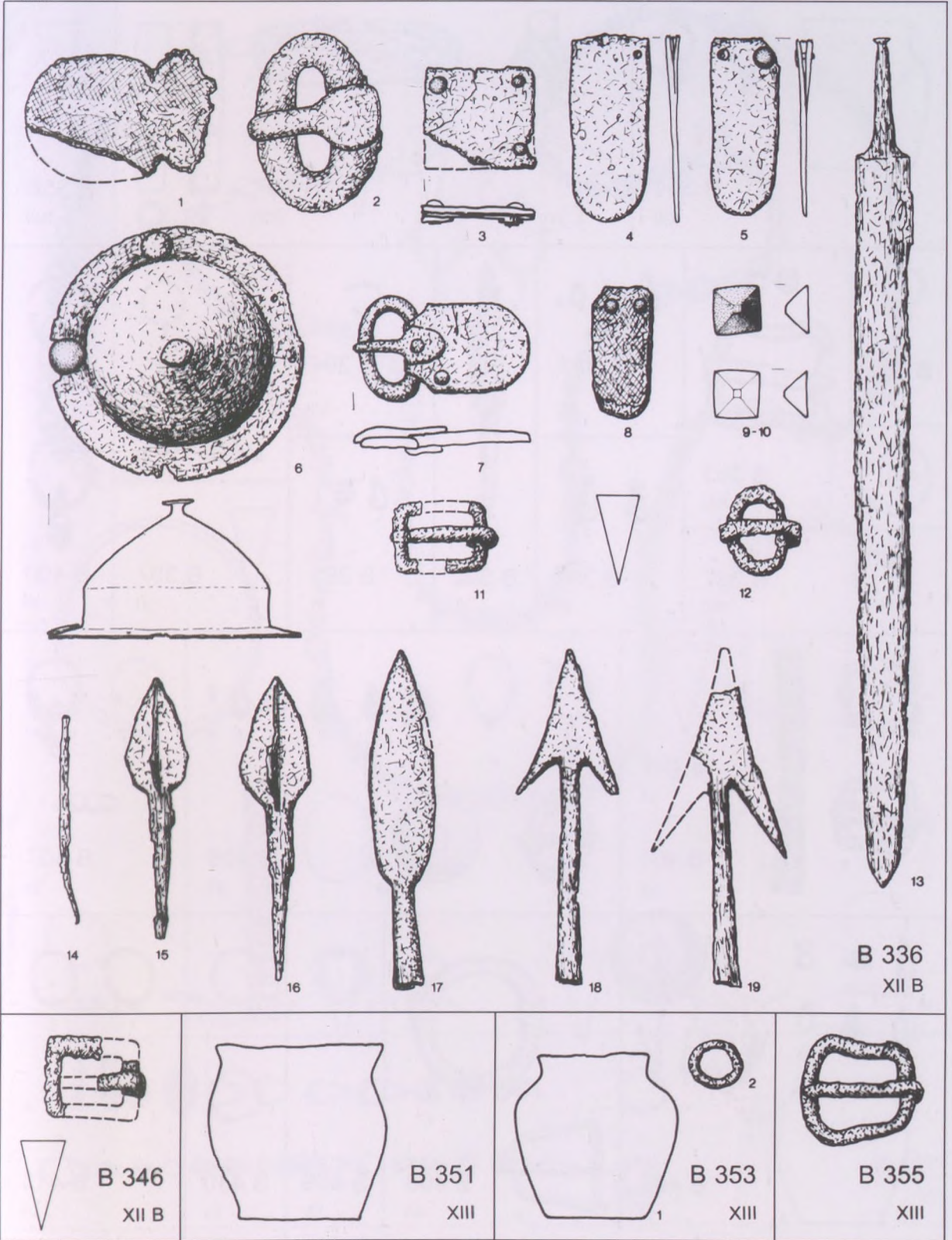

Taf. 75 Gräber 336, 346, 351, 353, 355

KÖLKED – FEKETEKAJU B

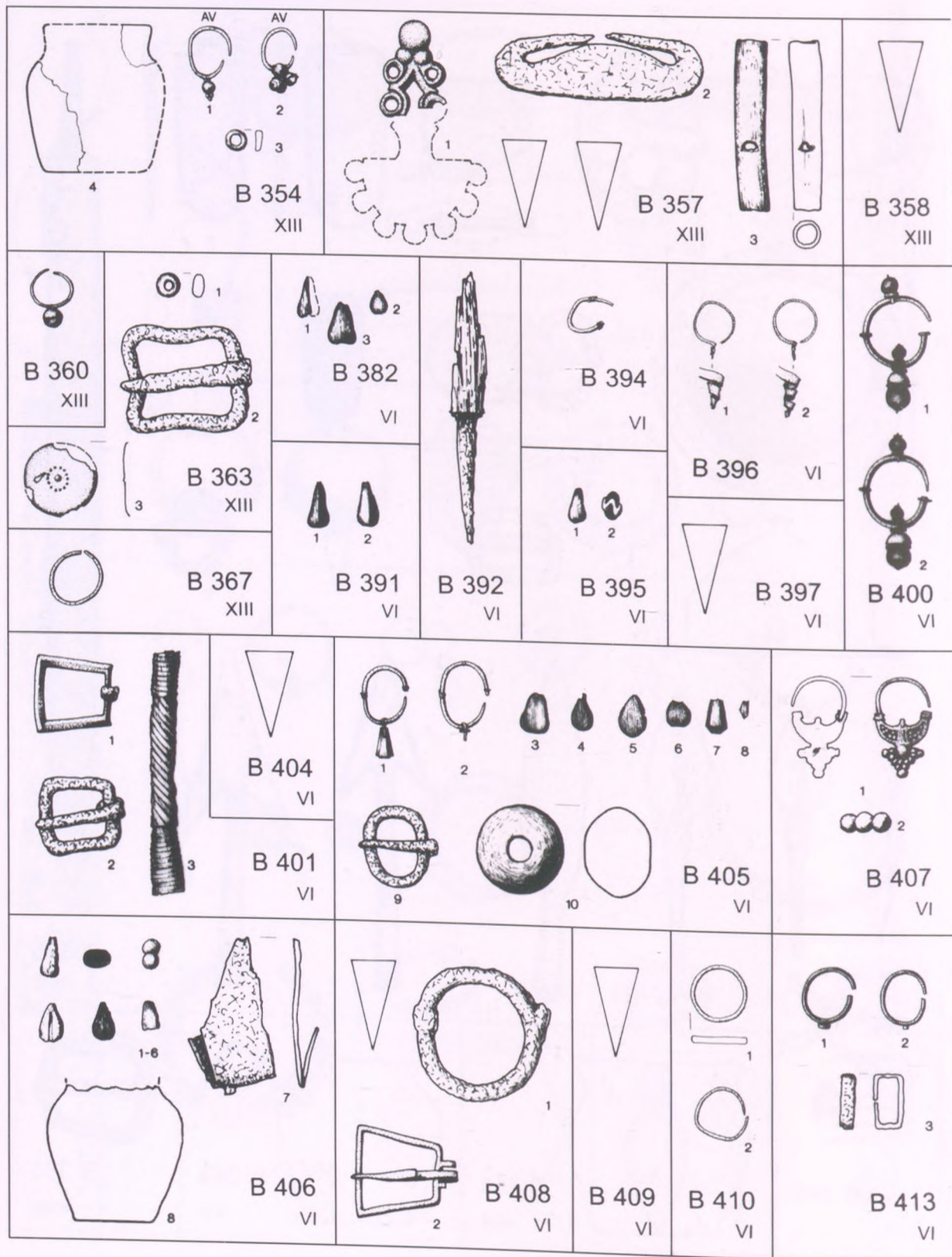

Taf. 76 Gräber 354, 357, 358, 360, 363, 367, 382, 391, 392, 394, 395, 396, 397, 400, 401, 404, 405, 406, 407, 408, 409, 410, 413

KÖLKED – FEKETEKAPO B

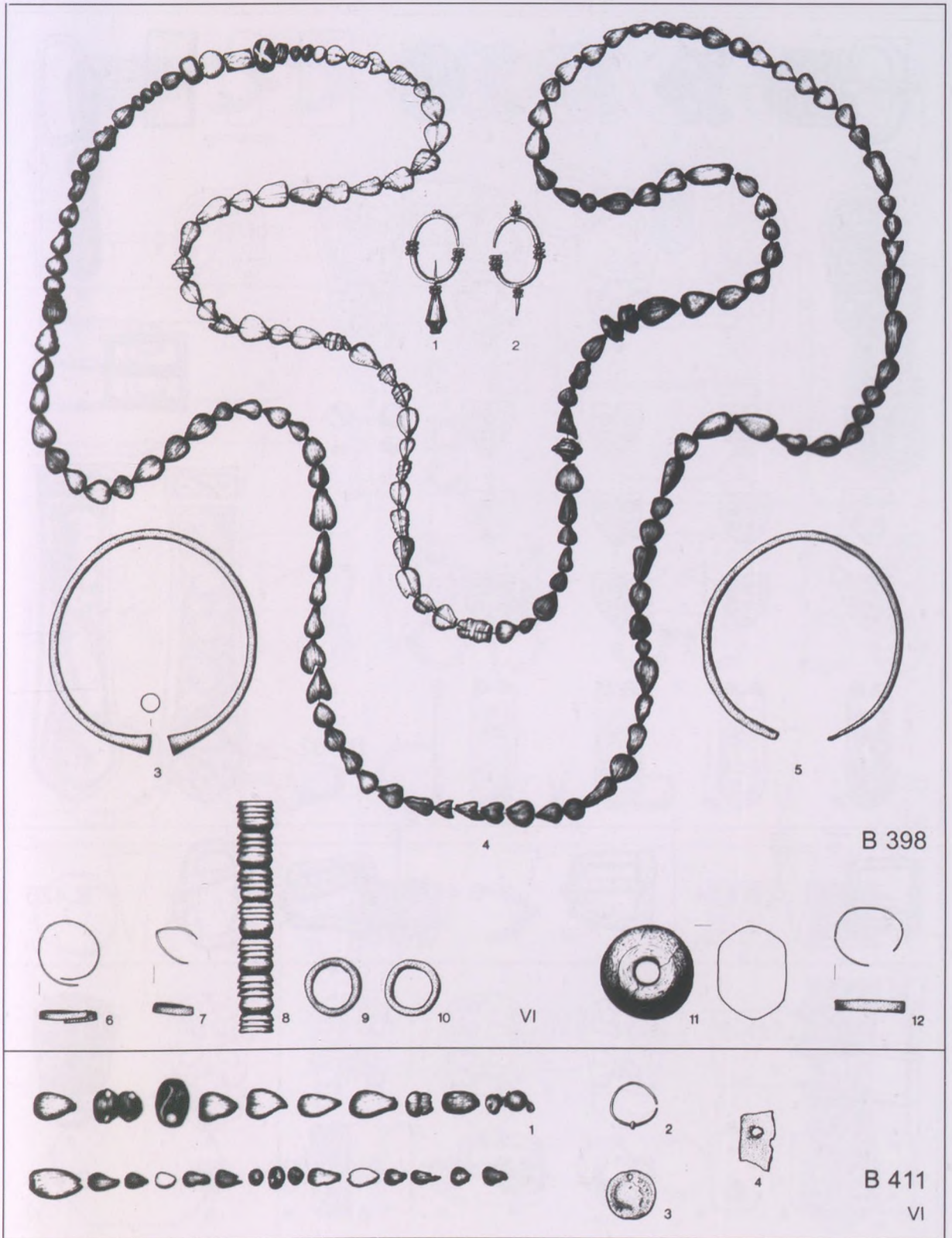

Taf. 77 Gräber 398, 411

KÖLKED – FEKETEKAJU B

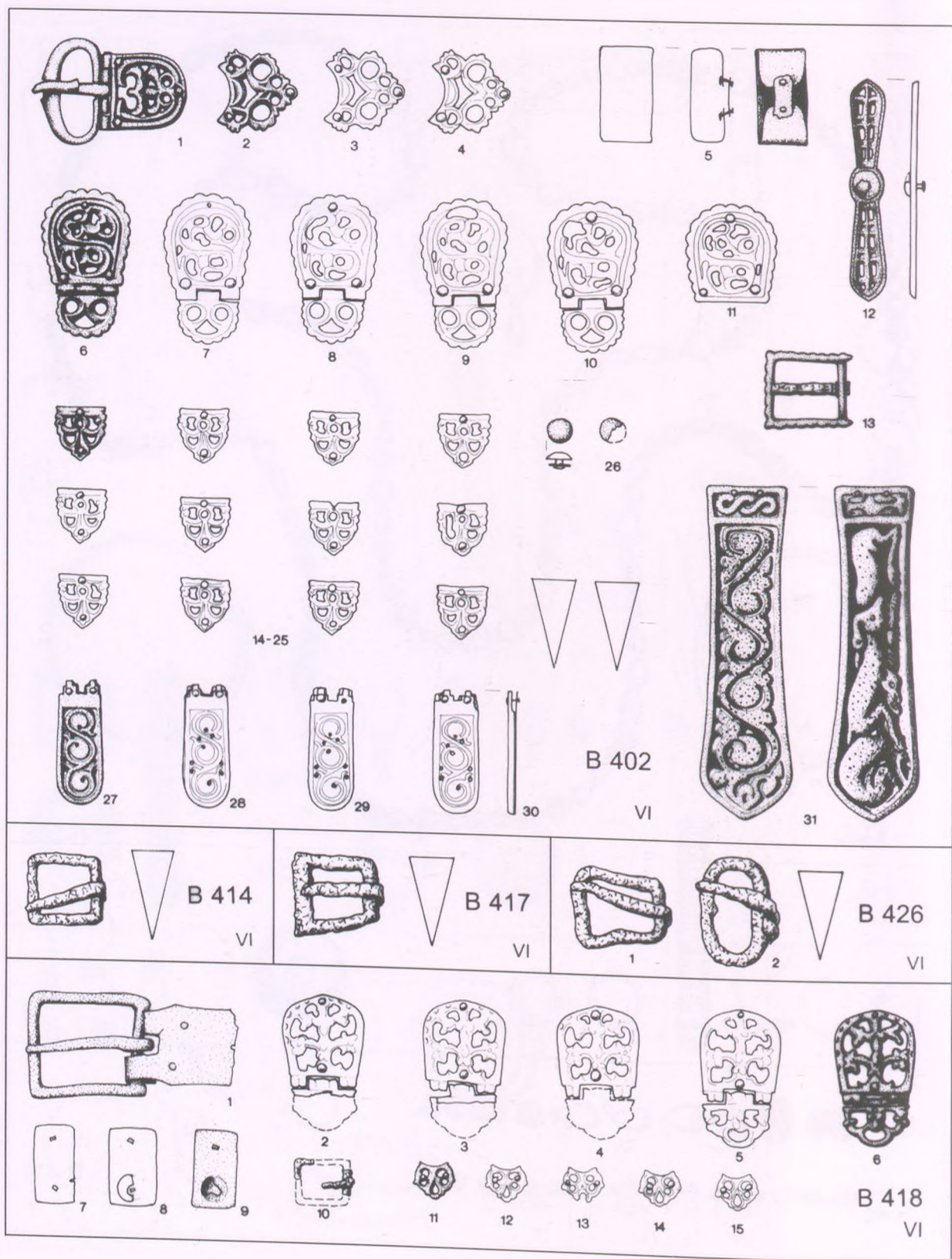

Taf. 78 Gräber 402, 414, 417, 418, 426

KÖLKED – FEKETEKAPO B

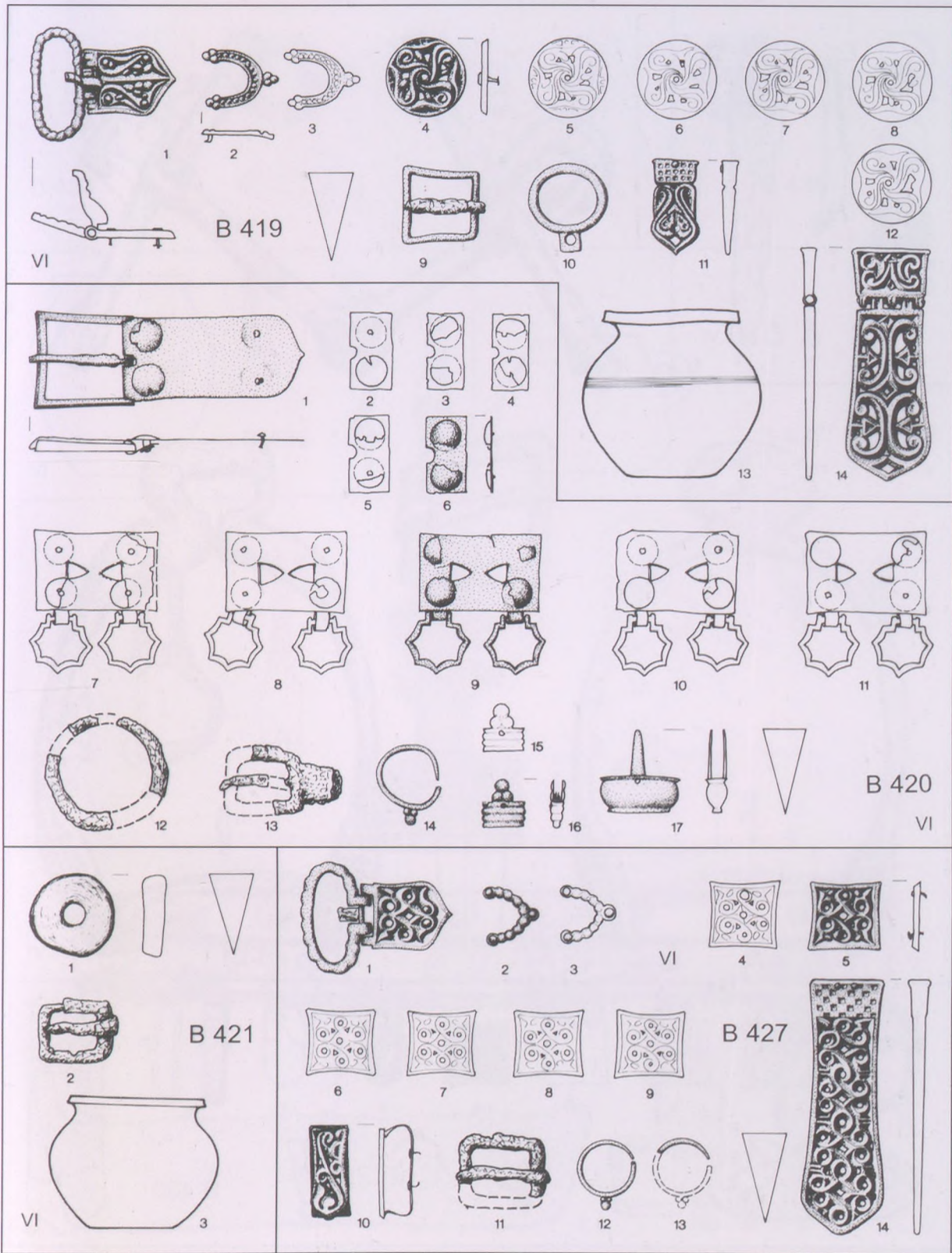

Taf. 79 Gräber 419, 420, 421, 427

KÖLKED – FEKETEKAJU B

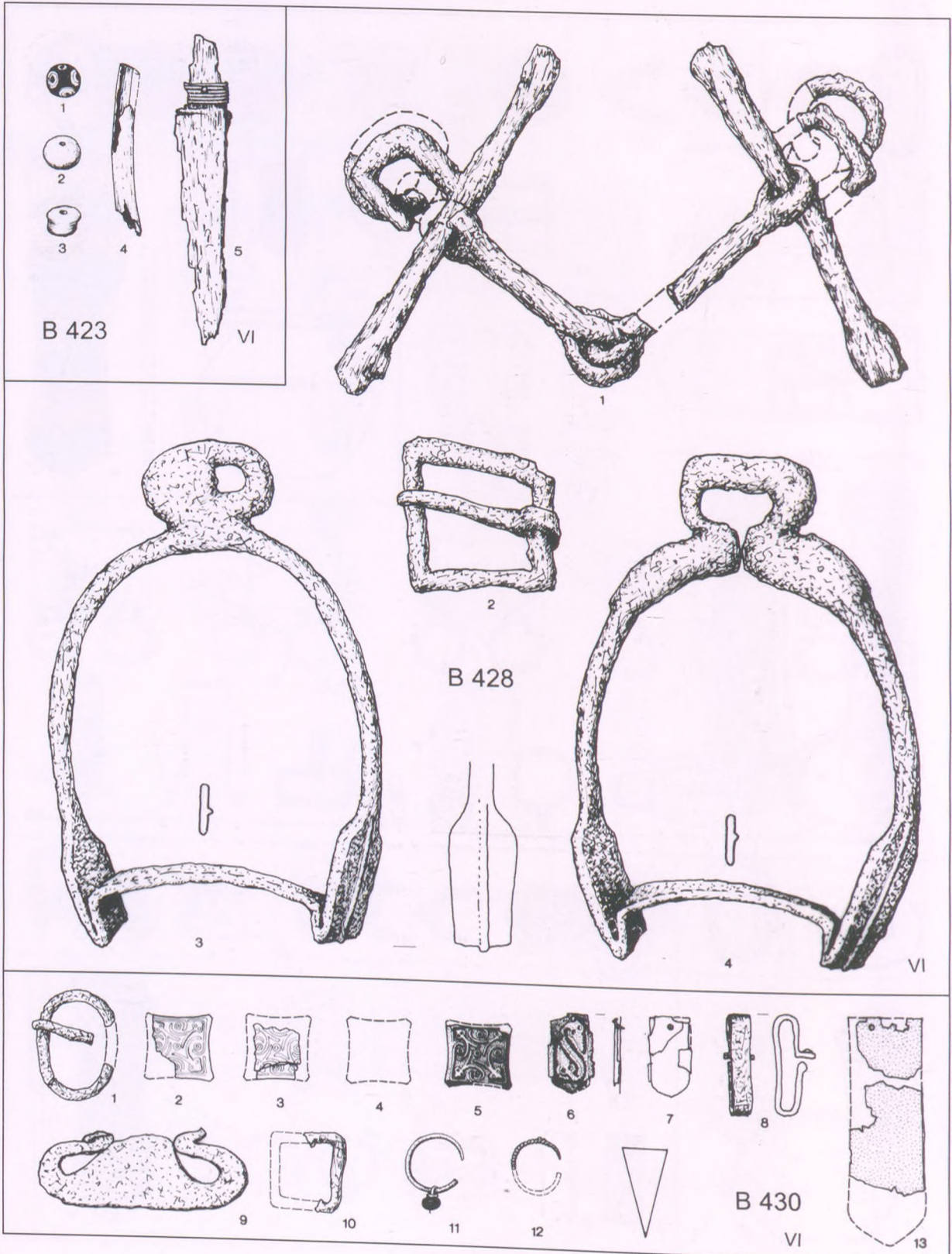

Taf. 80 Gräber 423, 428, 430

KÖLKED – FEKETEKAPO B

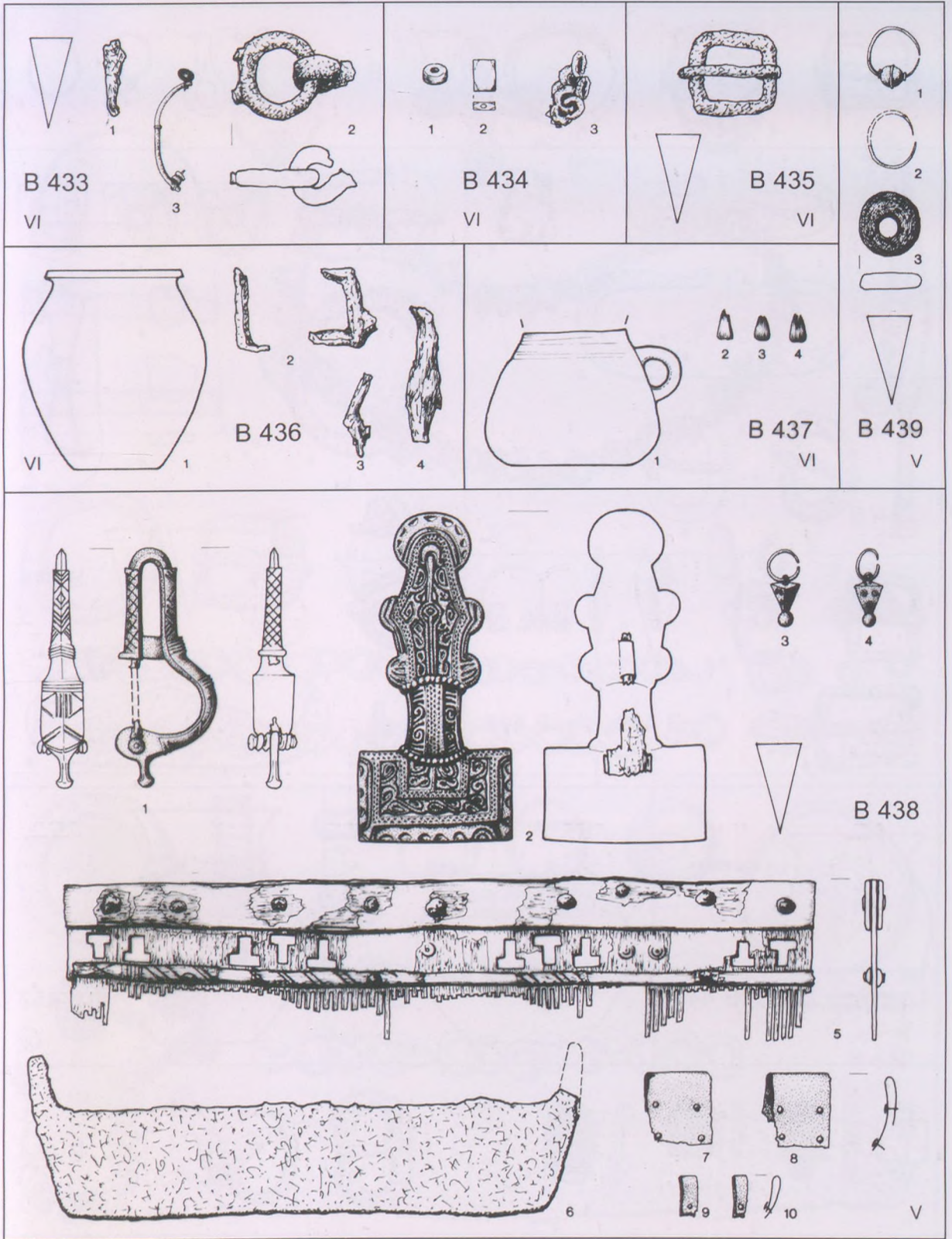

Taf. 81 Gräber 433, 434, 435, 436, 437, 438, 439

KÖLKED – FEKETEKAJU B

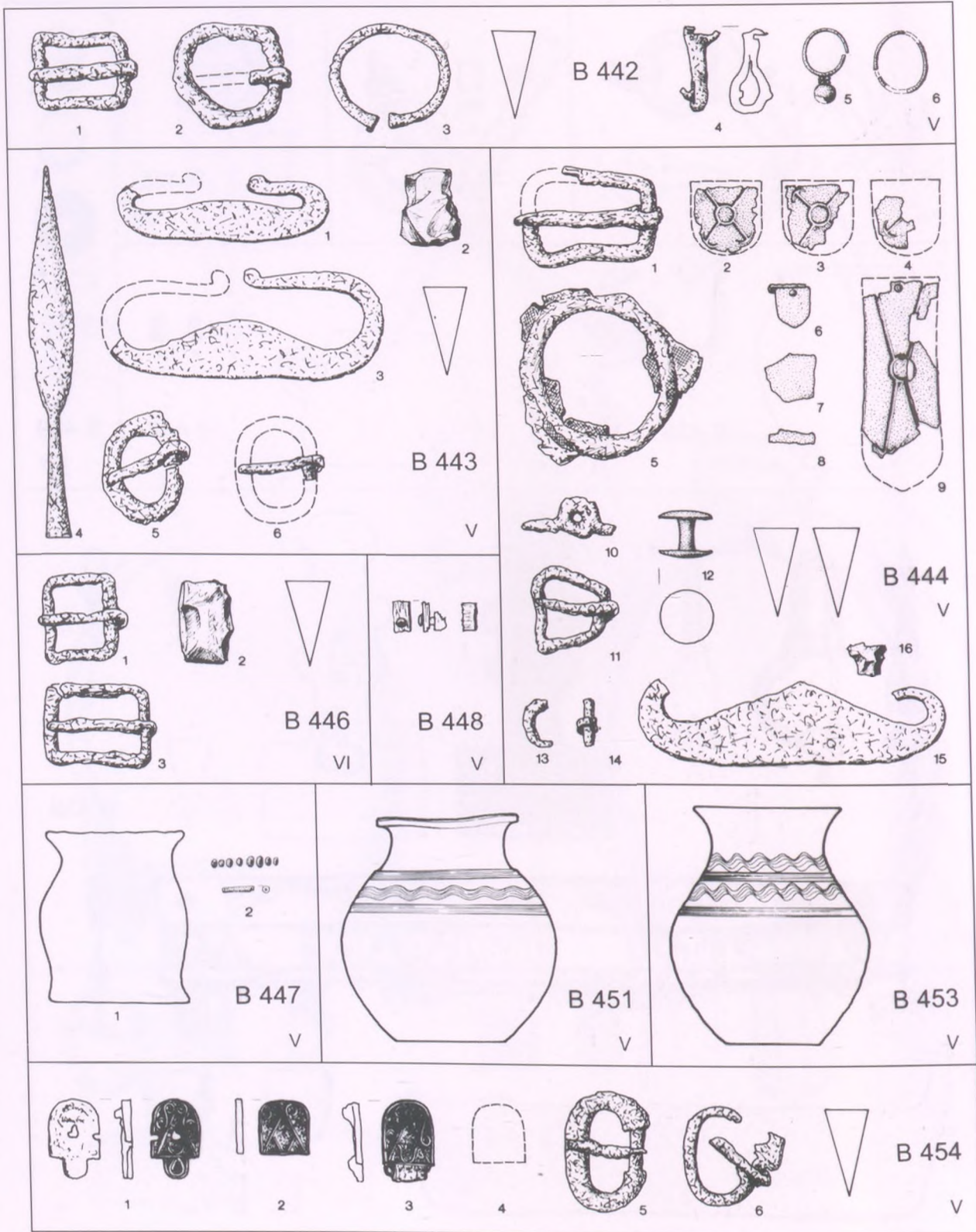

Taf. 82 Grüber 442, 443, 444, 446, 447, 448, 451, 453, 454

KÖLKED - FEKETEKAJU B

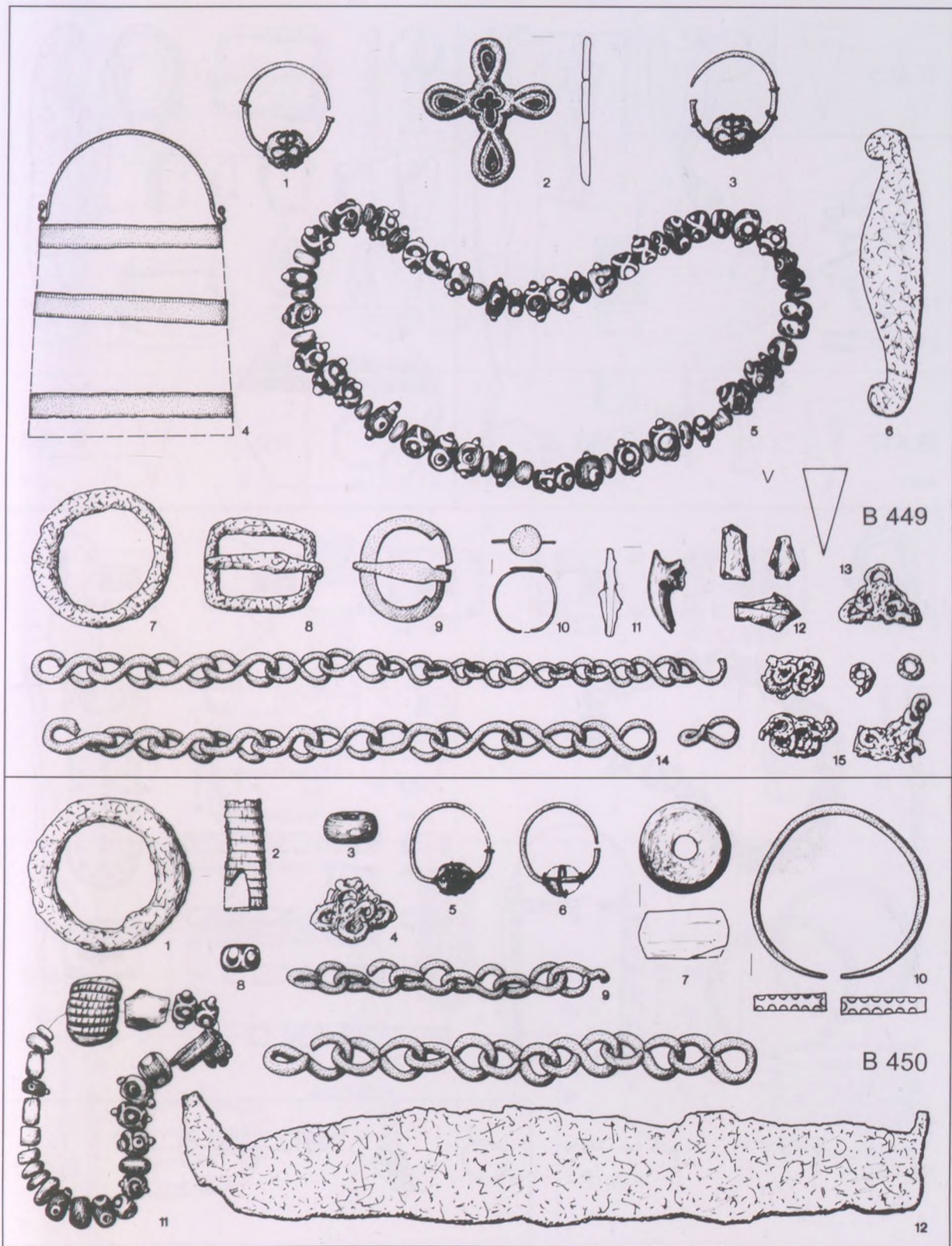

Taf. 83 Gräber 449, 450

KÖLKED – FEKETEKAJU B

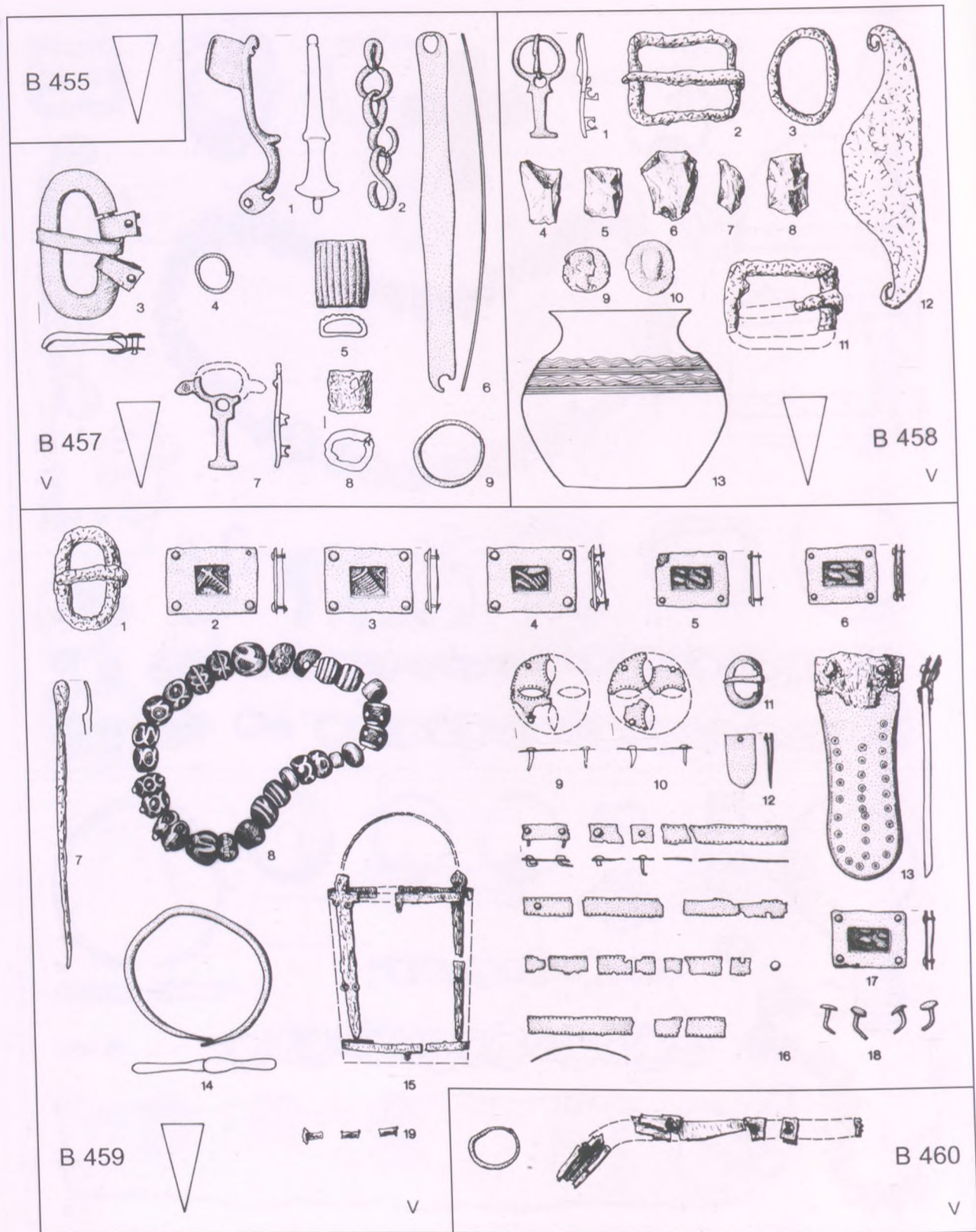

Taf. 84 Gräber 455, 457, 458, 459, 460

KÖLKED – FEKETEKAPO B

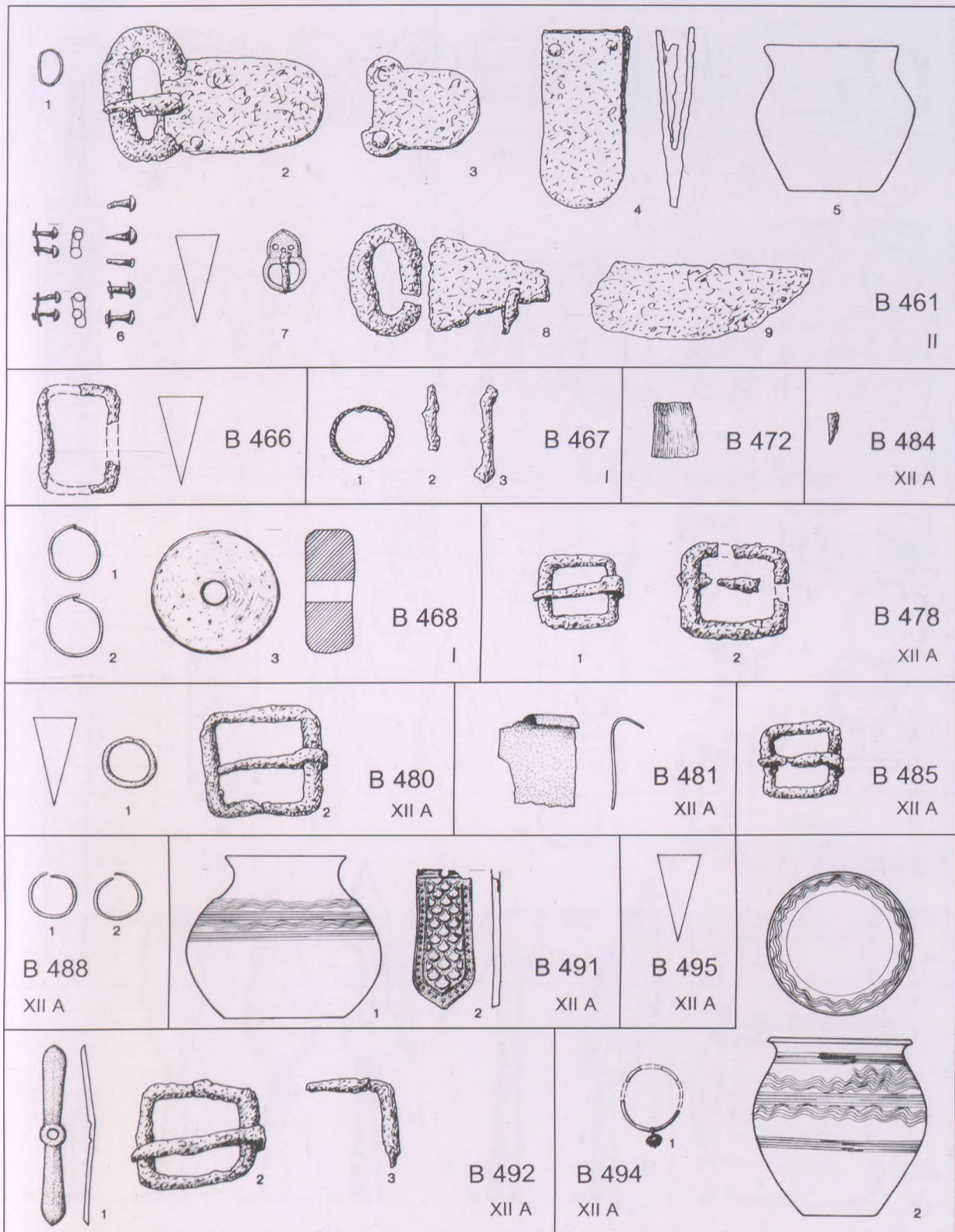

Taf. 85 Gräber 461, 466, 467, 468, 472, 478, 480, 481, 484, 485, 488, 491, 492, 494, 495

KÖLKED – FEKETEKAJU B

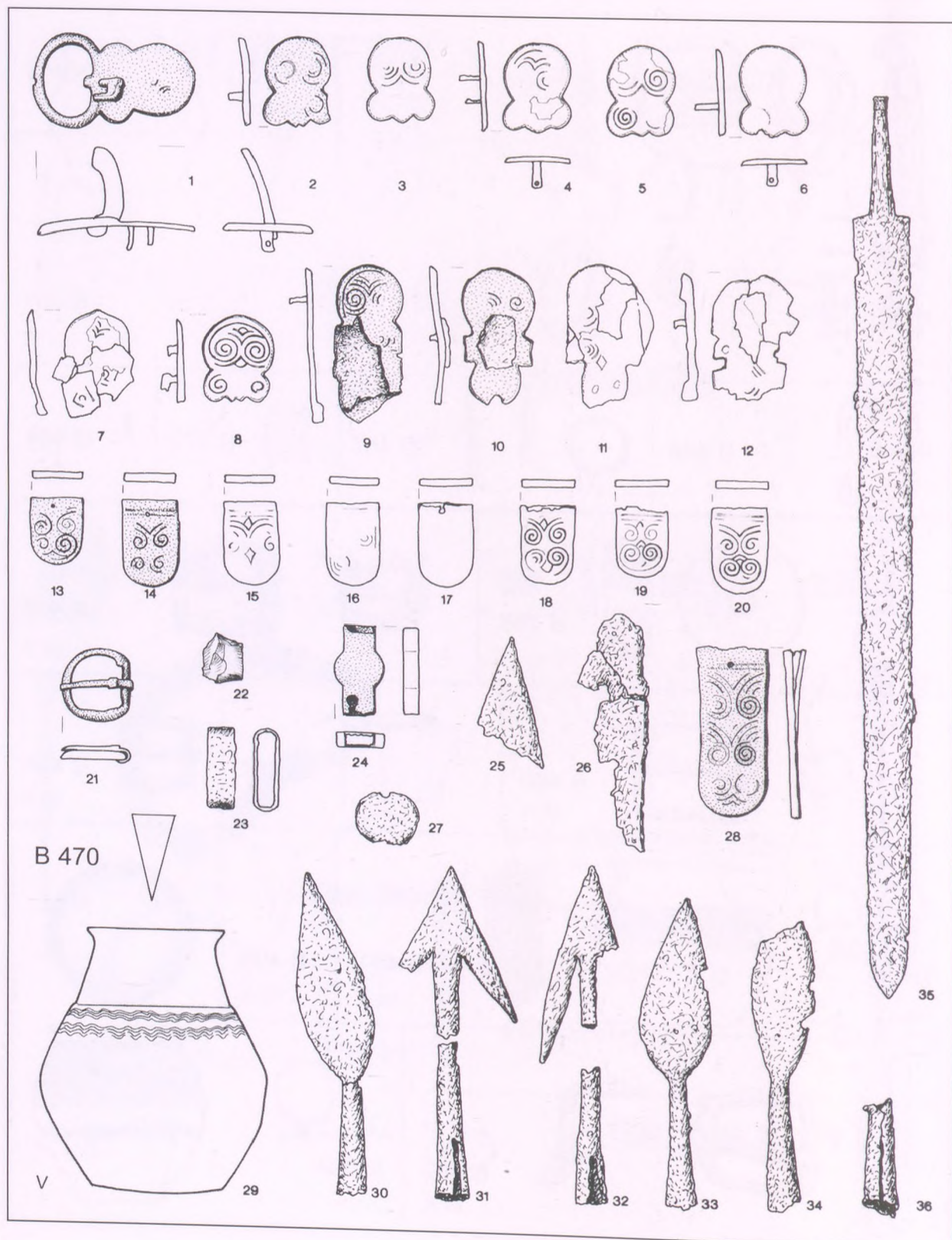

Taf. 86 Grab 470

KÖLKED – FEKETEKAPO B

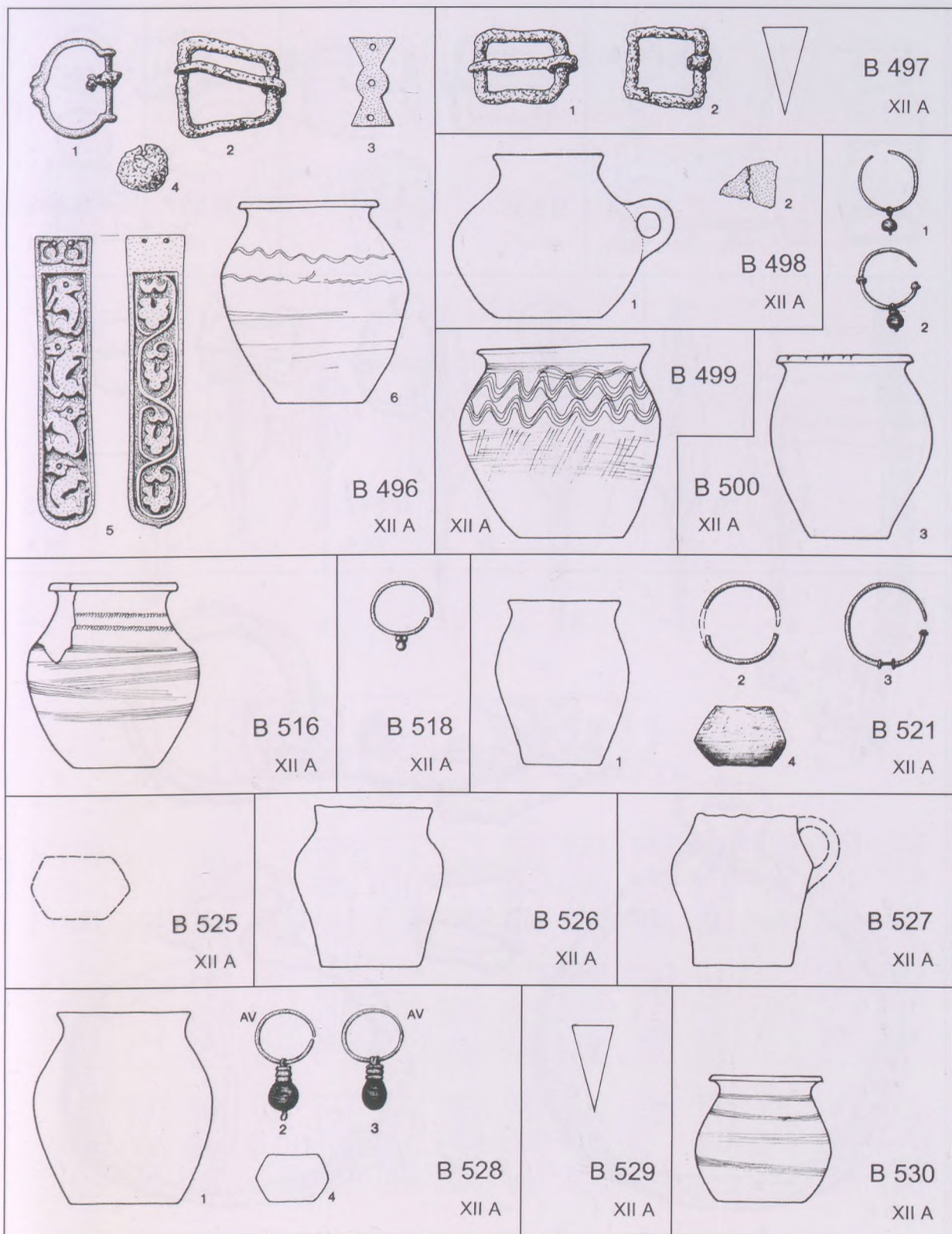

Taf. 87 Gräber 496, 497, 498, 499, 500, 516, 518, 521, 525, 526, 527, 528, 529, 530

KÖLKED – FEKETEKAPOU B

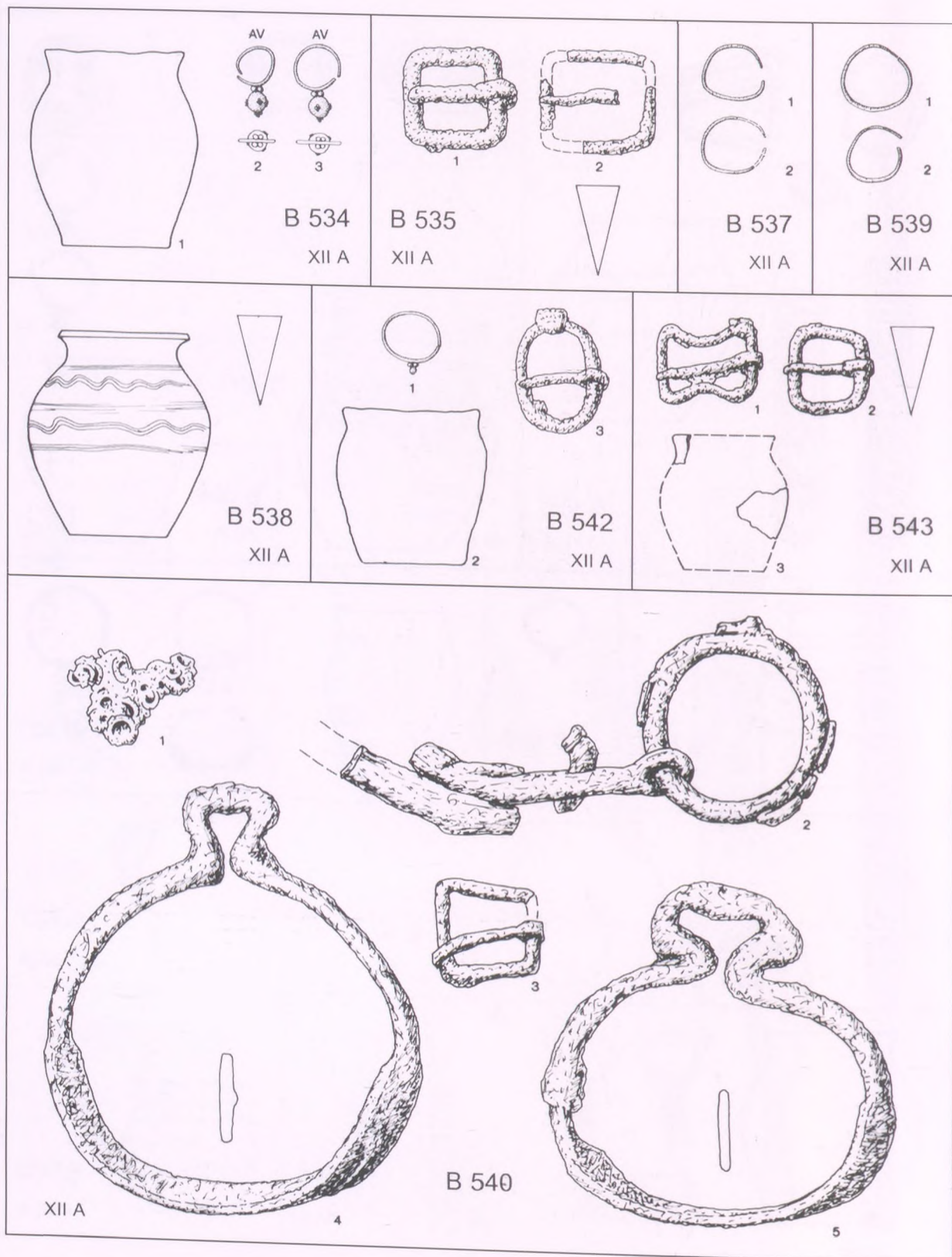

Taf. 88 Gräber 534, 535, 537, 538, 539, 540, 542, 543

KÖLKED – FEKETEKAPO B

B 541

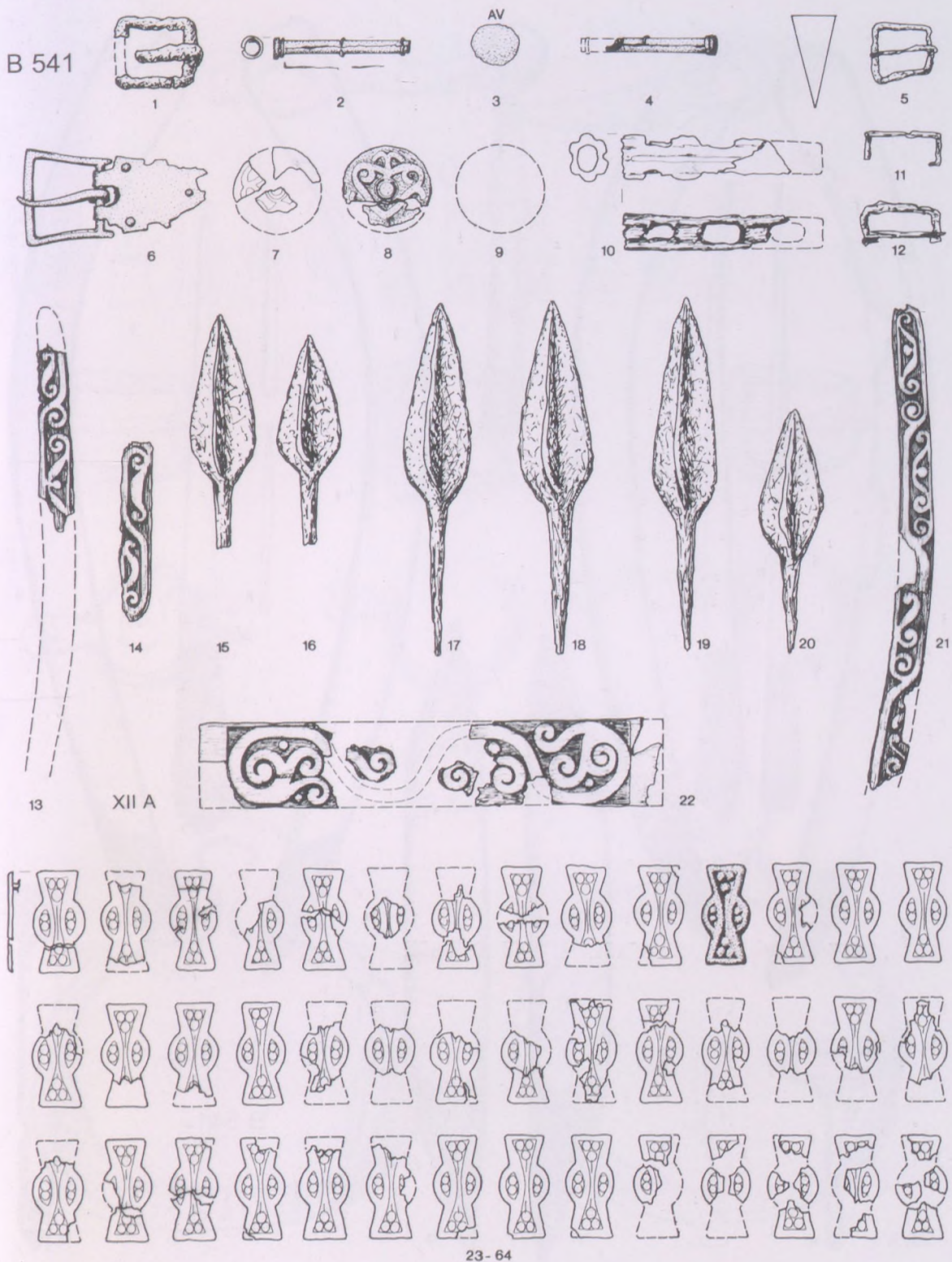

Taf. 89 Grab 541

KÖLKED - FEKETE KAPU B

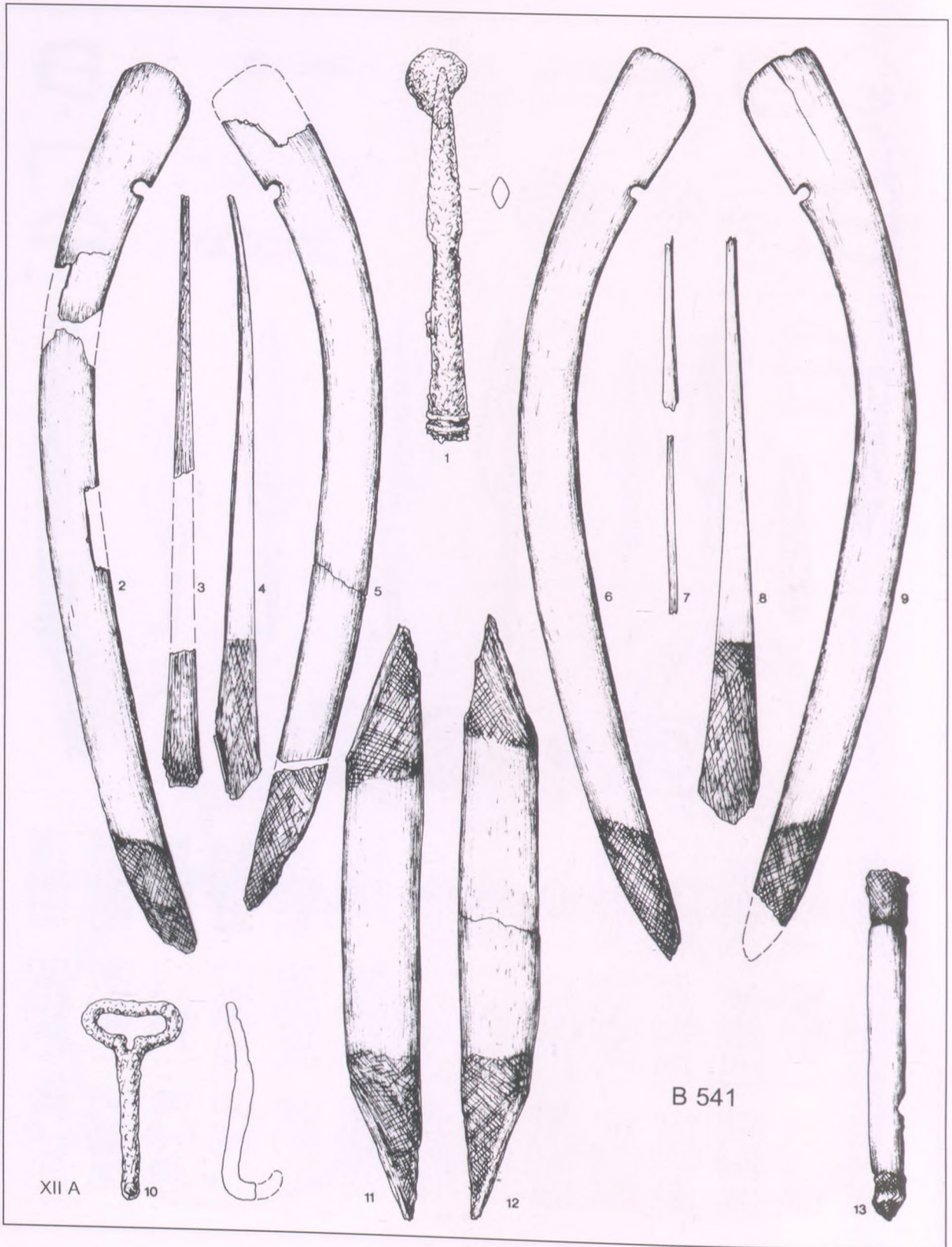

Taf. 90 Grab 541

KÖLKED – FEKETEKAPO B



1

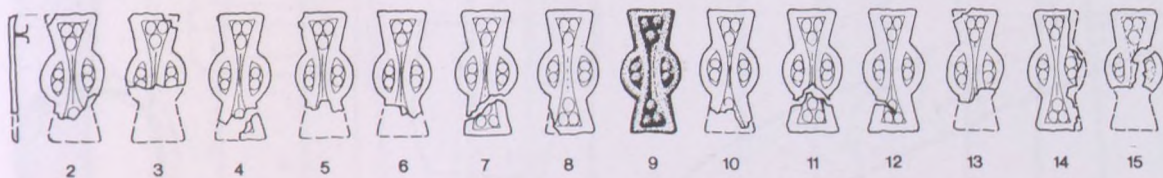

2

3

4

5

6

7

8

9

10

11

12

13

14

15



16



17



18



19

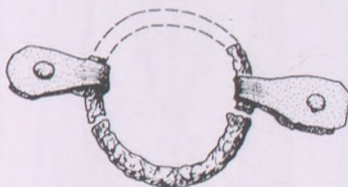

20

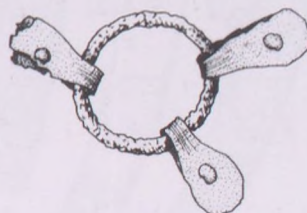

21

B 541

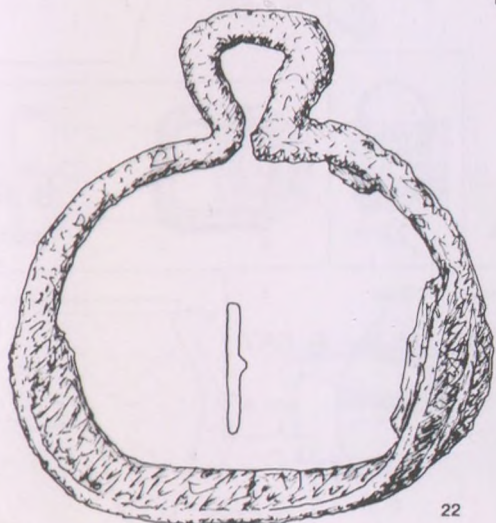

22

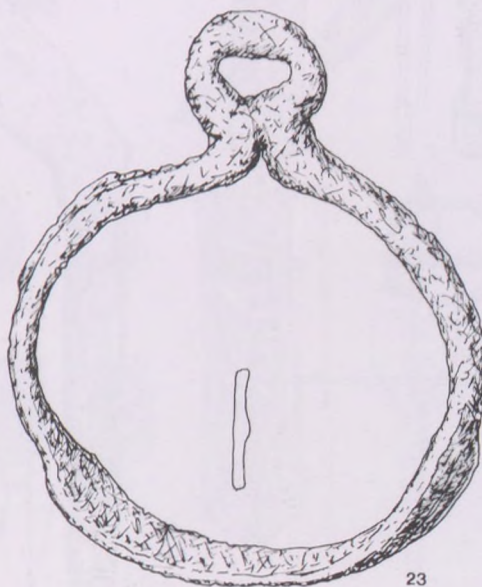

23

XII A

KÖLKED – FEKETEKAPO B

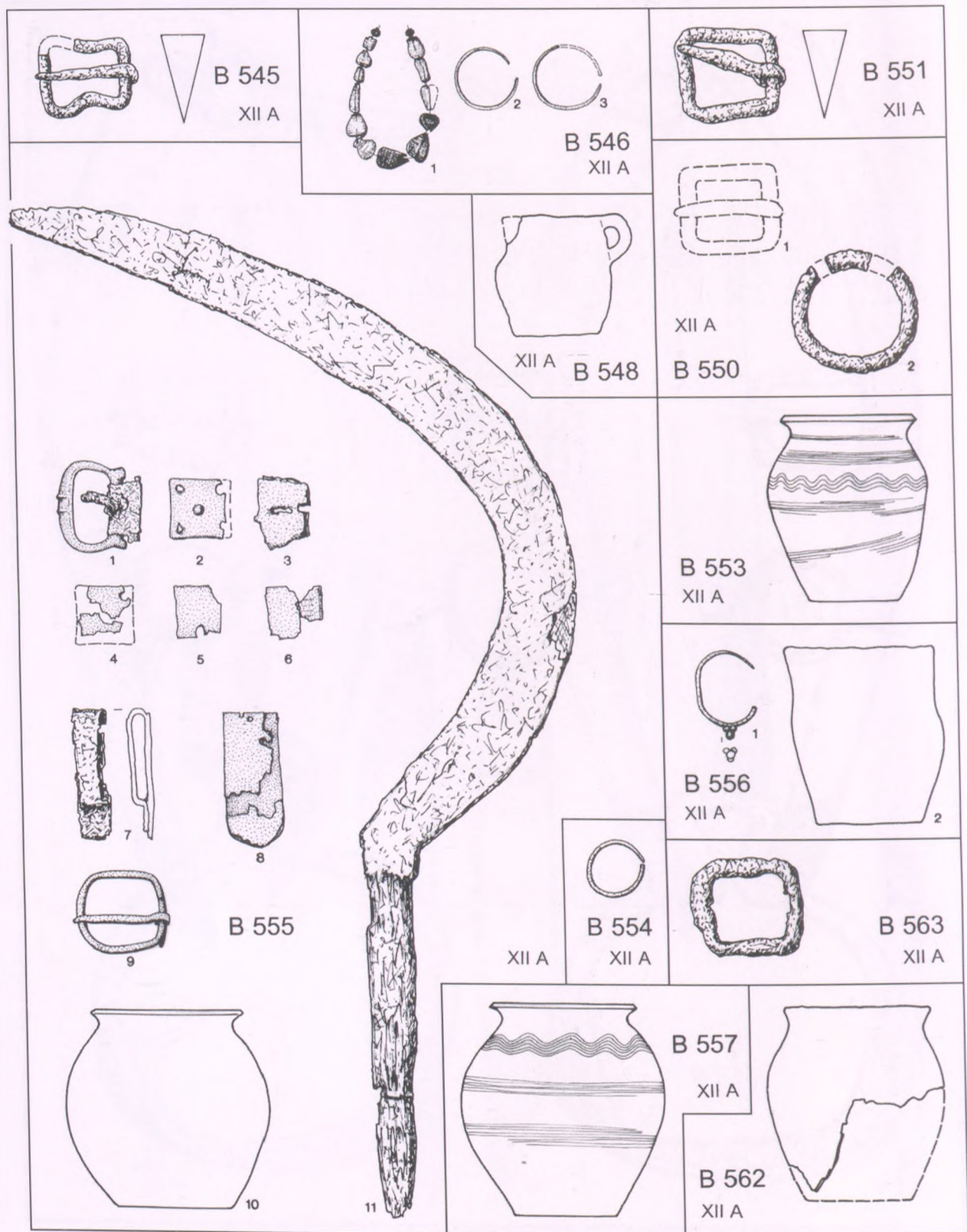

Taf. 92 Gräber 545, 546, 548, 550, 551, 553, 554, 555, 556, 557, 562, 563

KÖLKED – FEKETEKAPO B

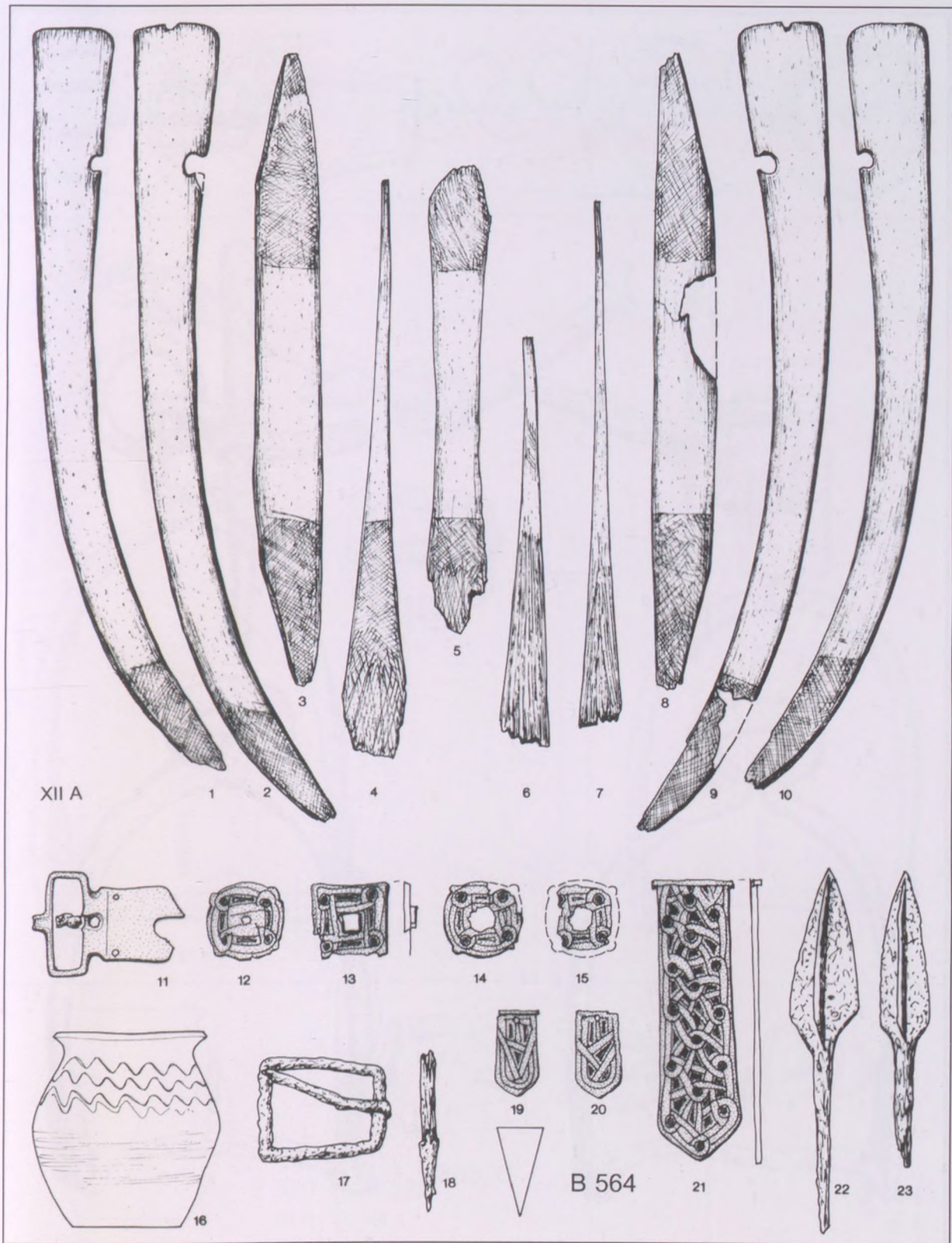

Taf. 93 Grab 564

KÖLKED – FEKETE KAPU B

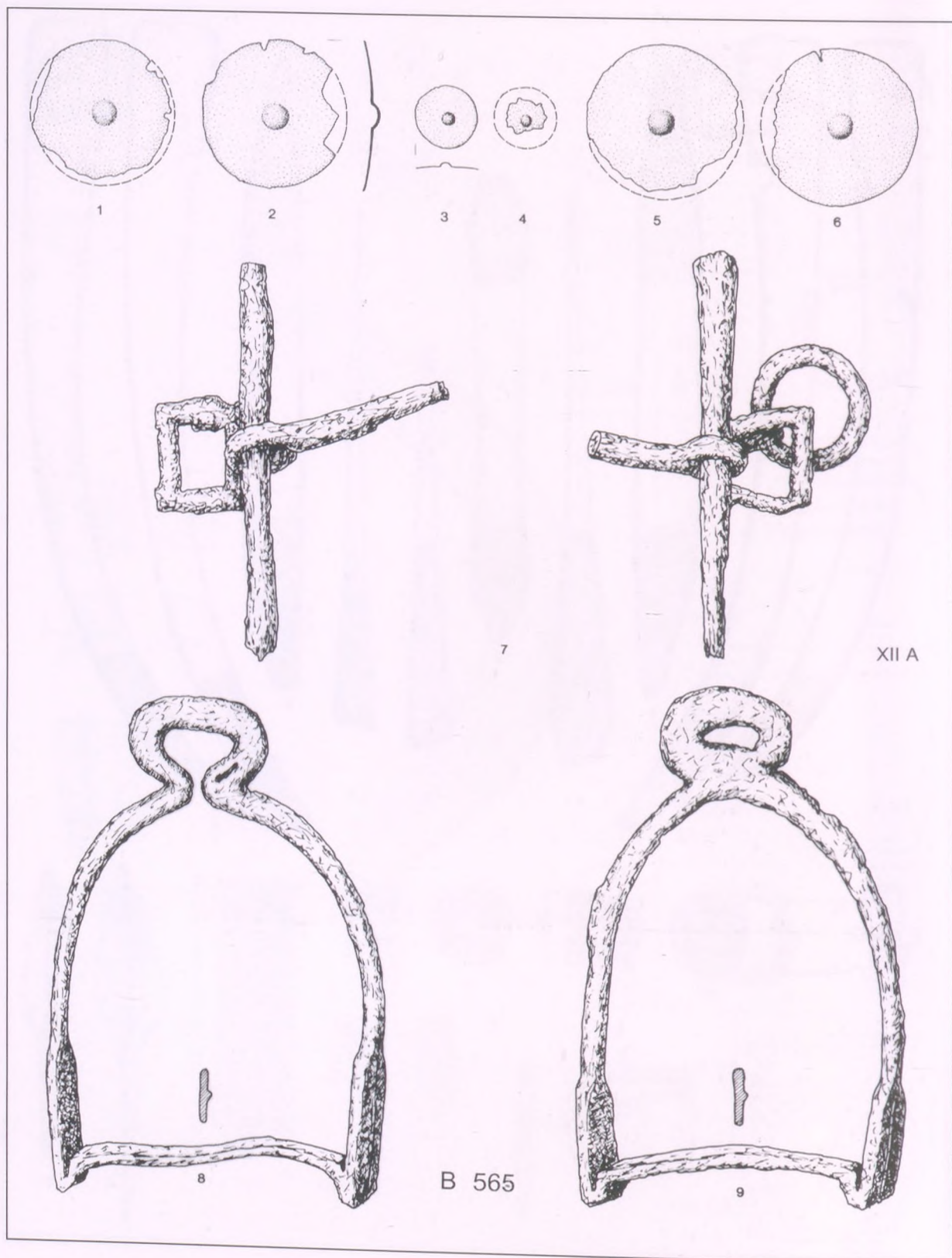

Taf. 94 Grab 565

KÖLKED – FEKETEKAPOU B

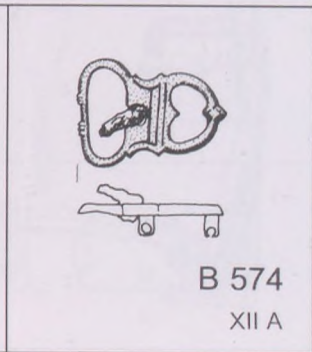
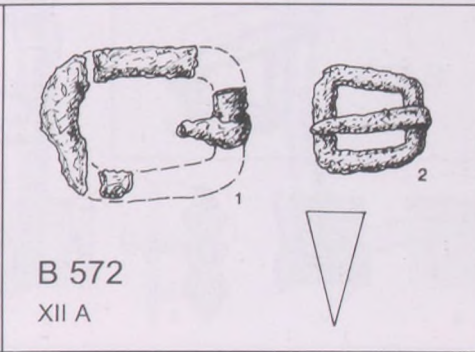
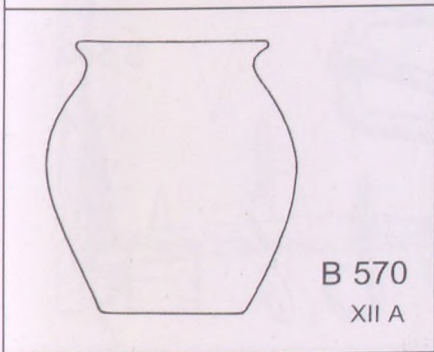
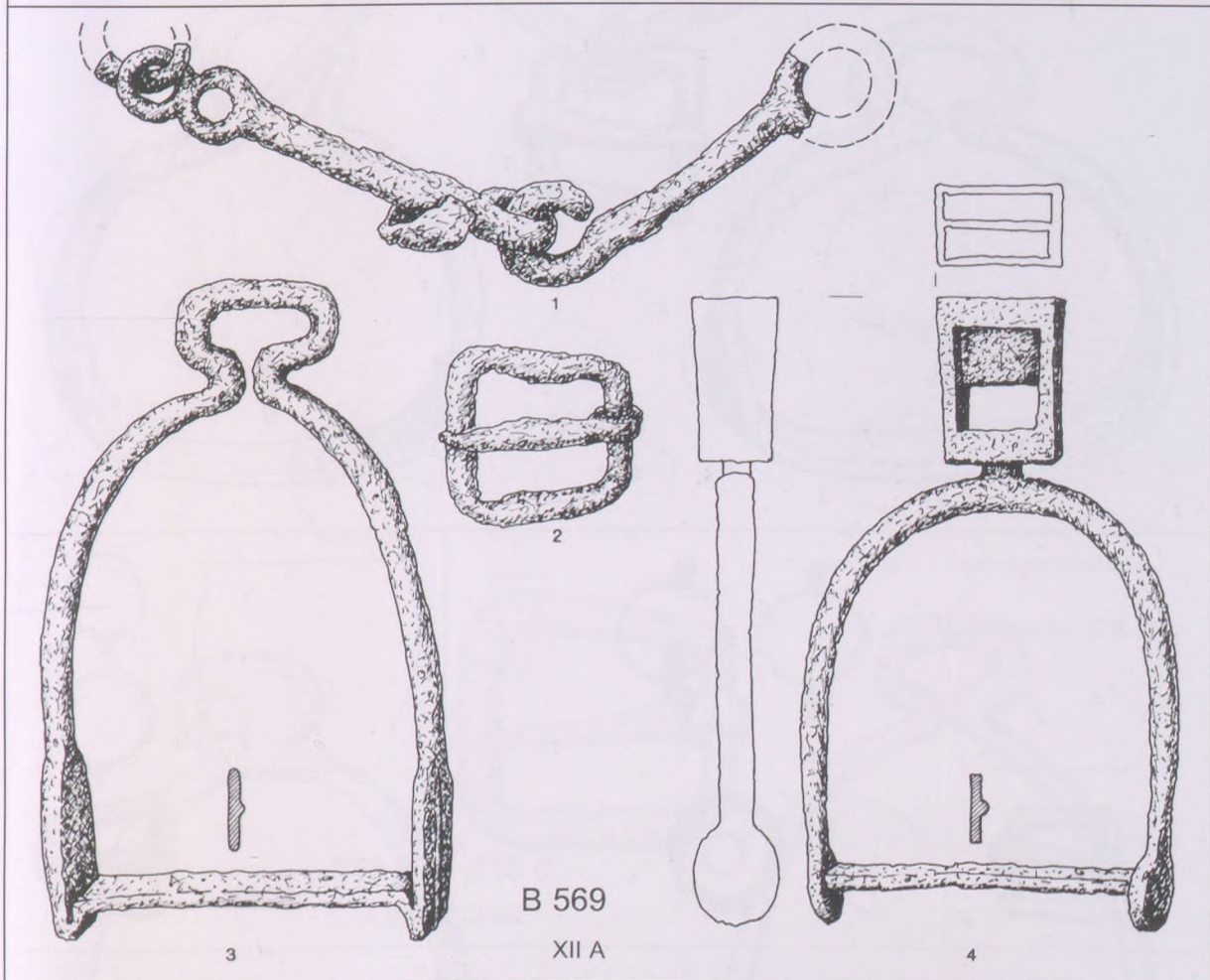
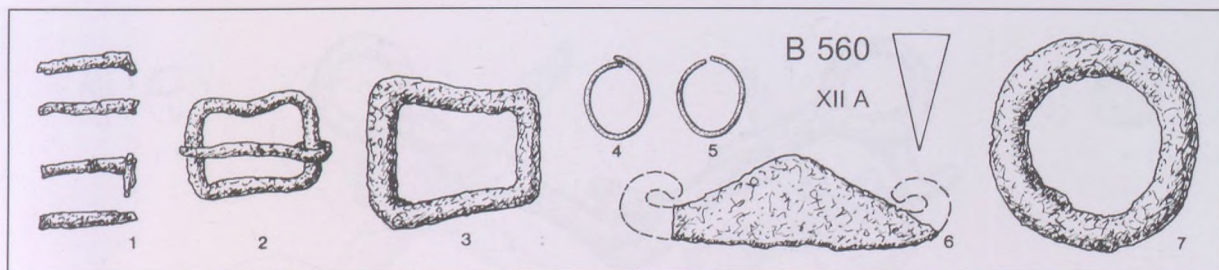

Taf. 95 Gräber 560, 569, 570, 572, 574

KÖLKED – FEKETEKAPO B

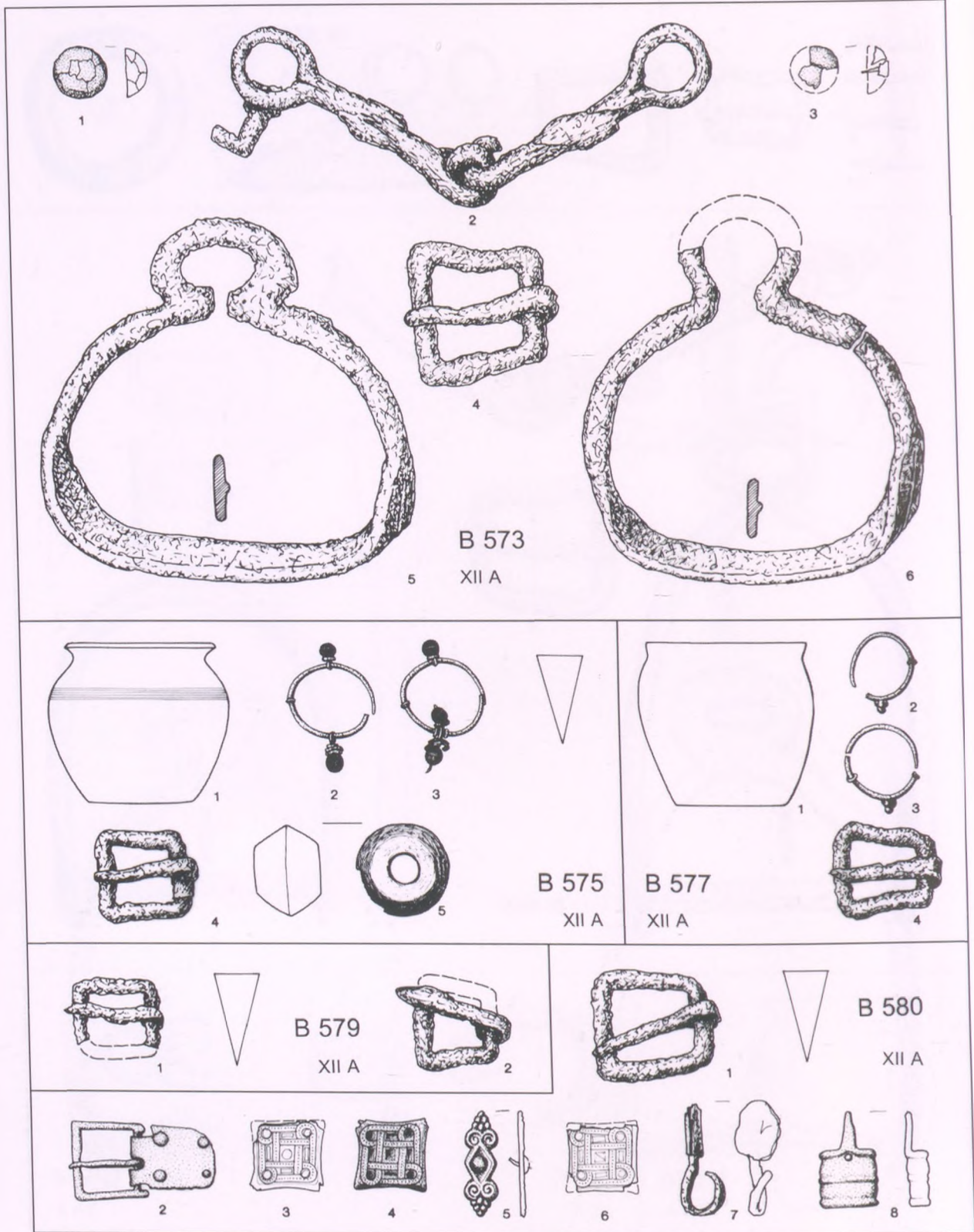

Taf. 96 Gräber 573, 575, 577, 579, 580

KÖLKED – FEKETE KAPU B

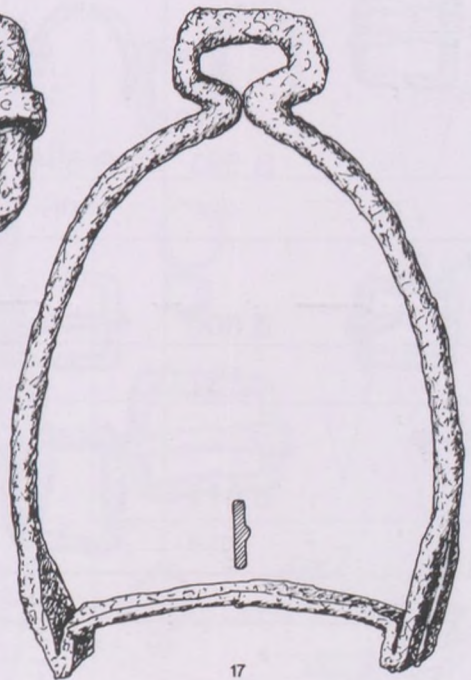
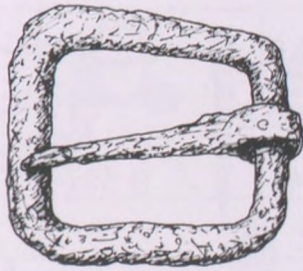
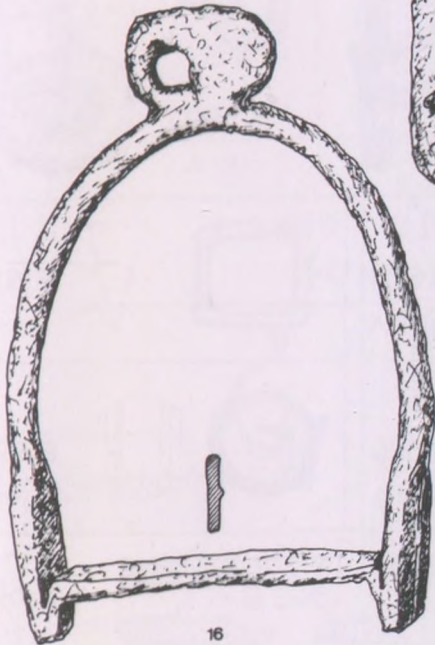
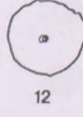
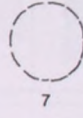
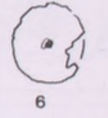
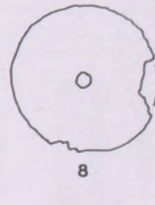
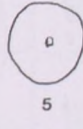
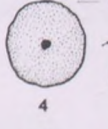
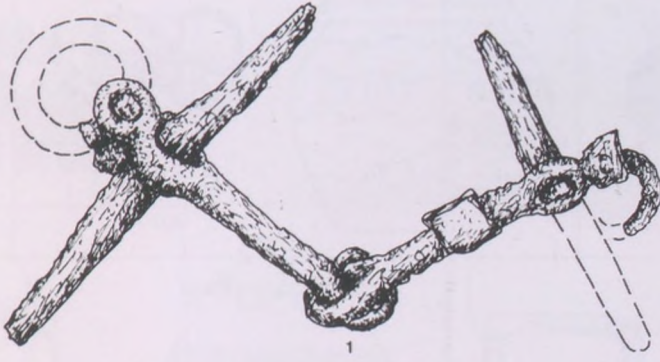

B 581

XII A

Taf. 97 Grab 581

KÖLKED – FEKETEKAJU B

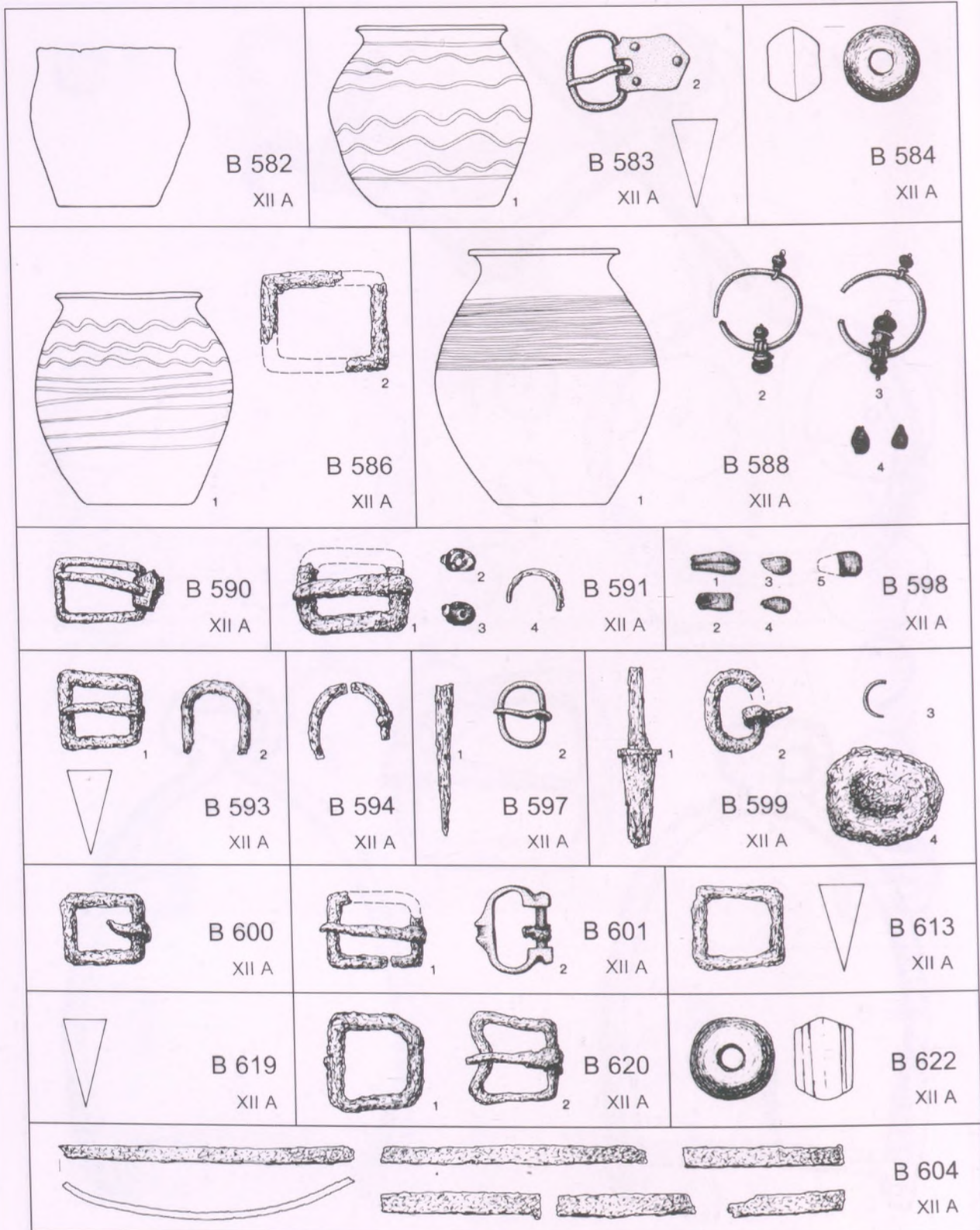

Taf. 98 Gräber 582, 583, 584, 586, 588, 590, 591, 593, 594, 597, 598, 599, 600, 601, 604, 613, 620, 622

KÖLKED – FEKETEKAPO B

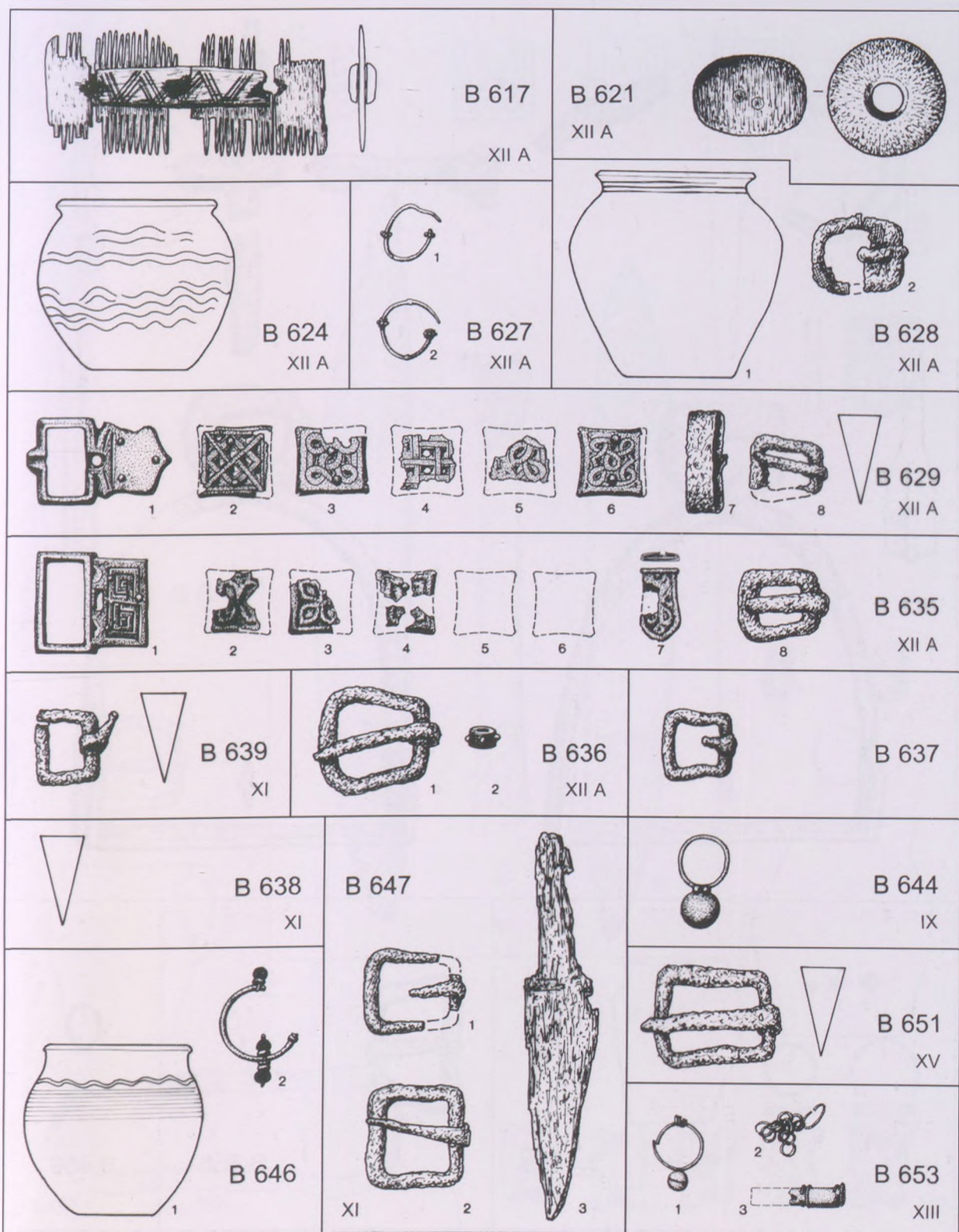

Taf. 99 Gräber 617, 621, 624, 627, 628, 629, 635, 636, 637, 638, 639, 644, 646, 647, 651, 653

KÖLKED – FEKETEKAJU B

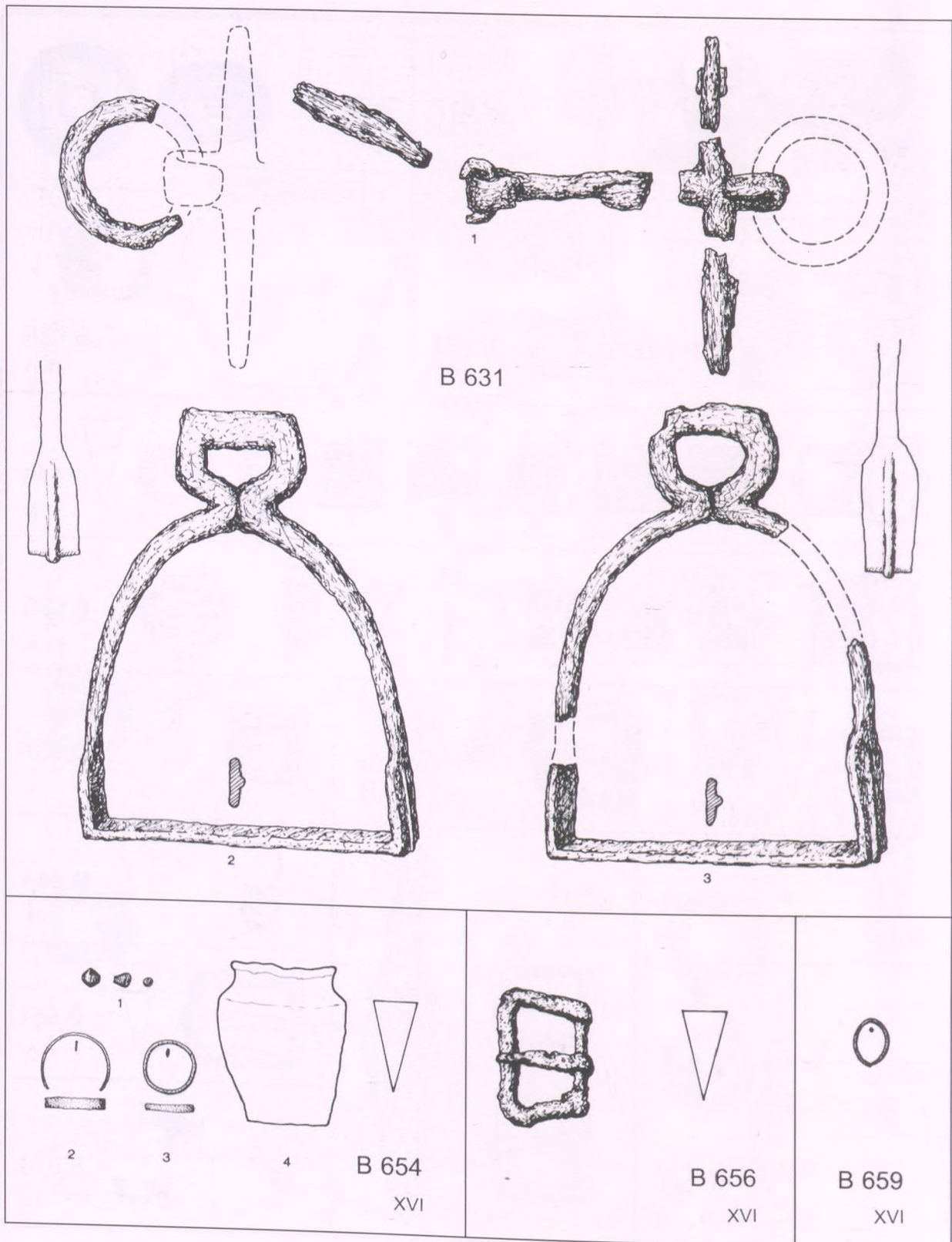

Taf. 100 Grab 631, 654, 656, 659

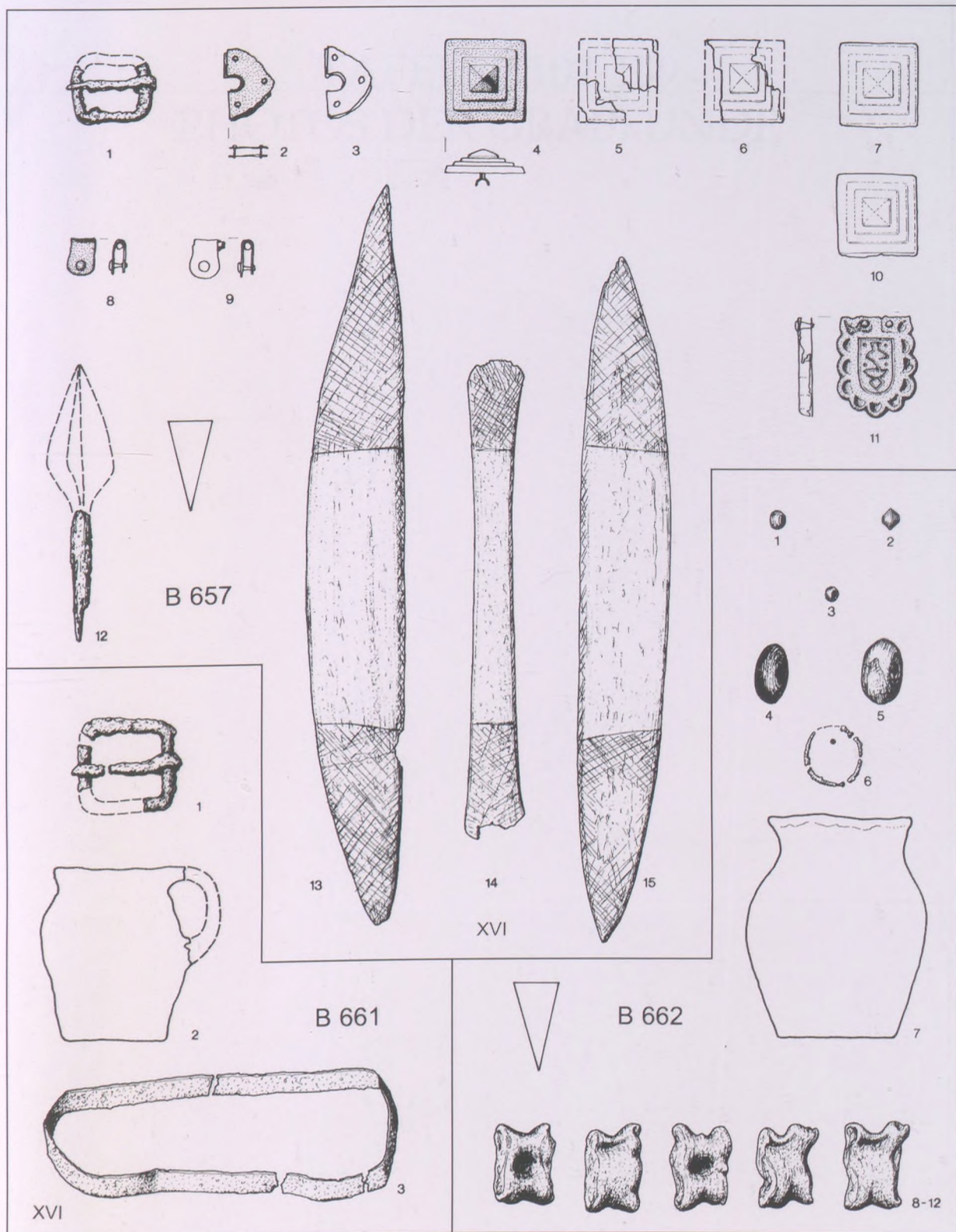

Taf. 101 Gräber 657, 661, 662

TAFELN 102-159

PHOTOS DER GRABFUNDE



1

2

Taf. 102 1-2: Grab 80

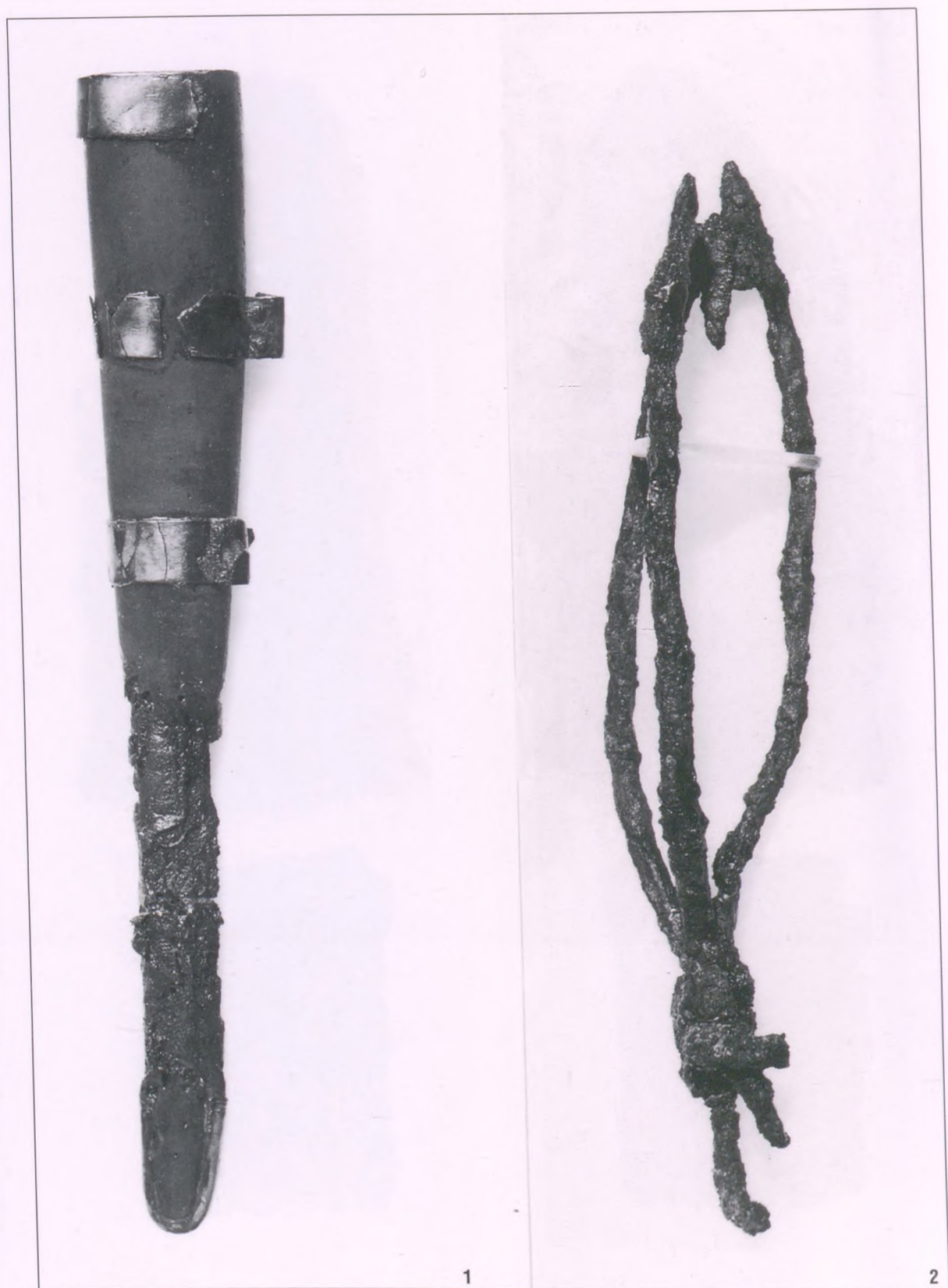

1

2

Taf. 103 1: Grab 85; 2: Grab 80

KÖLKED – FEKETEKAPU B



Taf. 104 1-8: Grab 85



1



2



3



4



5



6



7



8

Taf. 105 1-8: Grab 85



1



2



3

Taf. 106 1-3: Grab 85

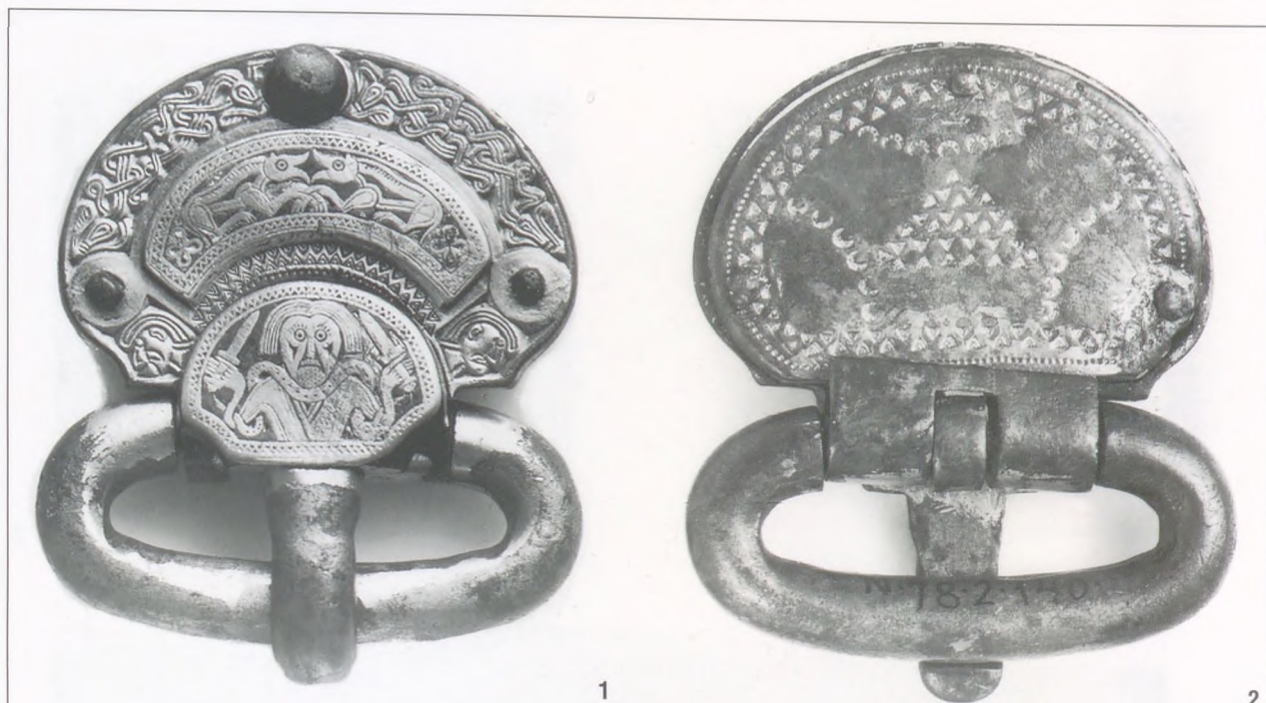

Taf. 107 1-3: Grab 85



1



2



3

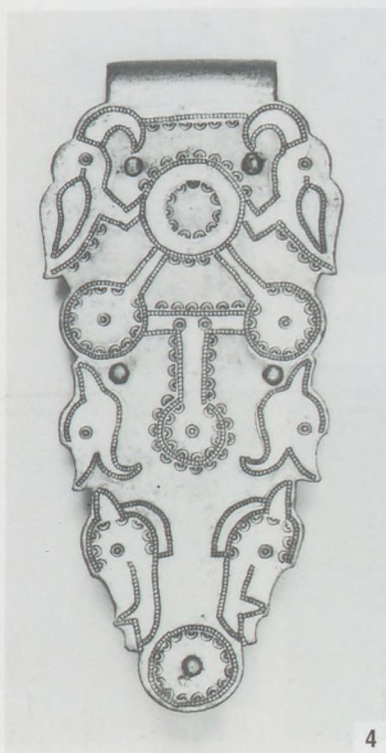

4



5

Taf. 108 1-3: Grab 85; 4-5: Grab 119



1



2



3



5



6



7



8



4

Taf. 109 1: Grab 89; 2: Grab 100; 3-4: Grab 88; 5-8: Grab 118

KÖLKED – FEKETEKAPO B



1a

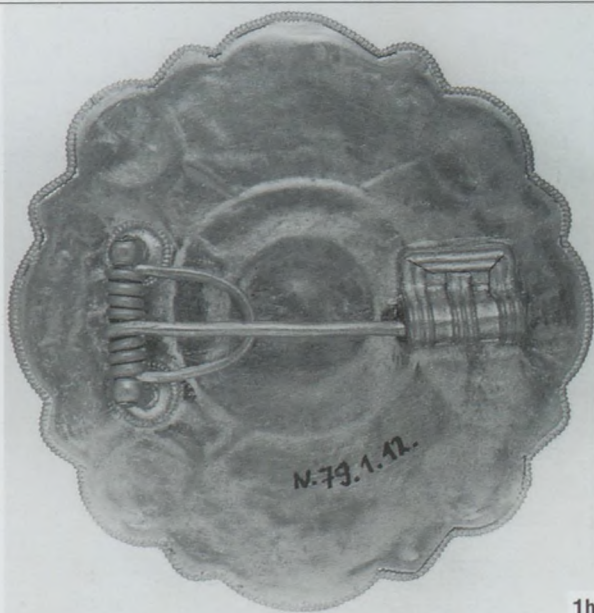

1b



2



4



3



5

Taf. 110 1-5: Grab 119

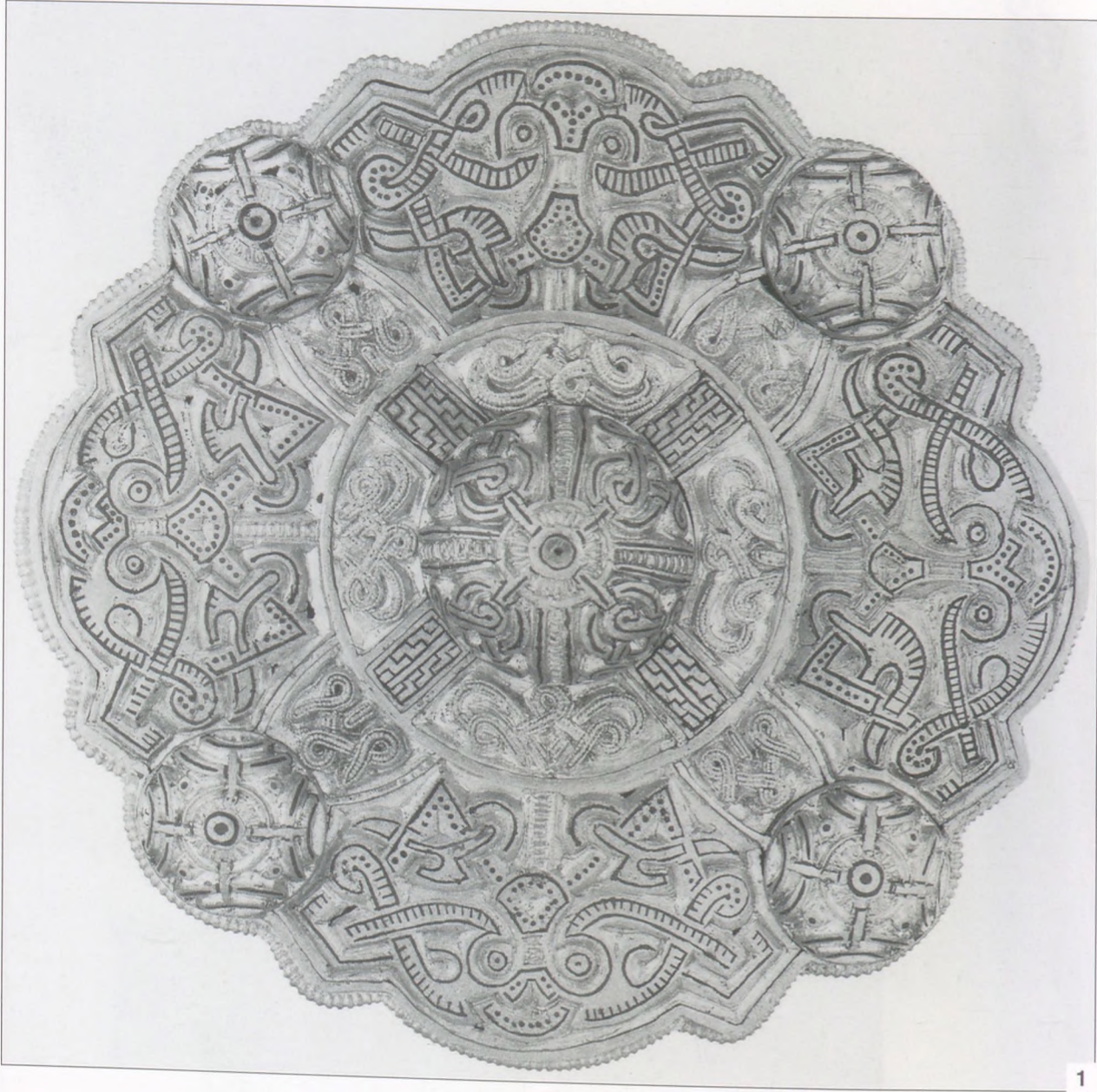

Taf. 110a 1: Grab 119

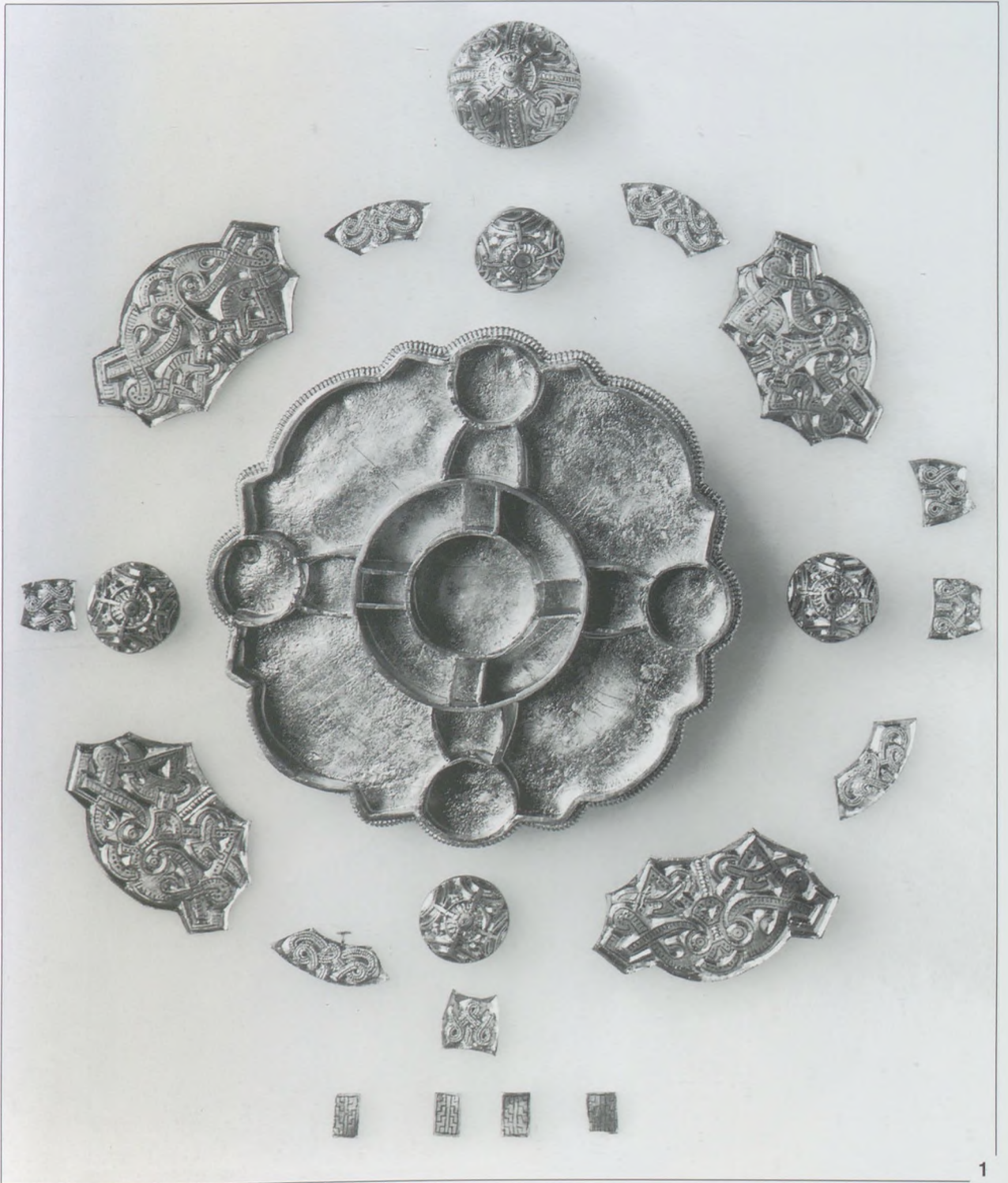

Taf. 111 1: Grab 119



Taf. 112 1: Grab 119

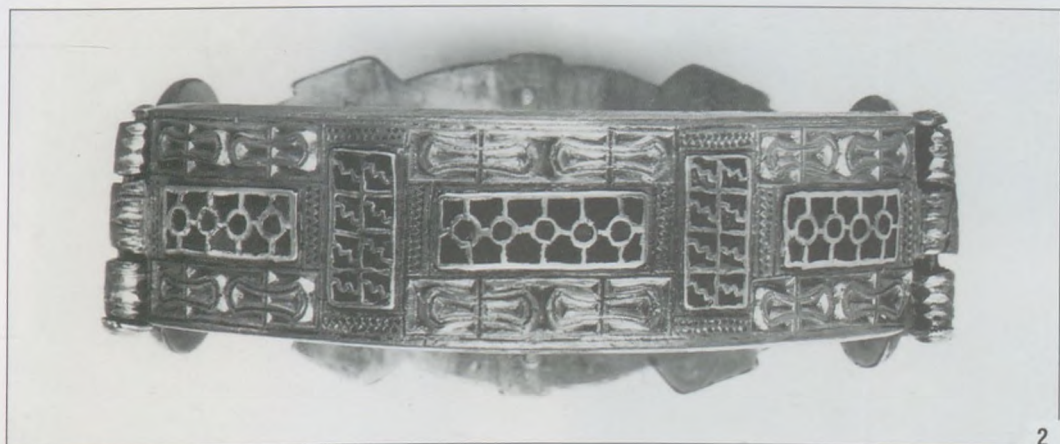
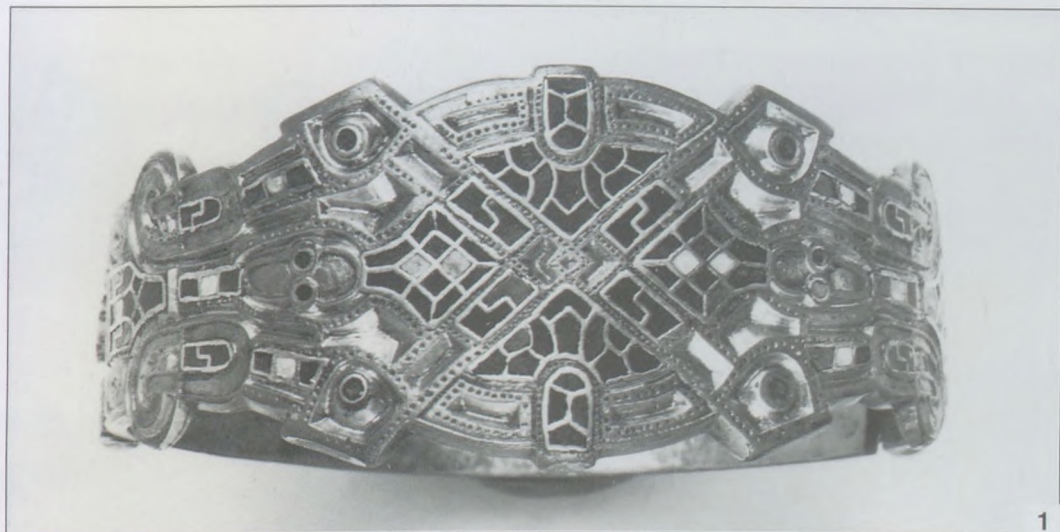

Taf. 113 1-3: Grab 119



1



2a

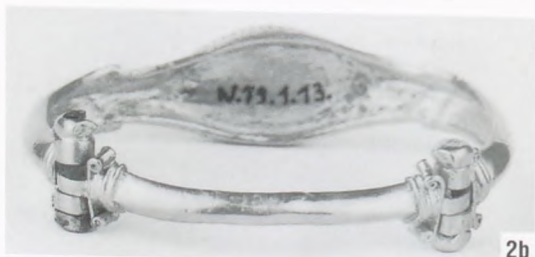

2b



3



4

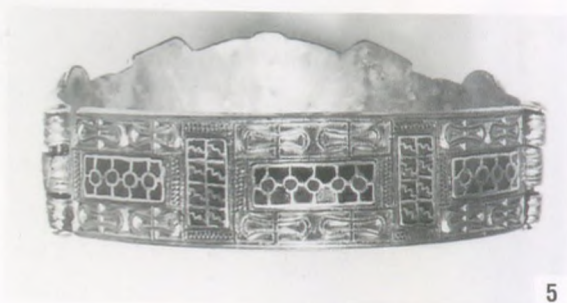

5



6



7



8

Taf. 114 1-8: Grab 119



1



2



3



7a



4



5



6a



6b



7b



8a



8b

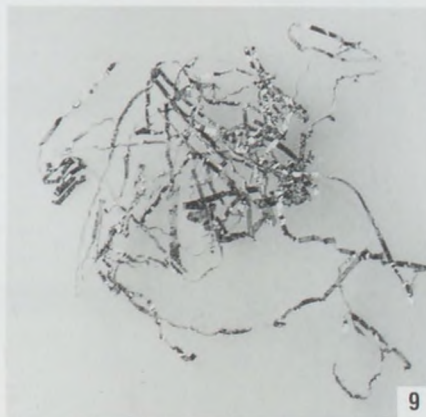

9

Taf. 115 1-9: Grab 119

KÖLKED – FEKETE KAPU B

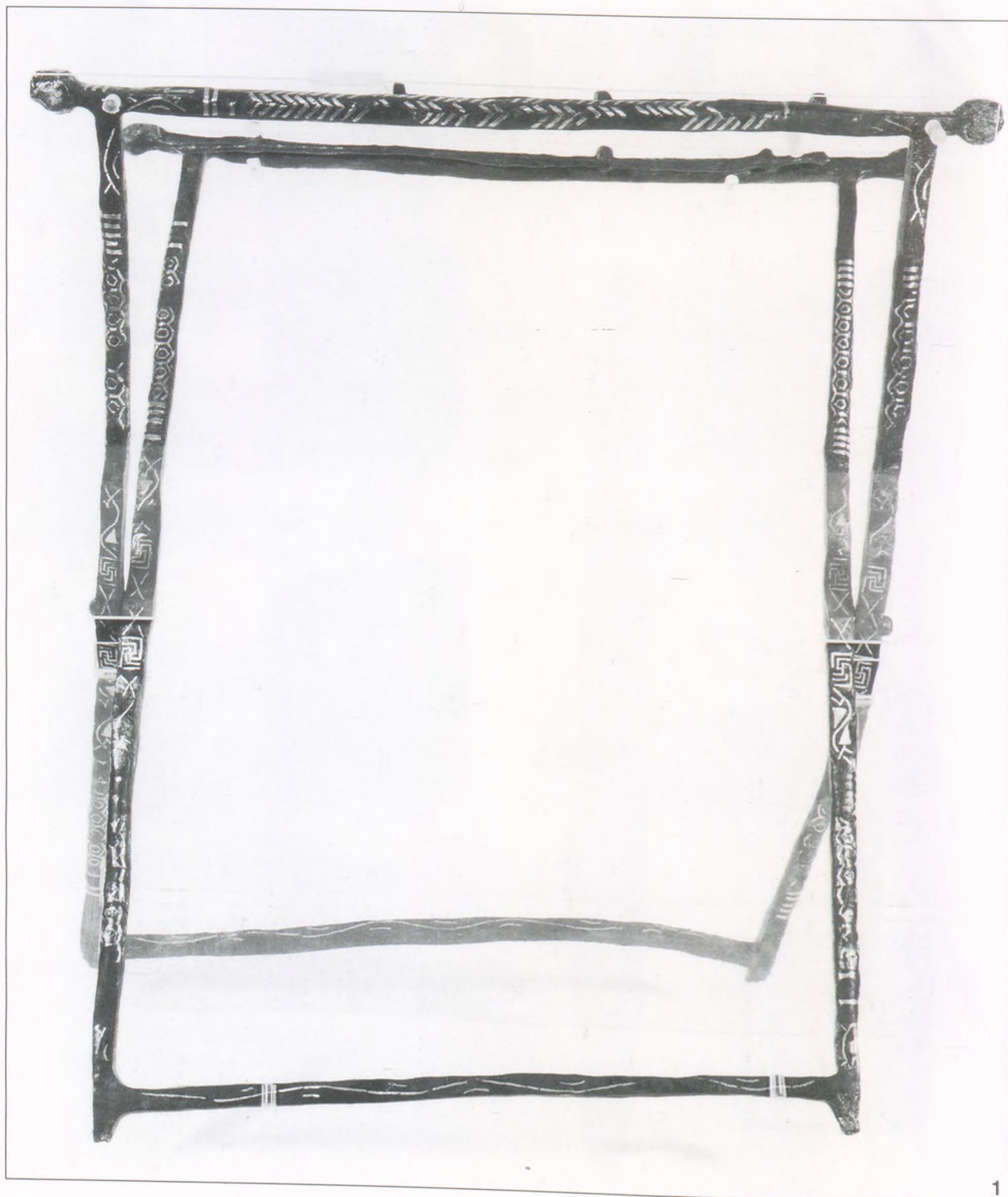

Taf. 116 1: Grab 119

KÖLKED – FEKETEKAJU B

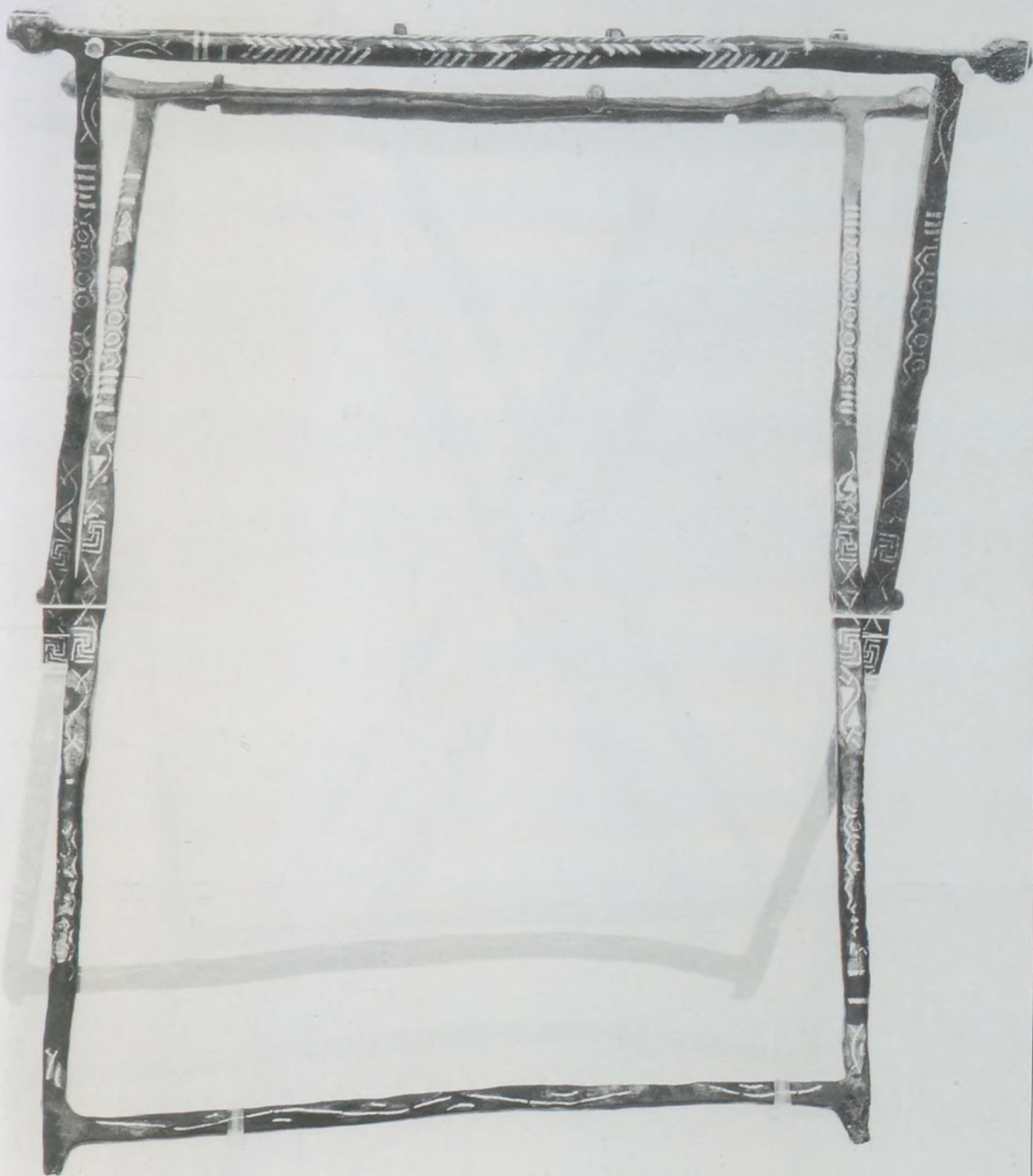

Taf. 117 1: Grab 119

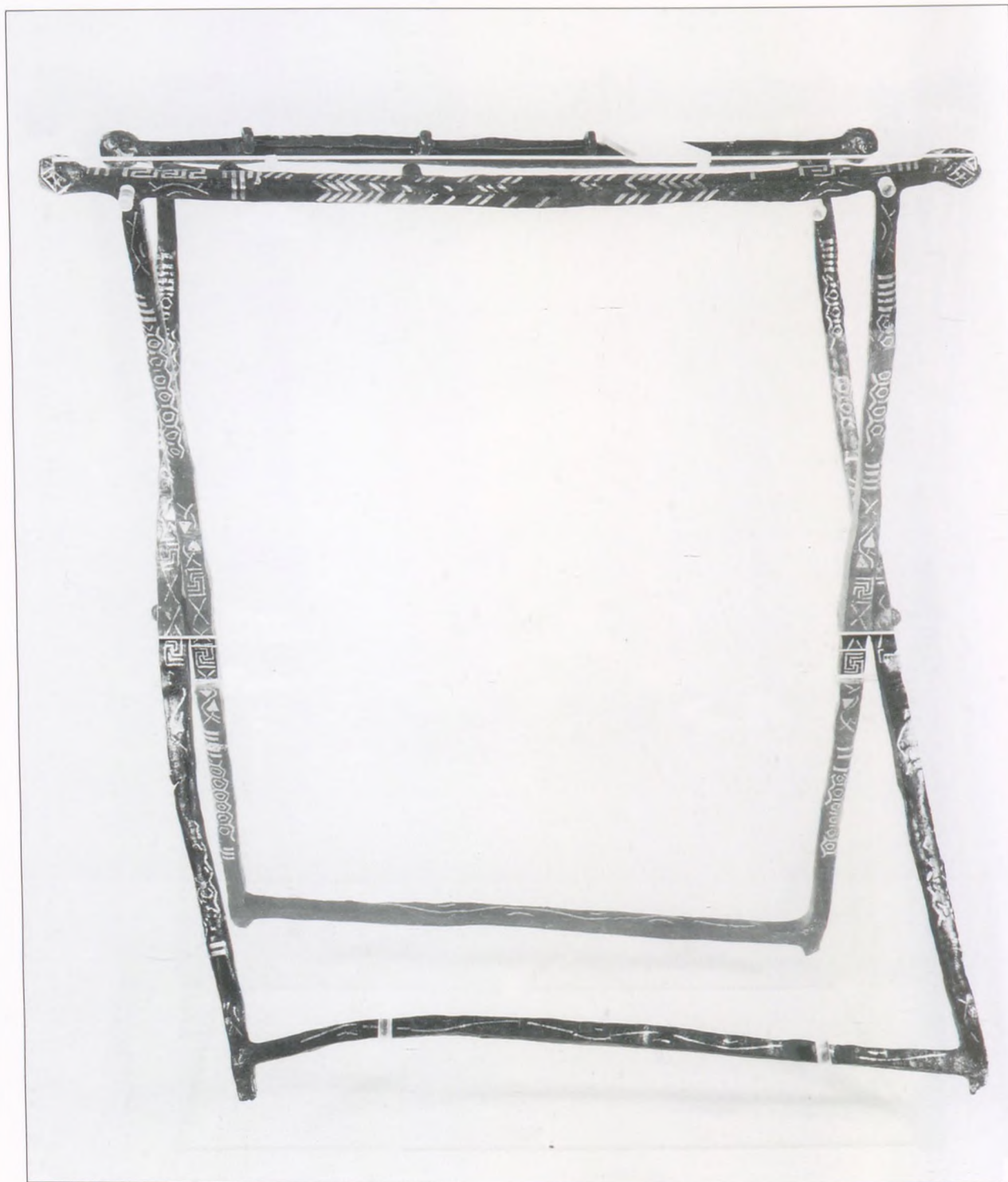

Taf. 118 1: Grab 119

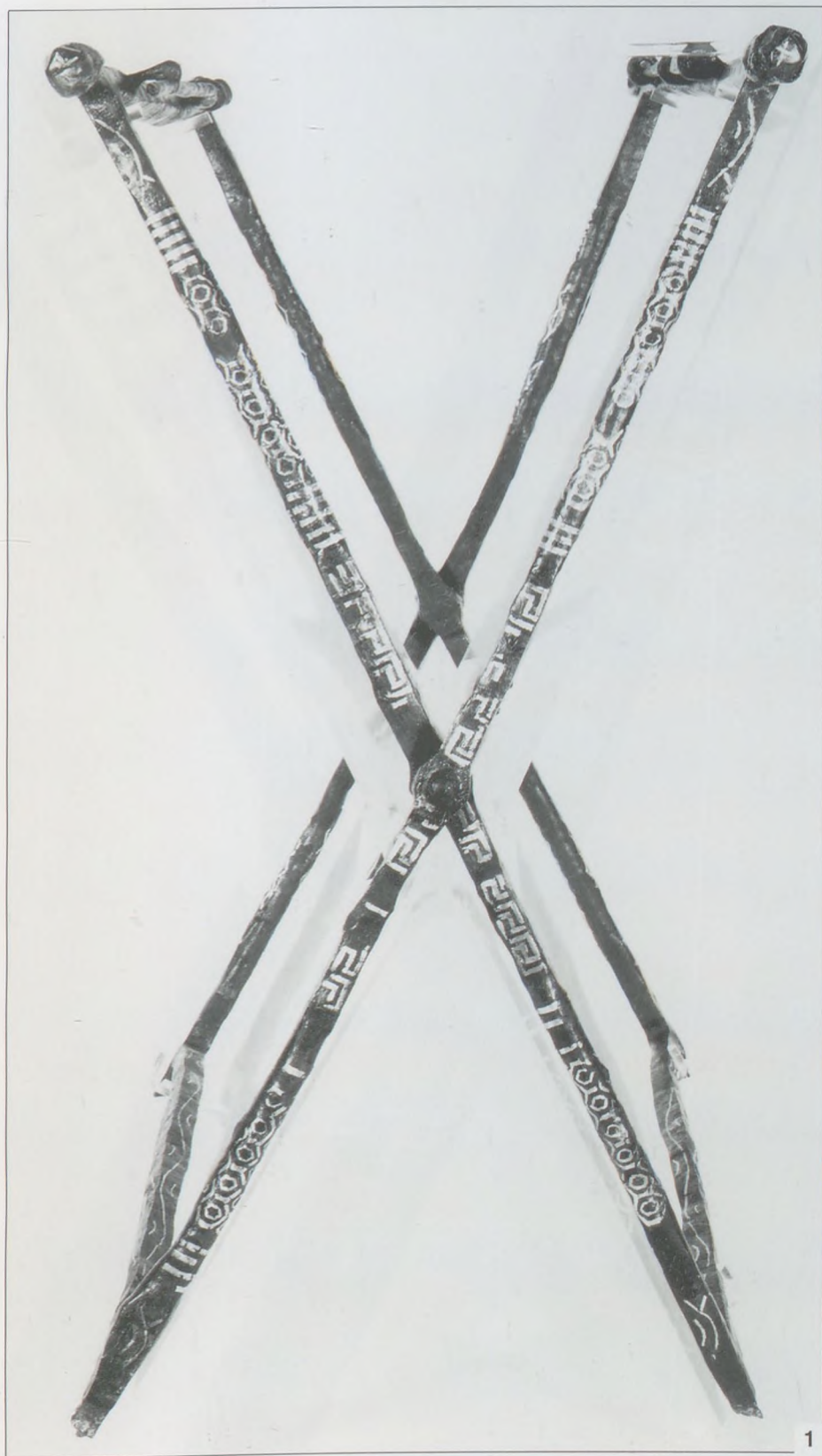

Taf. 119 1: Grab 119

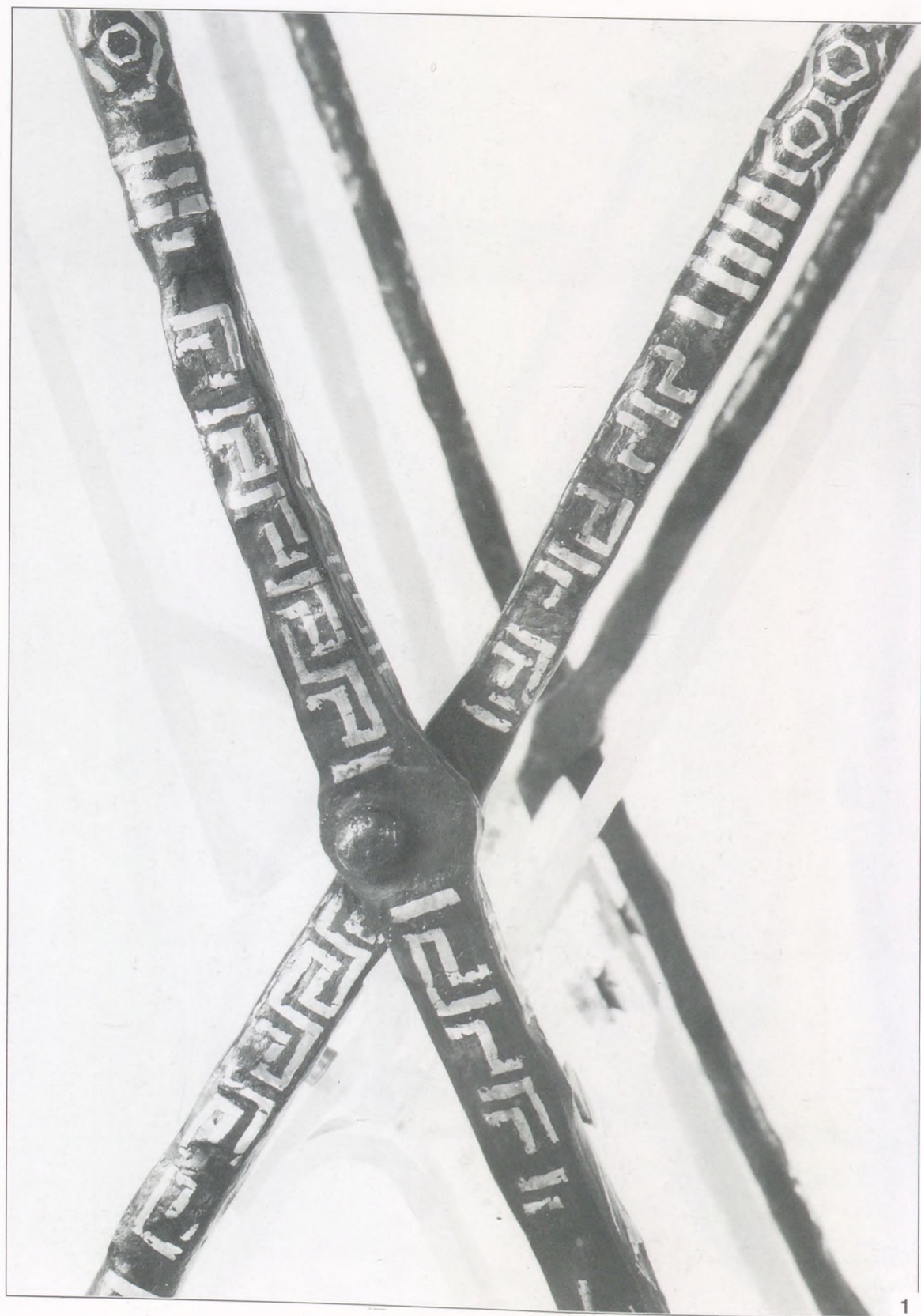

Taf. 120 1: Grab 119

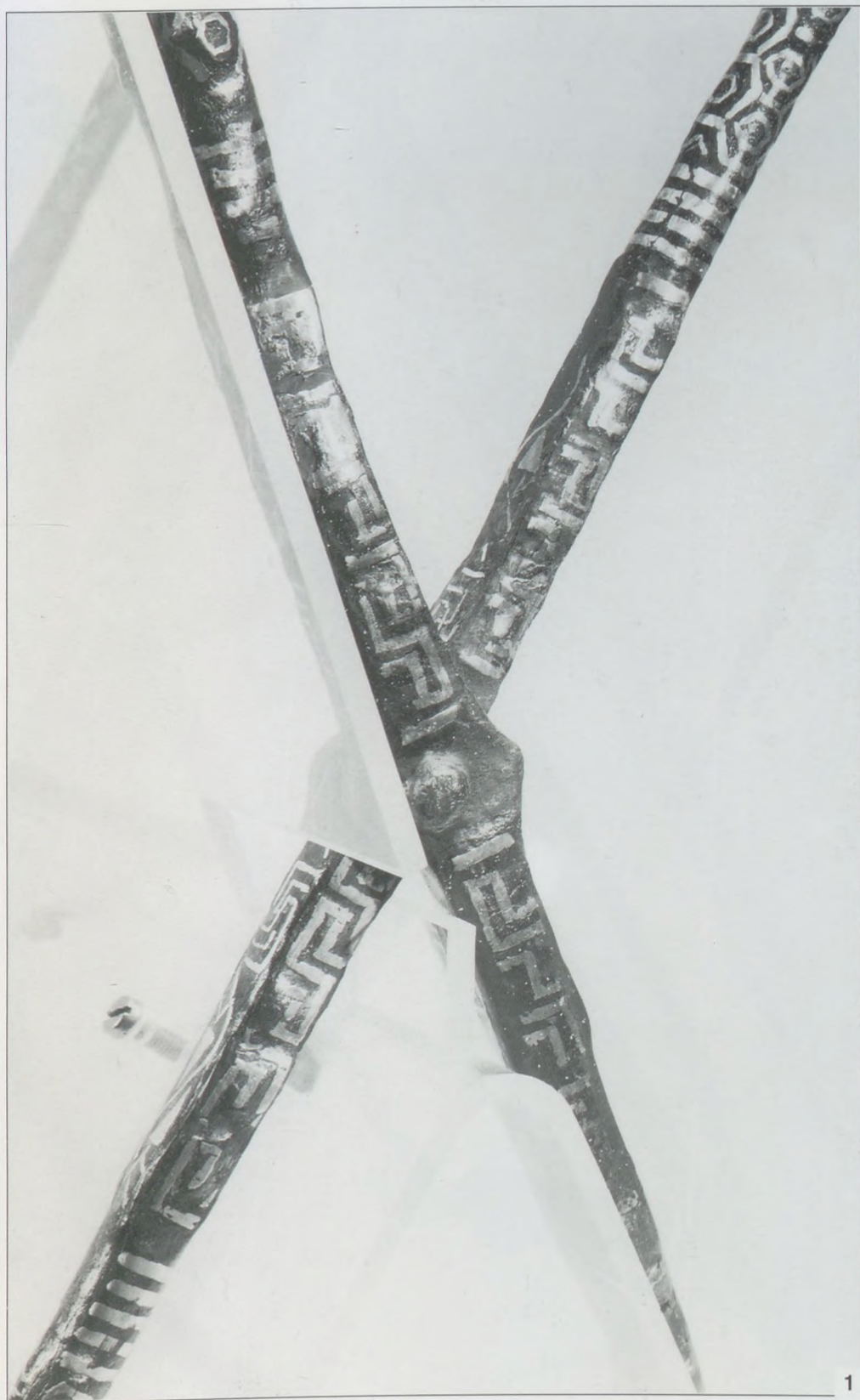

1

Taf. 121 1: Grab 119

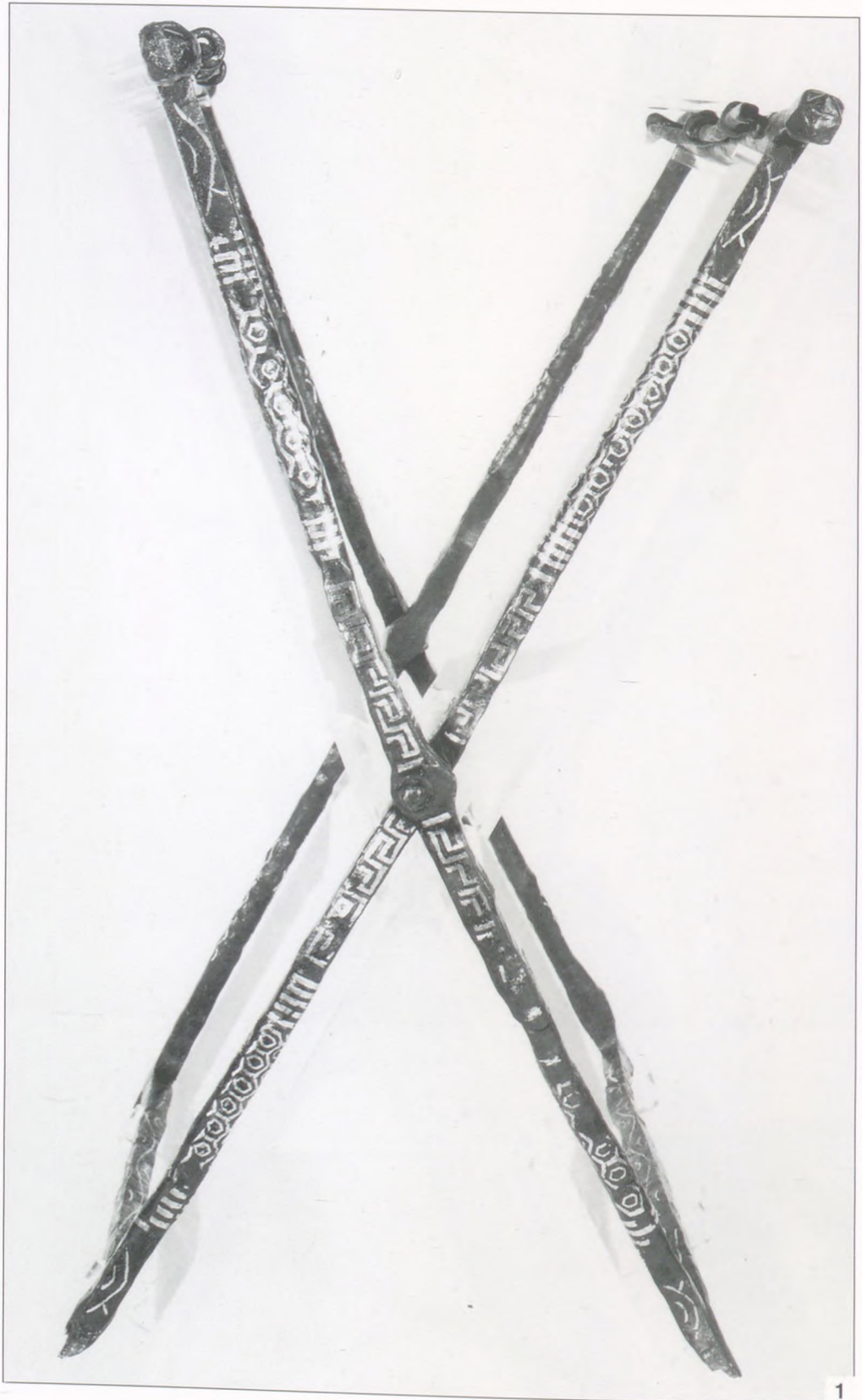

1

Taf. 122 1: Grab 119



1

Taf. 123 1: Grab 119



Taf. 124 1: Grab 119



Taf. 125 1-4: Grab 119



Taf. 126 1-3: Grab 119



1

2

3

Taf. 127 1-3: Grab 119

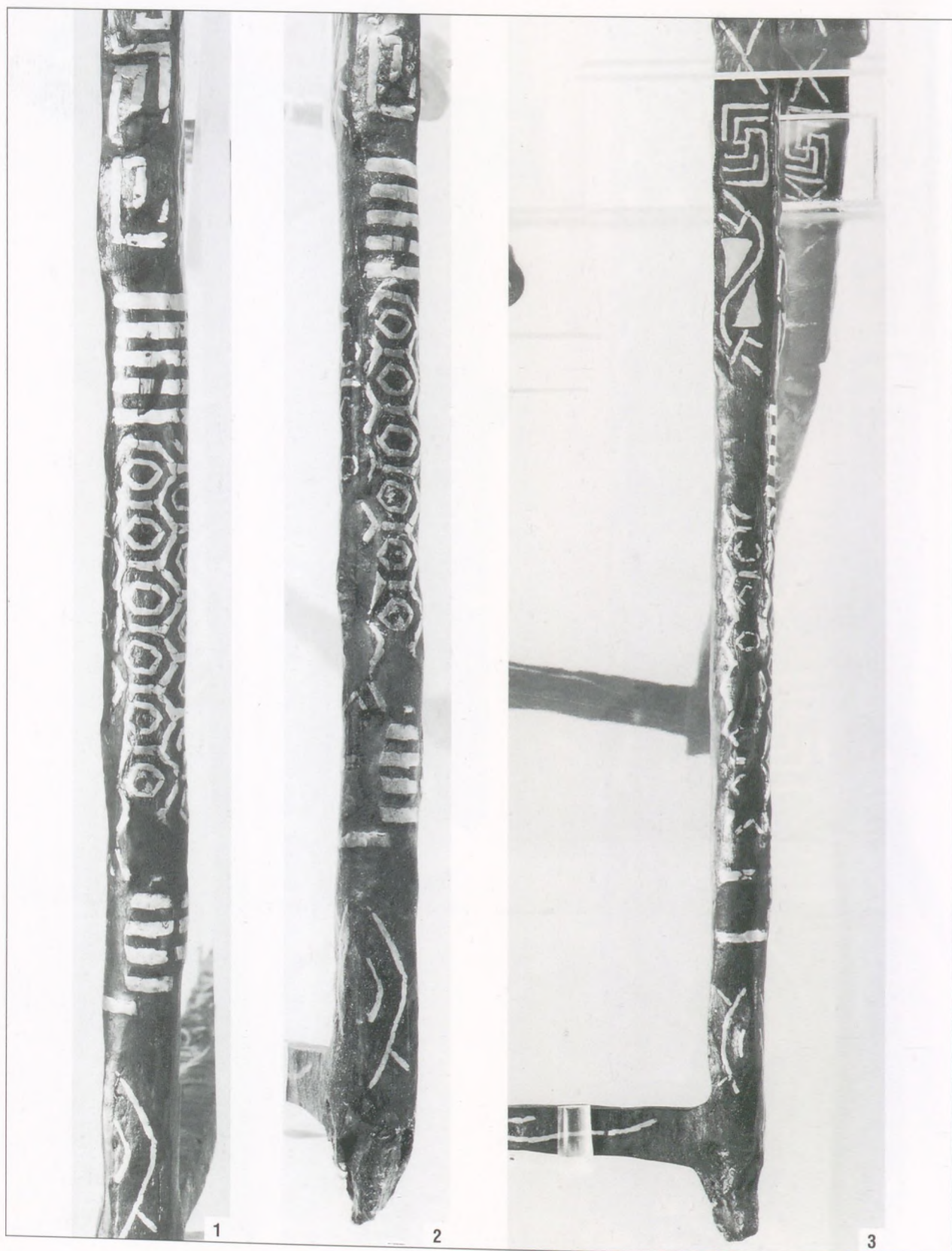

Taf. 128 1-3: Grab 119

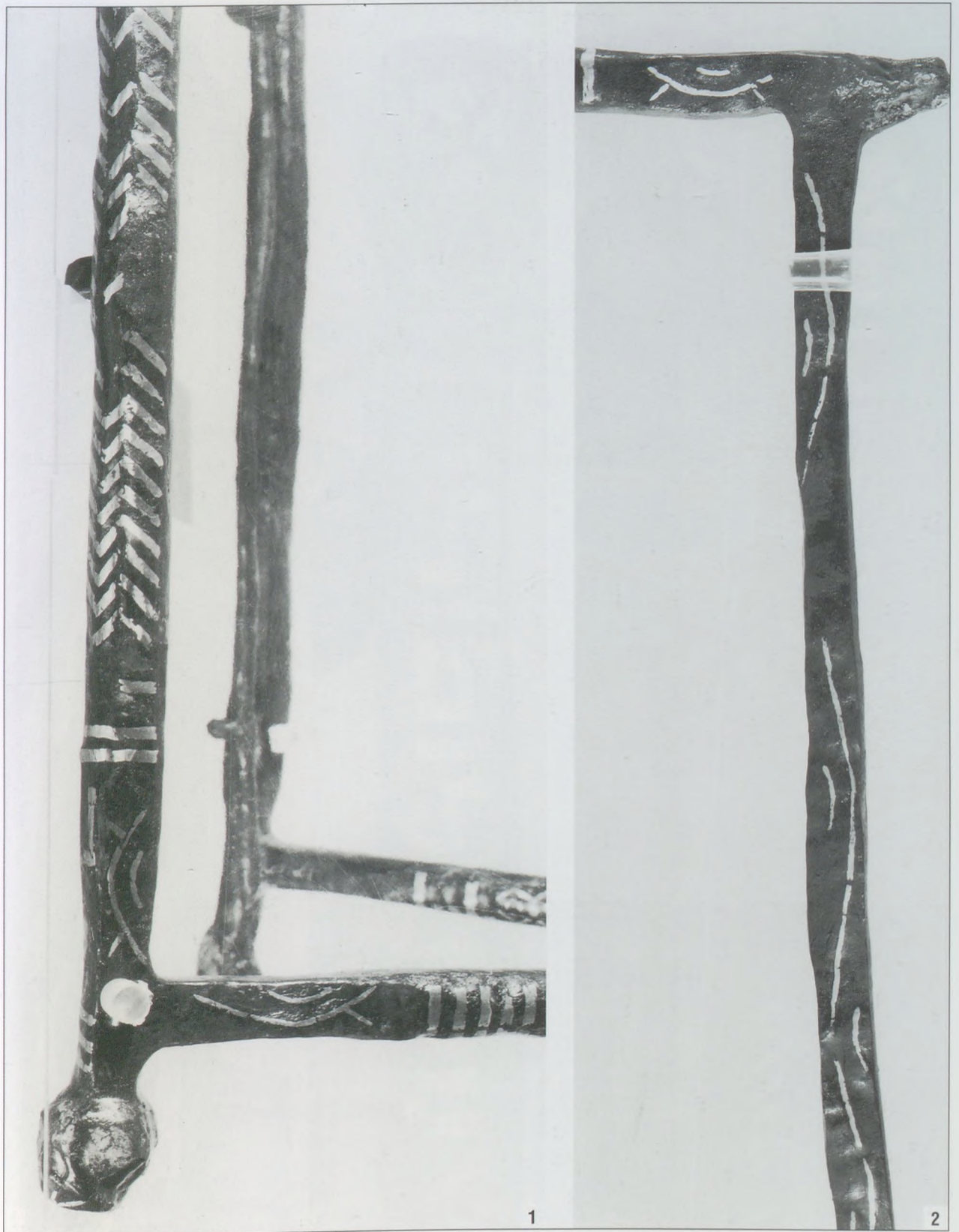

Taf. 129 1-2: Grab 119



Taf. 130 1-3: Grab 119

KÖLKED – FEKETE KAPU B



1



2

Taf. 131 1-2: Grab 119



Taf. 132 1-4: Grab 127



Taf. 133 1-3: Grab 173



1



2



3



4



5a



5b

Taf. 134 1-5: Grab 173

KÖLKED – FEKETEKAPU B



Taf. 135 1-2: Grab 173

KÖLKED – FEKETE KAPU B



Taf. 136 1: Grab 193; 2-7: Grab 207; 8-12: Grab 210

KÖLKED – FEKETEKAPU B

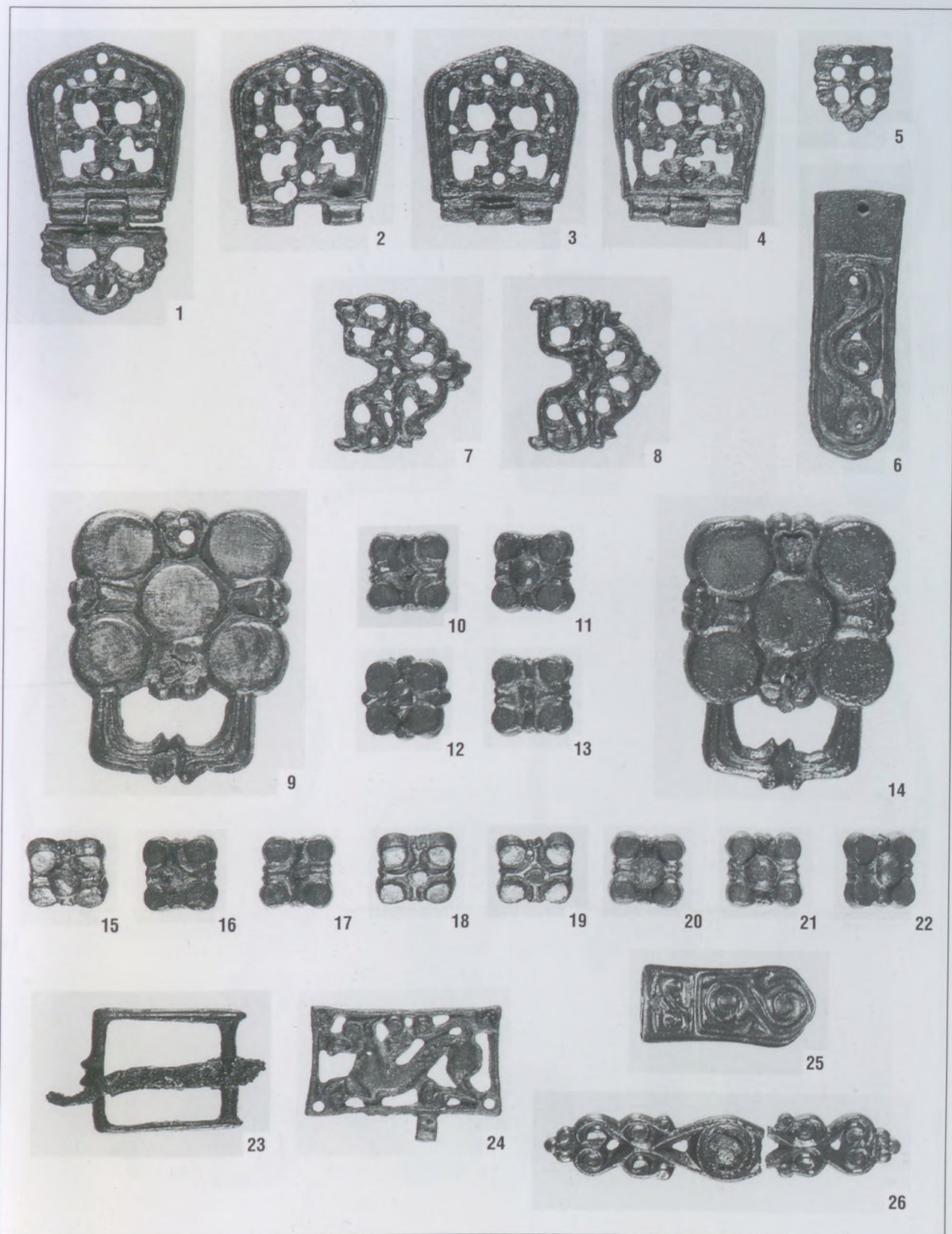

Taf. 137 1-8: Grab 199; 9-22: Grab 200; 23-26: Grab 219

KÖLKED – FEKETEKAPU B

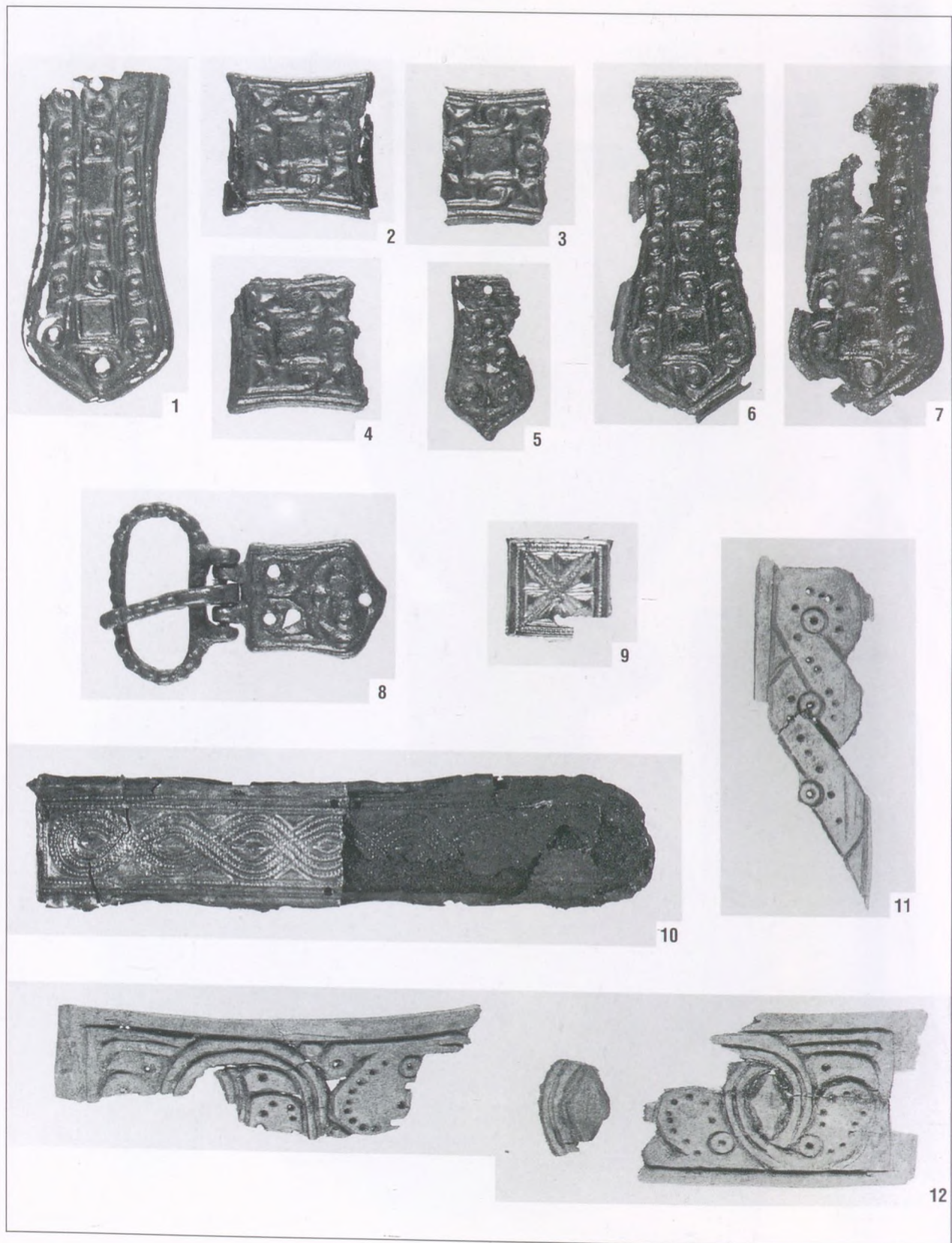

Taf. 136 1: Grab 193; 2-7: Grab 207; 8-12: Grab 210

KÖLKED – FEKETEKAPO B

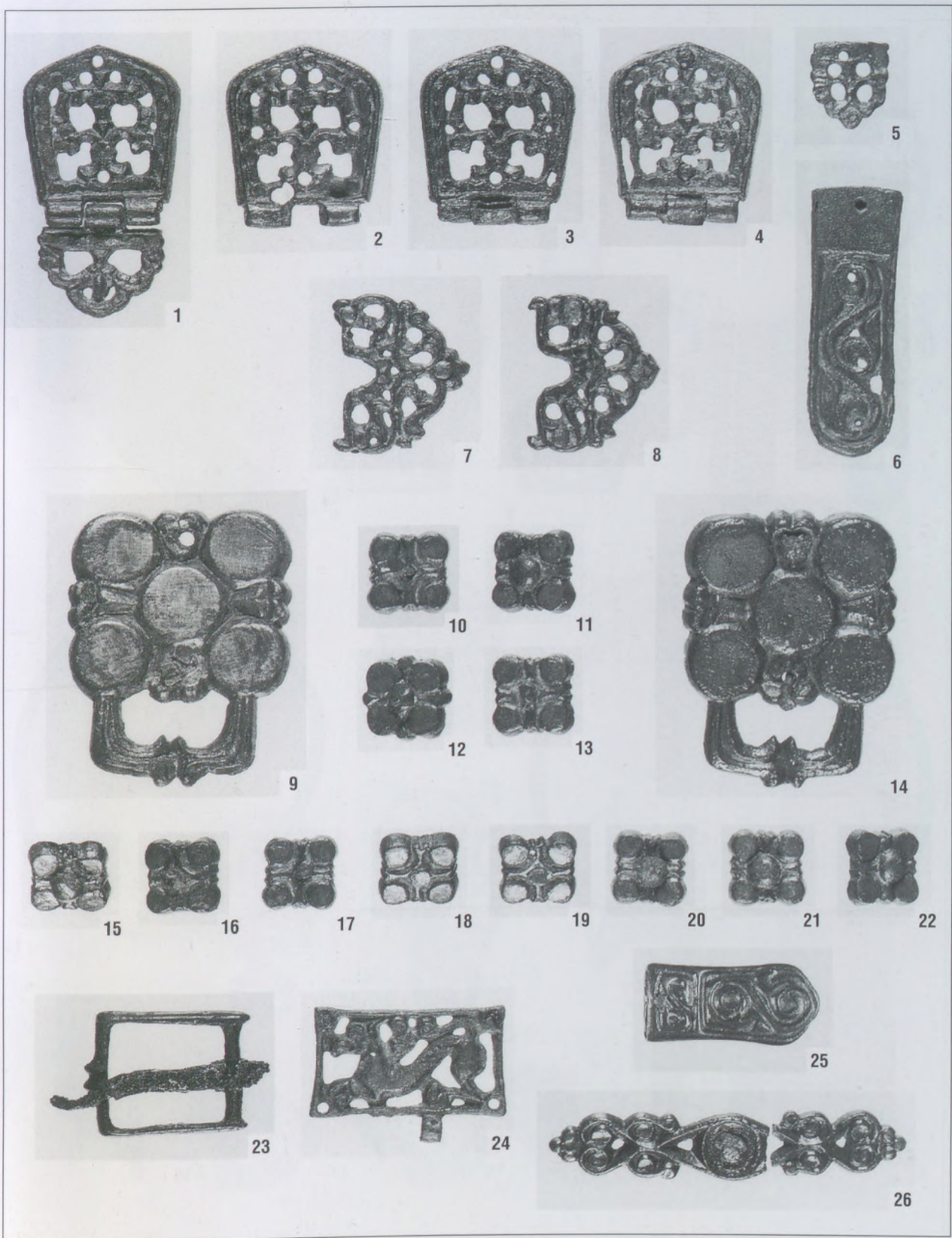

Taf. 137 1-8: Grab 199; 9-22: Grab 200; 23-26: Grab 219

KÖLKED – FEKETEKAJU B

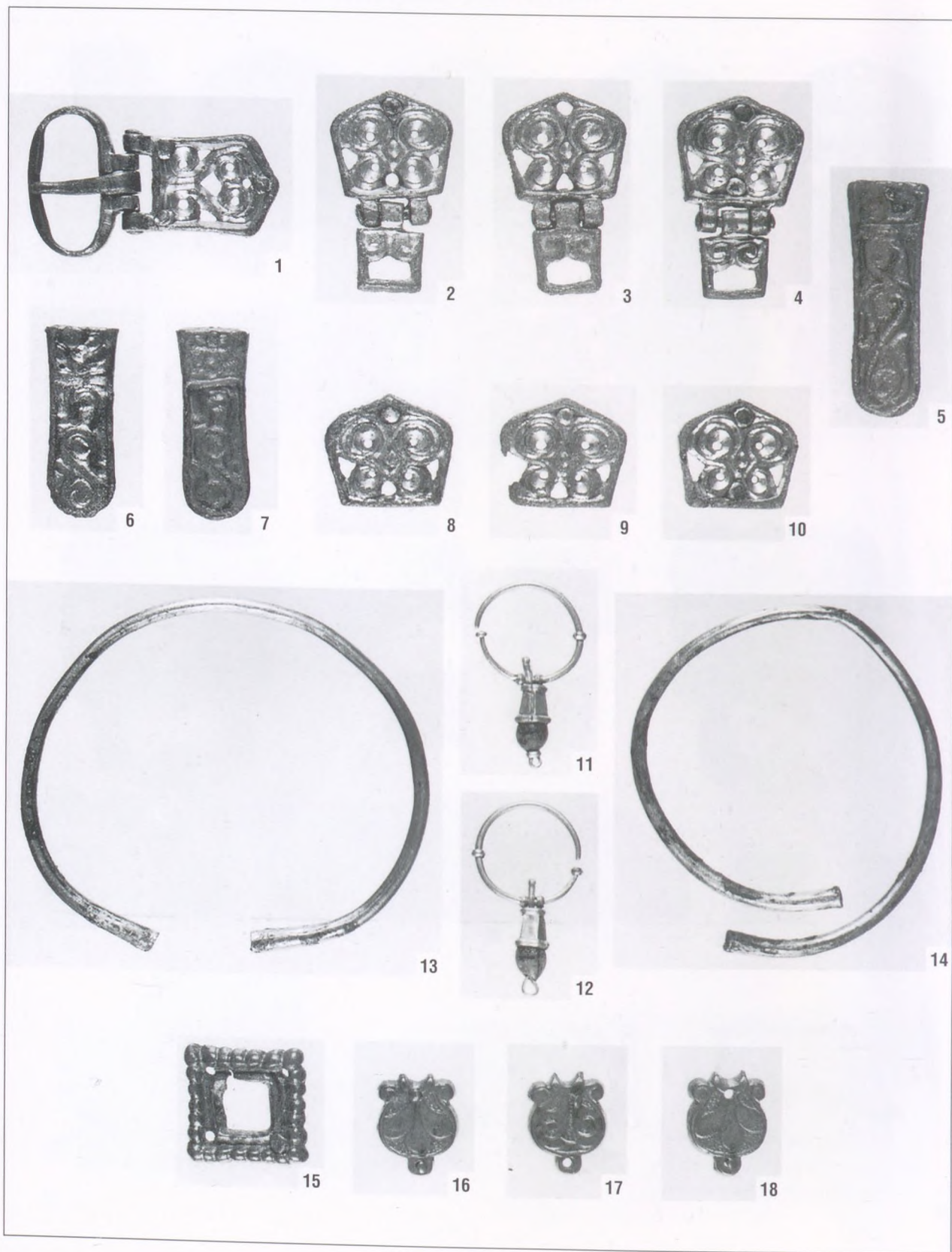

Taf. 138 1-10: Grab 201; 11-14: Grab 221; 15-18: Grab 250

KÖLKED – FEKETE KAPU B

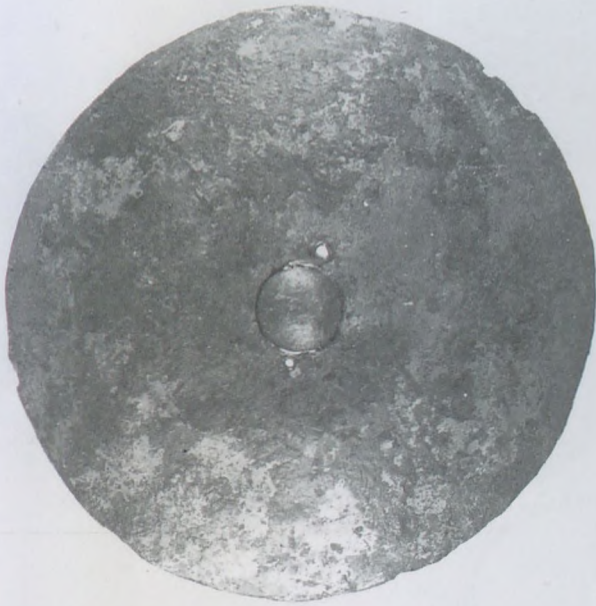

1



2

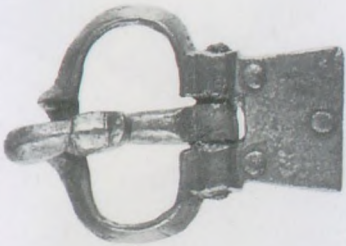

3



4



5



6



7



8



9



10



11



12



13

Taf. 139 1: Grab 220; 2: Grab 230; 3-13: Grab 236

KÖLKED – FEKETEKAJU B



1



2



3



4



9



5



6



7



8



10



11



12

Taf. 140 1-12: Grab 301

KÖLKED – FEKETEKAJU B



1



2



3



4



5



6



7



9



11



13



8



10



12



14

Taf. 141 1-2: Grab 303; 3: Grab 344; 4-5: Grab 339; 6: Grab 345; 7-14: Grab 343

KÖLKED – FEKETEKAPO B

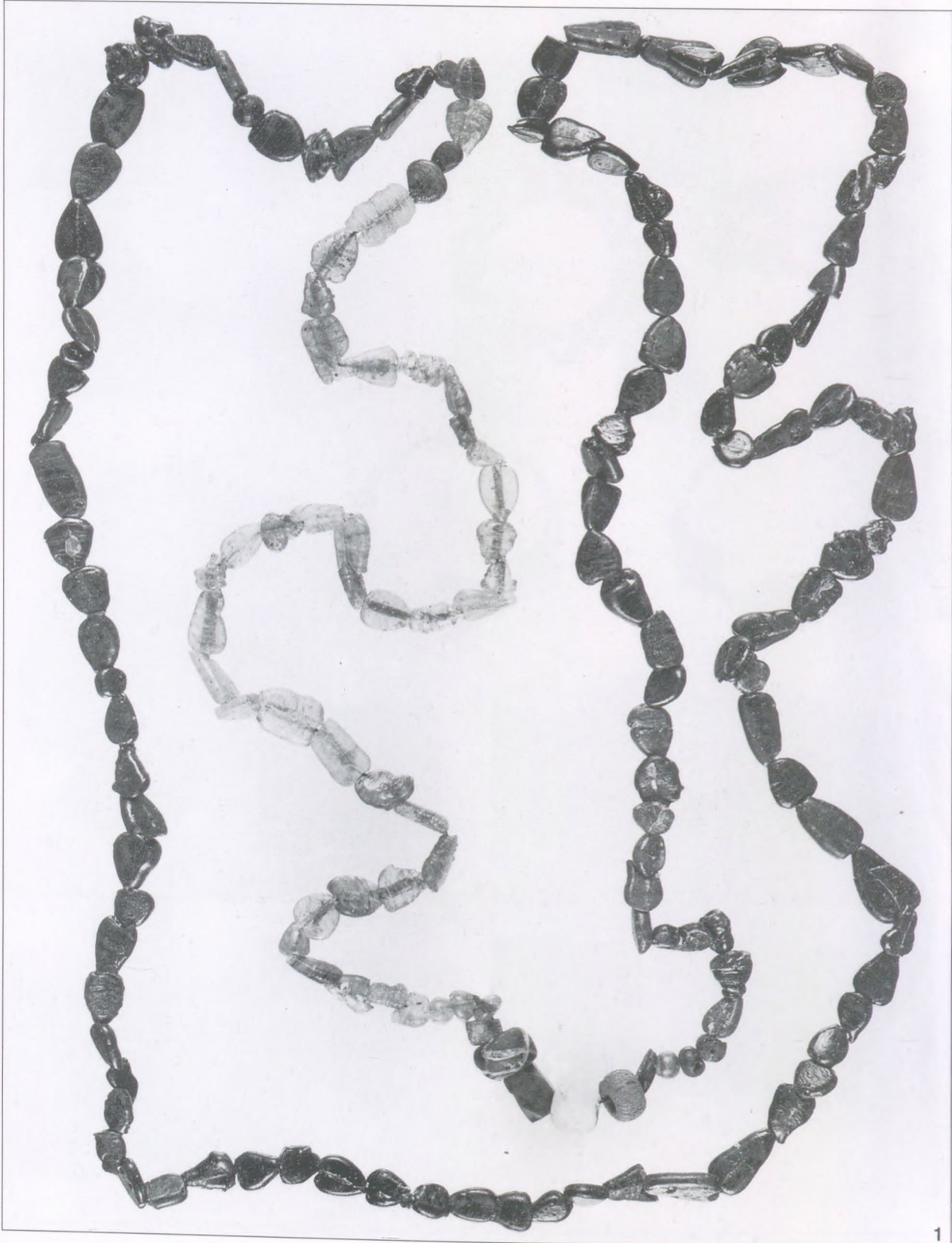

Taf. 142 1: Grab 398

KÖLKED – FEKETEKAPO B

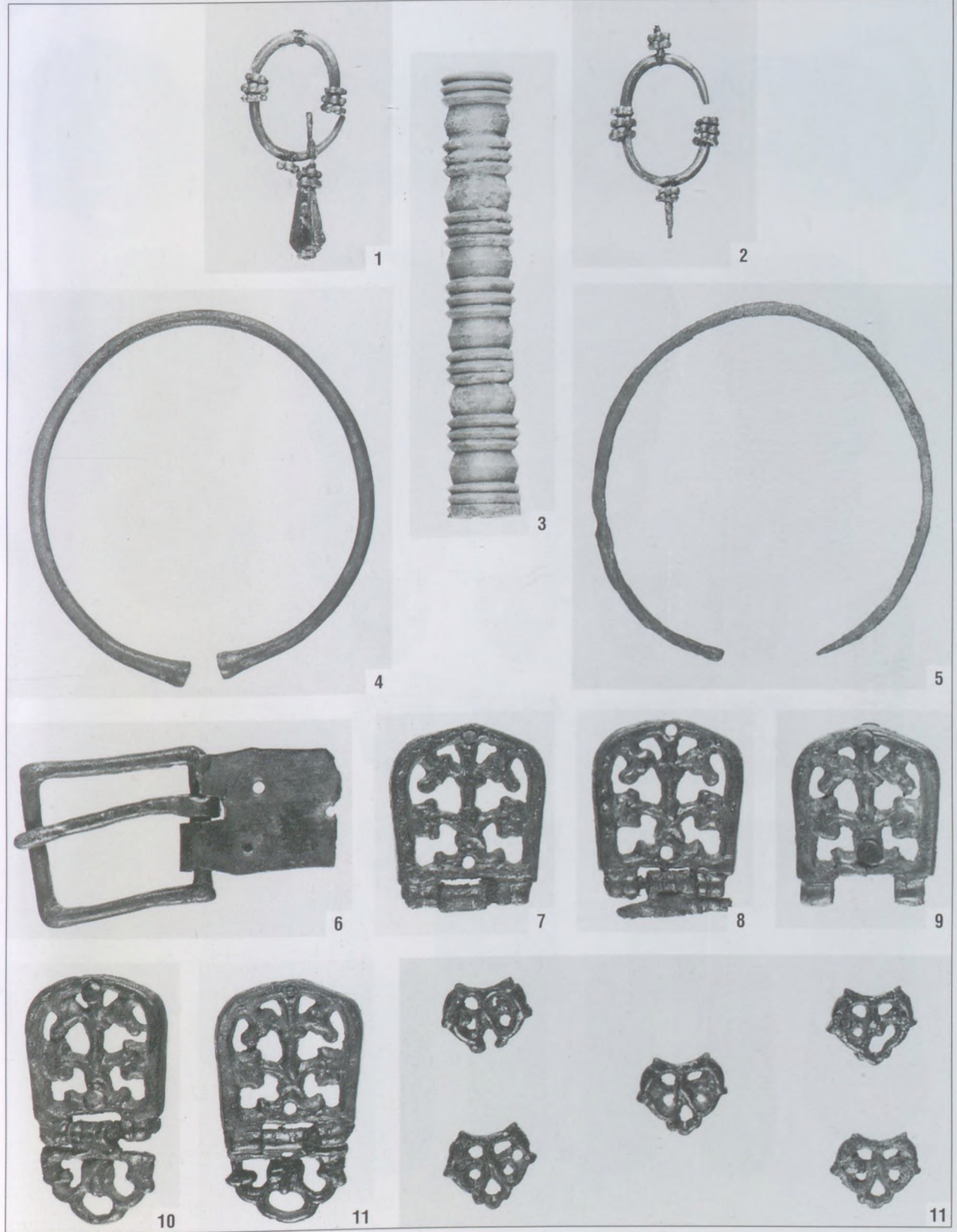

Taf. 143 1-5: Grab 398; 6-11: Grab 418

KÖLKED – FEKETE KAPU B

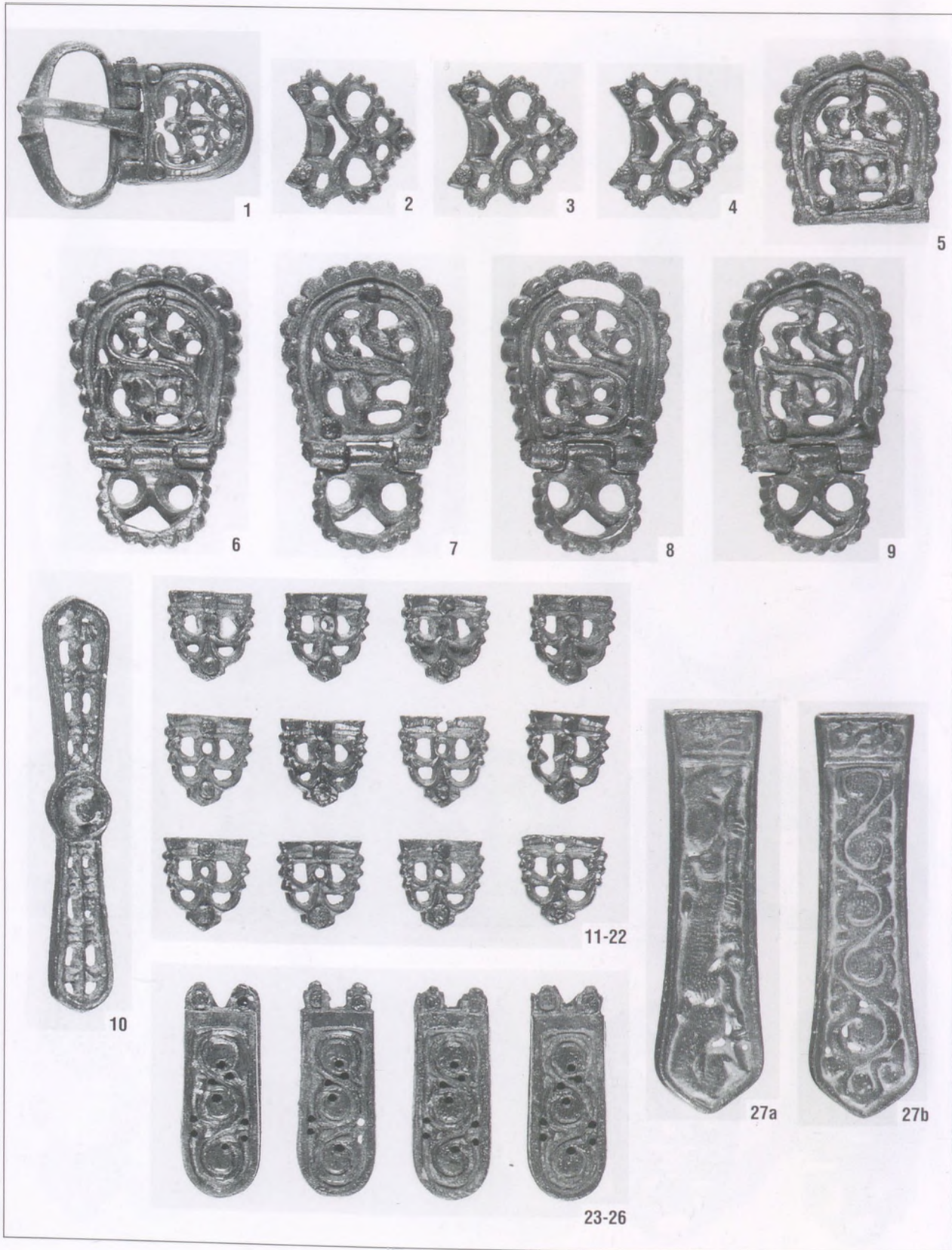

Taf. 144 1-27: Grab 402

KÖLKED – FEKETEKAJU B

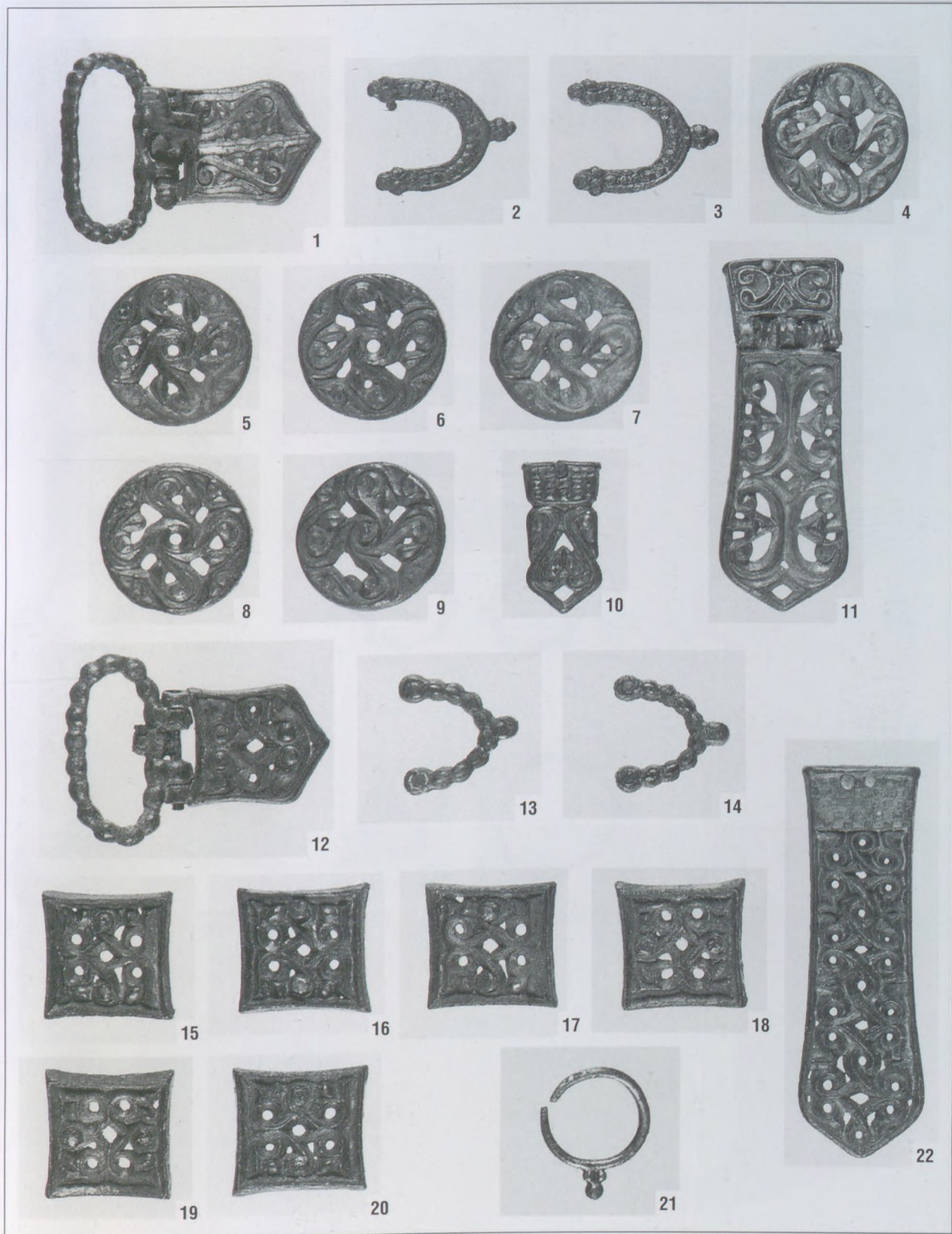

Taf. 145 1-11: Grab 419; 12-22: Grab 427

KÖLKED – FEKETEKAJU B

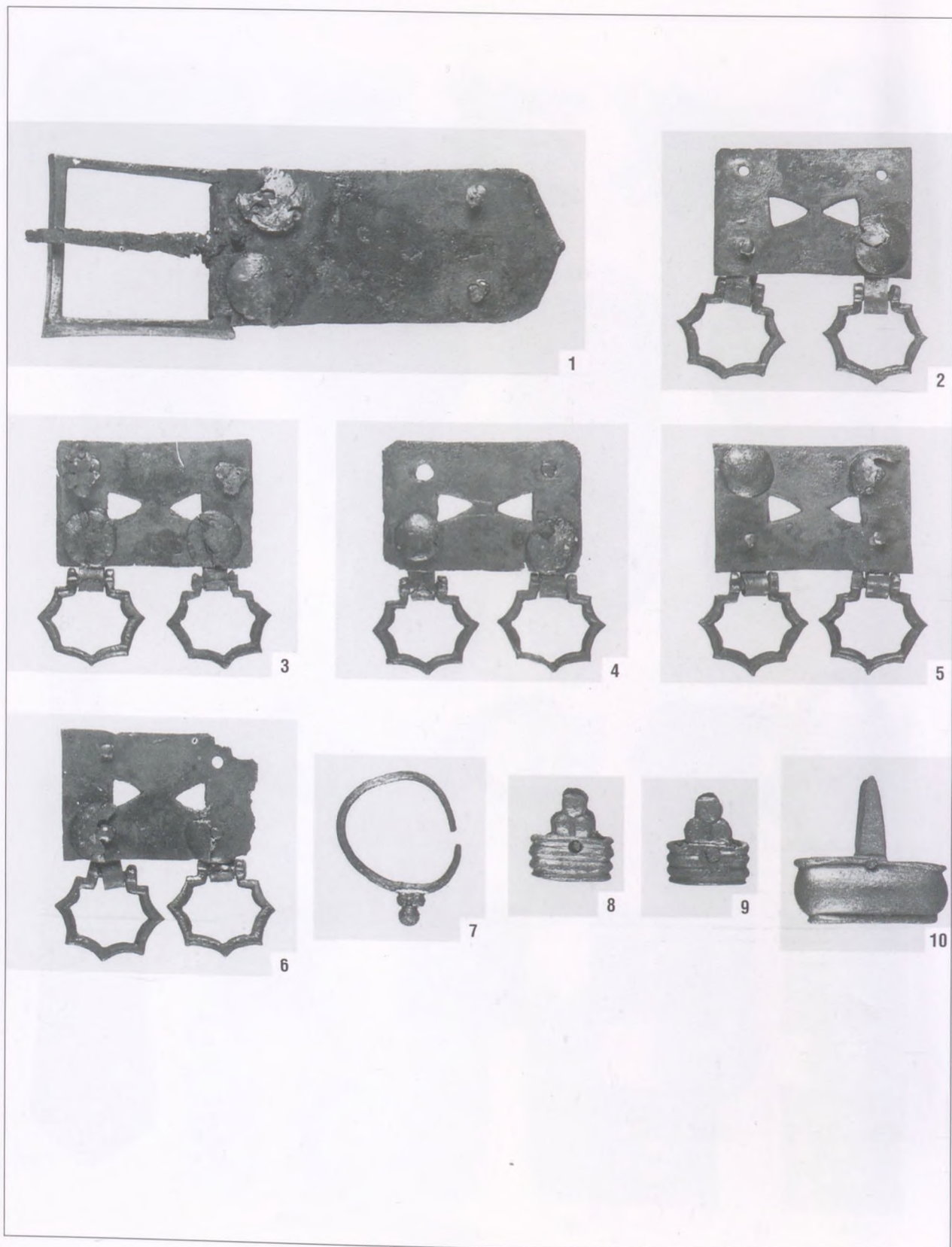

Taf. 146 1-10: Grab 420

KÖLKED – FEKETEKAJU B



Taf. 147 1-5: Grab 438

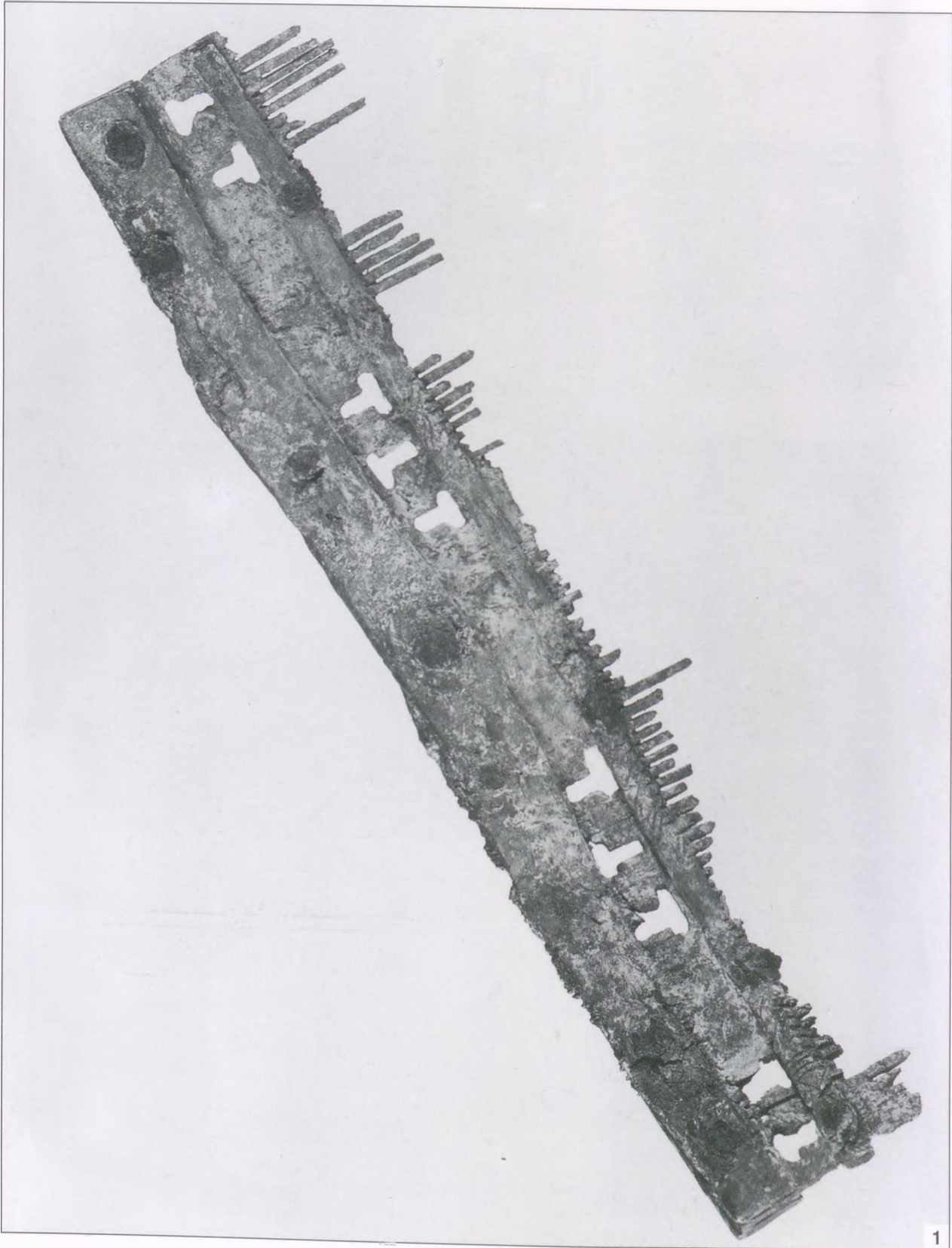

Taf. 148 1: Grab 438

KÖLKED – FEKETEKAPO B



Taf. 149 1-4: Grab 449; 5-6: Grab 450

KÖLKED – FEKETE KAPU B



Taf. 150 1-8: Grab 459; 9: Grab 491; 10a-b: Grab 496; 11: Grab 617

KÖLKED – FEKETEKAJU B

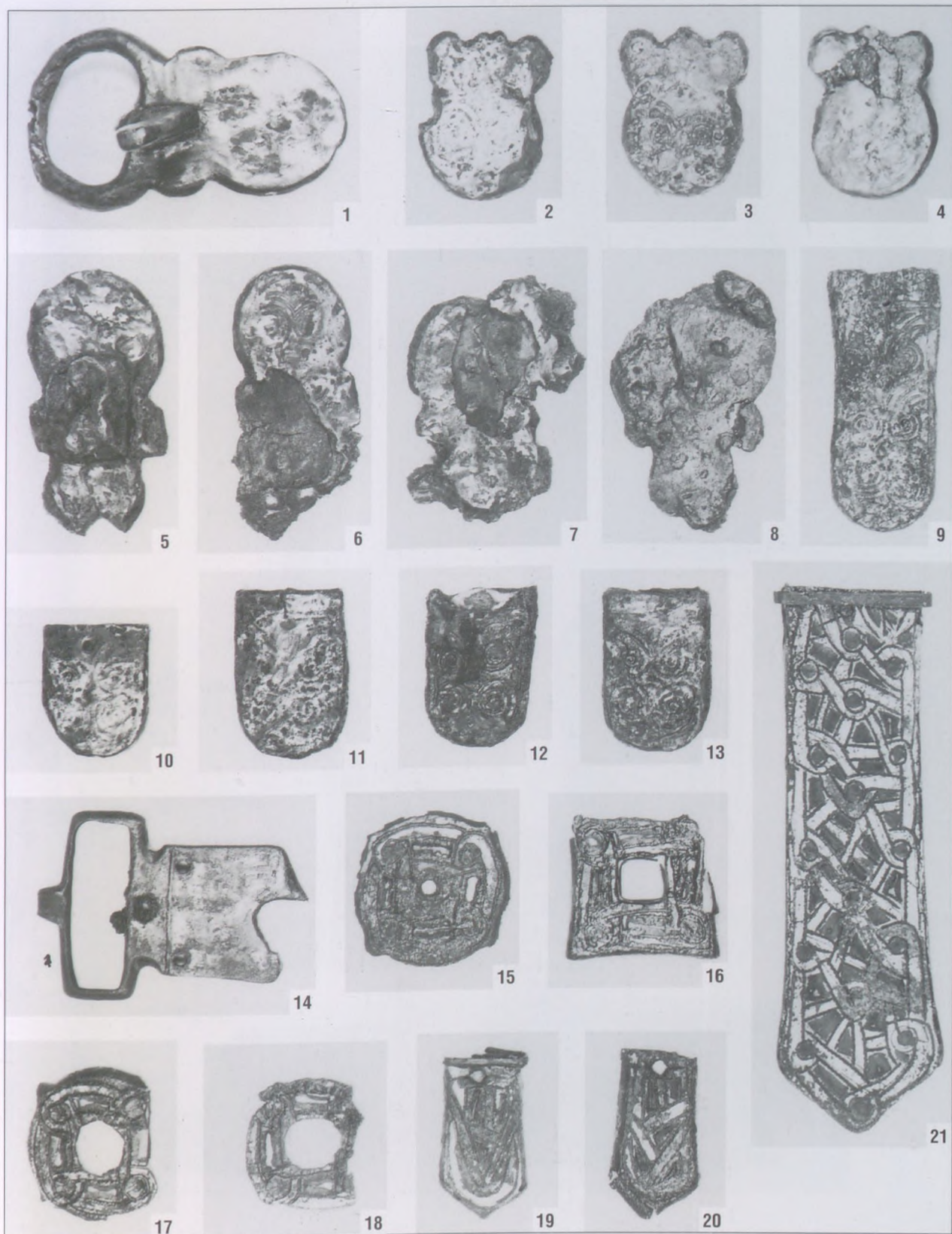

Taf. 151 1-13: Grab 470; 14-21: Grab 564



1



2



3

Taf. 152 1-3: Grab 541

KÖLKED – FEKETEKAPO B



Taf. 153 1-6: Grab 580; 7-10: Grab 629; 11: Grab 635

KÖLKED – FEKETEKAJU B

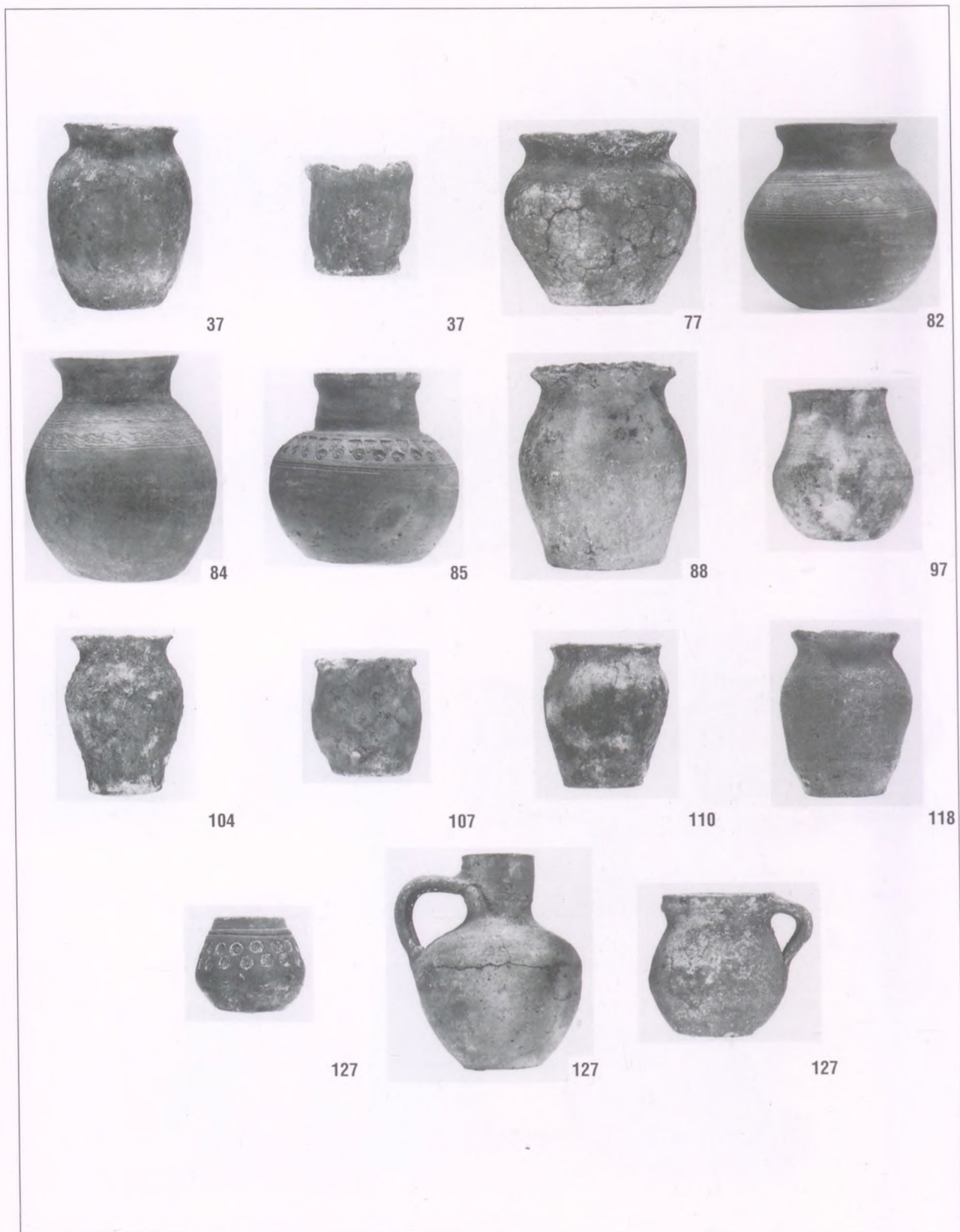

Taf. 154 Gräber 37, 37, 77, 82, 84, 85, 88, 97, 104, 107, 110, 118, 127, 127, 127

KÖLKED – FEKETEKAPU B



132



157



164



169



175



176



177



178



182



185



192



195



198



199



208

Taf. 155 Gräber 132, 157, 164, 169, 175, 176, 177, 178, 182, 185, 192, 195, 198, 199, 208

KÖLKED – FEKETE KAPU B



212



213



217



221



225



226



227



228



230



232



233



236



268



272



297



300



308



319



330



330

Taf. 156 Gräber 212, 213, 217, 221, 225, 226, 227, 228, 230, 232, 233, 236, 268, 272, 297, 300, 308, 319, 330, 330

KÖLKED – FEKETEKAPU B



334



335



345



351



353



406



419



421



436



437



447



451



453



458



461

Taf. 157 Gräber 334, 335, 345, 351, 353, 406, 419, 421, 436, 437, 447, 451, 453, 458, 461

KÖLKED – FEKETEKAU B



470



491



494



496



498



499



500



516



521



526



527



528



530



534



538



542

Taf. 158 Grüber 470, 491, 494, 496, 498, 499, 500, 516, 521, 526, 527, 528, 530, 534, 538, 542

KÖLKED – FEKETE KAPU B



548



553



555



556



557



564



570



575



577



582



583



586



588



624



628



646

Taf. 159 Gräber 548, 553, 555, 556, 557, 564, 570, 575, 577, 582, 583, 586, 588, 624, 628, 646

FARBTAFELN I-VIII

KÖLKED – FEKETEKAPU B



1



2



3



4

Taf. I 1-4: Haarnadel, Ohrgehänge und Fingerring aus dem Frauengrab 85



Taf. II 1-4: Schnalle aus dem Frauengrab 85



1



2



3



4

Taf. III 1-4: Schnallenbeschlag, Gurtelbeschlage und Riemenende aus dem Frauengrab 85



Taf. IV 1-3: Scheibenfibel und Armband mit Monogram aus dem Frauengrab 119

KÖLKED – FEKETEKAPO B



1



2



4



4



5

Taf. V 1-5: Armband mit Steineinlage, Silberbeschlag eines Holzschale und Goldbeschläge von Messerscheiden aus dem Frauengrab 119



Taf. VI 1-5: Goldbeschläge einer Holzschale, Fingerring und Solidi aus dem Frauengrab 119

KÖLKED – FEKETEKAPO B



1



3a



2



3b



4

Taf. VII 1-4: Schnalle, tauschierte Riemenende, Augenperlenkette und Eisenmesser mit Goldbeschlag aus dem Frauengrab 173



Taf. VIII 1: Silberkreuz mit Steineinlage aus dem Grab 449;

2: Silberfibel aus den Gräber 85 und 438;

3: gepresste Silberbeschlüge aus dem Grab 343;

4: Gürtelbeschlüge aus dem Frauengrab 459

MONUMENTA AVARORUM ARCHAEOLOGICA



- 1 **Irén Juhász:** Awarenzeitliche Gräberfelder in der Gemarkung Orosháza
1995, 123 p., 33 Abb., 45 Tafeln
- 2 **Margit Nagy:** Awarenzeitliche Gräberfelder im Stadtgebiet von Budapest I-II.
1998, 213 p., 93 Abb., 214 Tafeln
- 3 **Gyula Rosner:** Das awarenzeitliche Gräberfeld in Szekszárd-Bogyiszlói Straße
1999, 247 p., 37 Abb., 87 Tafeln
- 4 **Sarolta Tettamanti:** Das awarenzeitliche Gräberfeld in Vác-Kavicsbánya
2000, 173 p., 29 Abb., 47 Tafeln
- 5 **Éva Garam:** Funde byzantinischer Herkunft in der Awarenzeit vom Ende des 6. bis zum Ende des 7. Jahrhunderts
2001, 432 p., 24 Abb., 139 Tafeln, XL Farbtafeln und 1 Beilage
- 6 **Attila Kiss:** Das awarenzeitliche Gräberfeld in Kölked-Feketekapu B I-II.
2001, 472 p., 186 Abb., 159 Tafeln, VIII Farbtafeln
- 7 **Gyula László:** Das awarenzeitliche Gräberfeld in Csákberény (*in Vorbereitung*)

