

DAS AWARISCHE CORPUS

AVAR CORPUS FÜZETEK



Beihefte IV



Debrecen - Budapest
1995

CONTENTS

Preface (12)

Ágnes Salamon – Károly Cs. Sebestyén

THE SZEGED-KUNDOMB CEMETERY

Ágnes Salamon

THE SZEGED-MAKKOSERDŐ CEMETERY

Gyula Török

**THE CSENGELE-FEKETEHALOM
CEMETERY**

Translated by
† *Ágnes Cs. Sós*

Lectused by
István Bóna

© *László Madaras 1995*
Translation supervised by † *Ágnes Cs. Sós*

Debrecen-Budapest 1995

Das Awarische Corpus
Avar Corpus Füzetek

Beihefte IV.

Készült az OKTK „Kulturális hagyományaink feltárása, nyilvántartása és kiadása”
főirány, és az Ethnica Alapítvány, a Magyar Nemzeti Múzeum és a Csongrád megyei
Múzeumok Igazgatóságának támogatásával

Sorozatszerkesztő

Madaras László

A kötetet szerkesztette

Kourig Ilona,

Madaras László közreműködésével

Technikai szerkesztő

Pál Lajos

ISBN 963 472 114 1

Kiadó: Kossuth Lajos Tudományegyetem Néprajzi Tanszék Ethnica Alapítványa

Felelős kiadó: *Dr. Ujváry Zoltán* egyetemi tanár

Alle Rechte vorbehalten

CONTENTS

Preface (by *László Madaras*)

THE SZEGED-KUNDOMB CEMETERY (by *Ágnes Salamon – Károly Cs. Sebestyén*)

I. Excavation and site

1. The excavation of the cemetery
2. The site

II. Catalogue of graves

III. Burial customs

1. The grave pit
2. The deposition of the dead
3. Burial of horsemen
4. Traces of funeral feasts and food offerings
5. Skull robbery
6. Orientation
7. Disturbed graves
8. Other phenomena observed

IV. Grave goods

1. Dress and personal ornaments
 - (a) Male graves
 - (b) Female graves
 - (c) Children's graves
2. Tools, implements
 - (a) Male graves
 - (b) Female graves
 - (c) Children's graves
3. Weapons
4. Harness
5. Pottery

V. Summary

THE SZEGED-MAKKOSERDŐ CEMETERY (by *Ágnes Salamon*)

I. Excavation and site

1. The excavation of the cemetery
2. The site

II. Catalogue of graves

III. Burial customs

1. The grave pit
2. The deposition of the dead
3. Burials of horsemen
4. Traces of funeral feasts and food offerings
5. Skull robbery
6. Orientation
7. Disturbed graves
8. Other phenomena observed

IV. Grave goods

1. Dress and personal ornaments
2.
 - (a) Male graves
 - (b) Female graves
 - (c) Children's graves
2. Tools, implements
 - (a) Male graves
 - (b) Female graves
 - (c) Children's graves

3. Weapons
4. Harness
5. Pottery and metal vessels, wooden bucket
 - Wheel-made pottery vessels
 - Hand-made pottery vessels
 - Metal vessel
 - Wooden bucket

V. Summary

THE CSENGELE-FEKETEHALOM CEMETERY (by *Gyula Török*)

I. Excavation and site

1. The excavation of the cemetery
2. The site

II. Catalogue of graves

III. Burial customs

1. The grave pit
2. The deposition of the dead
3. Burials of horsemen
4. Traces of funeral feasts and food offerings
5. Skull robbery
6. Orientation
7. Disturbed graves
8. Other phenomena observed

IV. Grave goods

1. Dress and personal ornaments
2. (a) Male graves
- (b) Female graves
- (c) Children's graves

Bibliography

PREFACE

Hungarian Archaeology hopes to answer a long-standing question by the publication of volumes 3 and 4 of Avar Corpus Füzetek. These volumes consist of the descriptions of Avar Cemeteries excavated by Ferenc Móra, who died more than half a century ago. These cemeteries are probably among his most significant works. (The number of the opened graves is very high in these cemeteries.) The goal of these volumes is to make known the results of these excavations.

Volume 4 contains the description of the Csengele-Feketehalom Cemetery.

The five Cemeteries presented in Avar Corpus Füzetek may become the foundation of research on the Avar Period. They give data which may throw light upon the history of the Carpathian Basin between the 6th and 9th century AD. The history of this period has been at the centre of discussions for a long time. These cemeteries may be archaeological proof of the 2nd Avar Settlement which reshaped the political, cultural, economical and social structure of the Avar Empire.

The written sources have no reliable evidence for the 2nd Settlement of Avars.

The ethnic origin of the incoming people — which is Onogur Bulgarian in our opinion — has been the topic of discussion for decades.

The editors are grateful to all the excavators and colleagues who made this publication possible.

It is my pleasant duty to thank all those who have contributed to the issuing of this book: first of all, to Prof. István Bóna for the most careful and circumspect revision of the text, and for the many items of useful advice; to Prof. Otto Trogmayer superintendent of the Csongrád-County Museums; to Mrs. Ágnes Cs. Sós, and Mihály Sándory for the translation of the Hungarian text into English. For the illustration of this book I am indebted to Mr. Ágoston Dékány, Mrs. Ida Szatmári, and for the maps to Mr. Ernő Lék.

László Madaras

PREFACE

Volume 4 contains the description of the material from the five cemeteries mentioned in the text. The five cemeteries mentioned in the text are: the cemetery at the site of the Avaz (Avaz) cemetery, the cemetery at the site of the Avaz (Avaz) cemetery, the cemetery at the site of the Avaz (Avaz) cemetery, the cemetery at the site of the Avaz (Avaz) cemetery, and the cemetery at the site of the Avaz (Avaz) cemetery. The goal of this volume is to present the results of these excavations.

ABBREVIATIONS USED IN THE TEXT

D = Depth	F = Female	Juv. = Juvenile	r = right side
L = Length	Ch = Child	Mat. = Mature	l = left side
W = Width	Anthr. = Sex as determined by Anthropologists	Sen. = Old	H = Height
Di = Disturbed		N = North	fd = Flange diameter
Ls = Length of the skeleton	Inf. I.	E = East	fb = Bottom diameter
M = Male	Inf. II.	W = West	
		S = South	

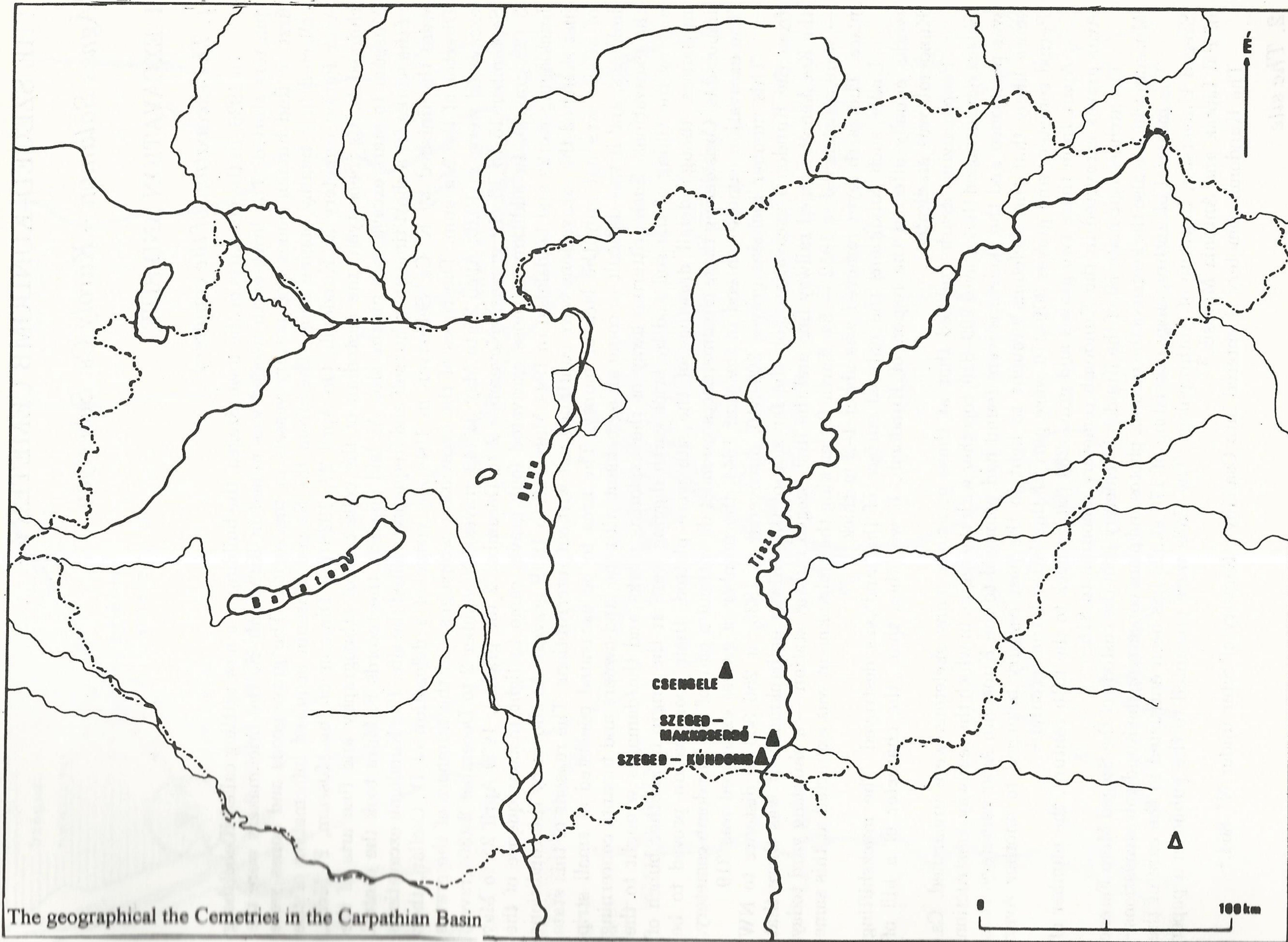

The geographical the Cemeteries in the Carpathian Basin

THE SZEGED-KUNDOMB CEMETERY

Ágnes Salamon – Károly Cs. Sebestyén

I. EXCAVATION AND SITE

1. *The excavation of the cemetery*

In 1926, in the outskirts of the town Szeged, the building of a new settling called Klebelsberg quarters started. The brick-earth needed was mined in Kundomb. So the brickmakers were the first to find human bones and pottery vessels in the region. The grave-goods and bones were collected in a nearby engine shop. Therefrom the Szeged Museum acquired information of the Avar Period cemetery at Kundomb. On April 27, 1926 the Director of the Museum, F. Móra, charged K. Cs. Sebestyén, the custodian of the collection of ethnography and fine arts of the Museum to start excavations on the site. As laid down in the records F. Móra took the control of the works for a short time upon himself and frequently visited the site. The Kundomb excavations were finished by K. Cs. Sebestyén in 1944, by virtue of a delegation of D. Csollán, then Director of the Museum. The times of the excavation campaigns and the numbers of the graves excavated were: in 1926: April 26 to May 31 (49 graves), November 2 to December 2 (30 graves) September 15 to 18 (12 graves), November 2 to December 2 (30 graves), 1929 April 25 to May 3 (32 graves). In addition to those excavated four graves came to light in consequence of the bricklaying works and landslides; in 1944 March 16 to 18 (9 graves). As shown by the conditions just sketched the excavations were continued not without interruptions. The reasons of this state of affairs was not only the lack of money. The area to be excavated consisted of small strip holdings, and it was difficult to come an agreement with the land-owners and tenants concerning the excavations. Such frittering away of the exploring works and the damages wrought to the site by the tilling of the soil and by brick-earth digging were at the origin of another bunch of nuisances: though detail drawings of the site were plotted, their coordination proved to be impossible. Considering these circumstances we must do without a plan of the Kundomb cemetery. The excavation came to an end in the year 1944, the number of graves excavated was 319.

This number includes graves 309–310, discovered in 1935, at 250–300 m distance to NW from the Kundomb excavations, on the far side of the railway embankment. It was there that the Kecskemét–Szeged railway line and the first Szeged railway station — a shunting yard today — were constructed in 1852 — 54. Earth for making the embankment was extracted at this same place. The earth layer removed was about 1–2 m thick.

Under such conditions the natural surface of the land was destroyed. The muckshifting works equally affected the region of Kundomb. It was then that „the character of a hill of Kundomb was eradicated”.

People living nearby related that at these occasions many skeletons were unearthed. Cs. Sebestyén surmised that graves 309–310, together with the region in which the railway construction was performed and the skeletons were found had belonged to the Kundomb Avar cemetery. It is more likely that the skeletons brought to light in the past century belonged to another Avar Period cemetery and graves 309–310 were part of this latter burial ground.¹

Apart from these two graves and grave 260 dating back to the fifth century, the number of Avar graves excavated in the Kundomb cemetery amounts to 316.

The archaeological material of the Kundomb cemetery is in the custody of the Szeged Móra Ferenc Múzeum which is also the keeper of the records, photos and plans concerning the Kundomb excavations.²

The material of anthropology consisting of 176 skulls has been entrusted to the care of the Szeged University, Institute of Anthropology. The finds were presented to the public in a paper of Pál Lipták and Antónia Marcsik.³

The Kundomb cemetery is entered into Csallány's Registry of Sites under N° 864.⁴

2. *The site*

Kundomb is situated to the S of the Szeged district Alsóváros, at a distance of 350–400 m apart, in the proximity of the railway shunting yard (Fig. 1). As pointed out above, the surface of the land was first disturbed by the construction of the railway line. Another encroachment on

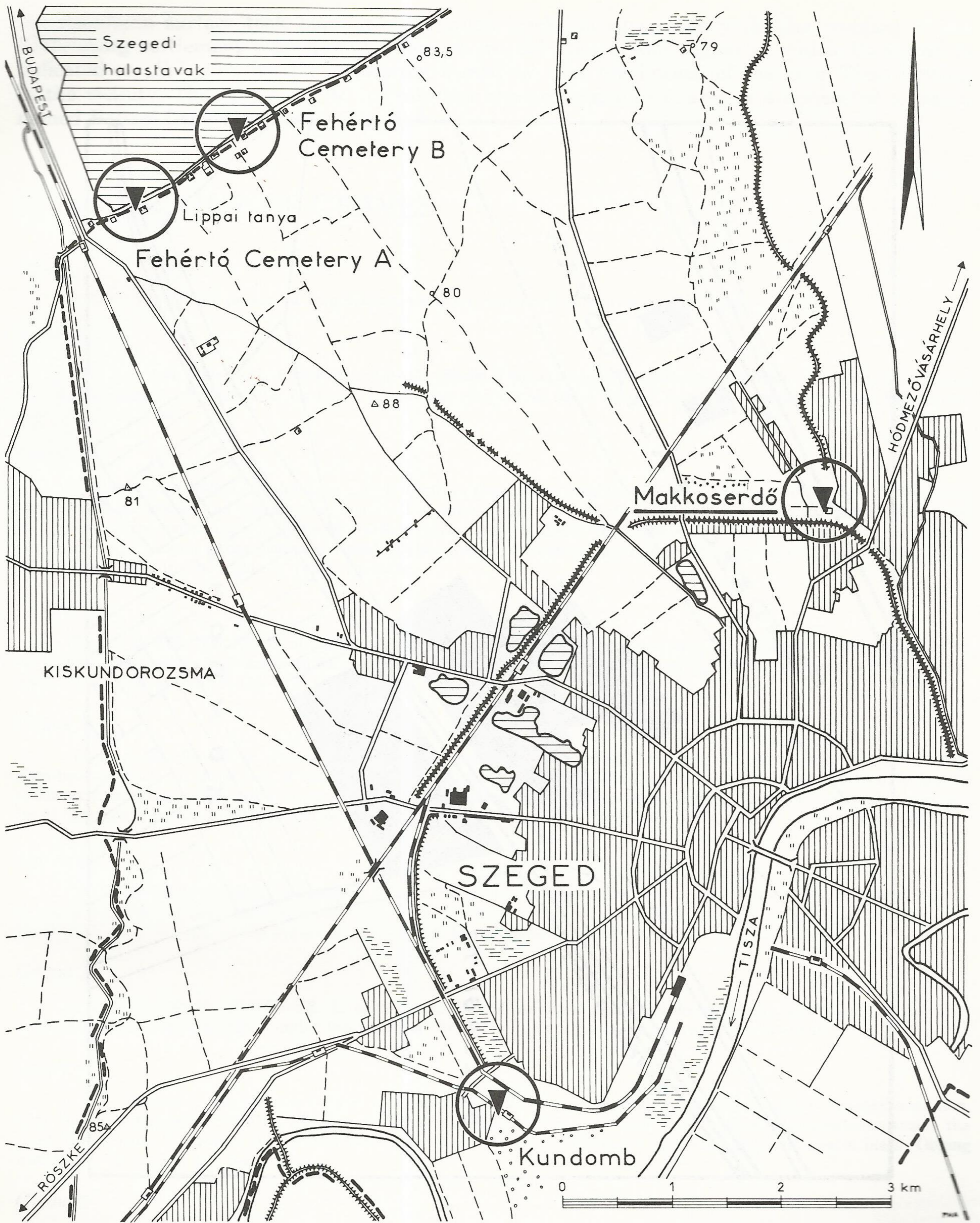

Fig. 1. Map of the area

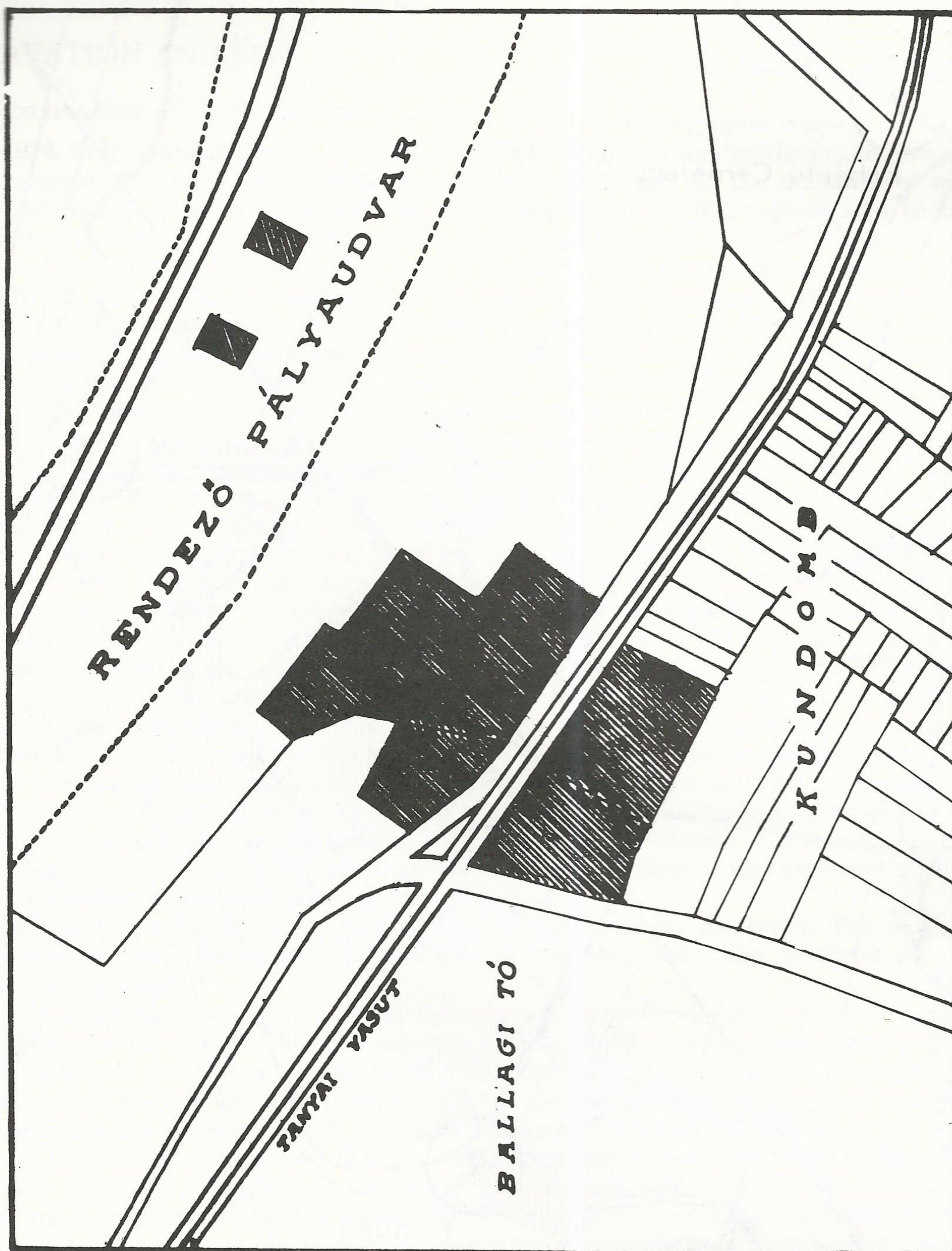

Fig. 2. Sketch plan of the excavated area

the Kundomb surface took place in 1926 when brickmaking necessary for the erection of the Klebelsberg settlement was started. There is an old plan of the region in which Kundomb is indicated as „Sebesfok hátja”, apparently named so after the branch of the river Tisza flowing in the vicinity. The only thing to indicate the one-time catchment area is a desiccated lowland, named Ballagi Lake even today (Fig. 2).⁵

II. CATALOGUE OF GRAVES

Grave 1

D: 120; NW-SE. Ill-preserved fragmentary skeleton recovered in saturated soil. No grave-goods.

Grave 2

(Pl. 1.) D: 140; NW-SE. L. of skeleton: 100. Ch. Skeletal bones and skull in decayed condition recovered in saturated soil. Quadrangular iron *buckle* (2) on the r. ilium. *Iron ring* (1) on the l. ilium. *Charcoal* under the r. knee. *Egg* on the bones of the r. hand.

Grave 3

(Pl. 1.) D: 175. N-S. L. of skeleton: 118. F. Skull in fragmented condition. Biconical clay *spindle-whorl* (3) decorated with incised horizontal and zigzag lines; „on the l. shoulder”. Glass *beads* (4) between the r. ilium and the thorax; black and light-coloured melonseed-shaped beads, various in size, and one larger volourless bead of the same type. Two penannular br. *earrings* (1), one on either side of the skull. *Pottery vessel* (5): coarse, hand-made pot, greyish in colour; h: 11; rd: 11; bd: 7. *Fowl bones* in the region of the r. shoulder.

Grave 4

(Pl. 1.) D: 150. NW-SE. L. of skeleton: 180; M (?). Well-preserved skeleton with skull lying in a tilted position on its l. side. Fragmentary iron *knife* under the bones of the r. forearm. *Fowl bones* and *egg* under the bones of the l. hand. *Bones of a small animal* to the r. of the r. femur.

Grave 5

(Pl. 1.) D: 90. NW-SE. L. of skeleton: 150. F. Fragmentary skull found tilting to its r. side. Br. *earring* (1) with globular glass bead-pendant; on the r. side of the skull. Melonseed-shaped glass *beads* (2), light green and blueish-brown in colour, so about sixty in number; they were found scattered in some places: in the region of the cervical vertebrae, among the ribs and inside the mouth cavity. *Fishbones* and *bone of a small animal* near the l. arm; *fowl bones* on the l. part of the chest.

Grave 6

(Pl. 1.) D: 100. NW-SE. L. of skeleton: 75. Ch. Skeletal bones recovered in decayed condition. Burnt lumps of earth in the grave-filling. Glass *beads* (2) around the cervical vertebrae; melonseed-shaped beads and two small globular ones in black. *Fishbones* and *egg* in the region of the l. hand. *Egg* between the feet (?).

Grave 7

D. 135; L: 190; W: 80. NW-SE. L. of skeleton: 160. F. Adultus. Anthr. Skeleton found „at the side of the pit;” crushed skeletal remains. *Ashes* under the bones of the r. hand. *Fowl bones* in the region of the skull.

Grave 8

(Pl. 1.) D: 145; L: 220; W: 60. NW-SE. L. of skeleton: 160. Decayed skeletal bones, skull, found in crushed condition, lying in a tilted position. Two br. *earrings* (1), a circular and an oval one, with small hollow globe-pendants; inside the skull. Glass *beads* (2) around the cervical vertebrae; yellow milletseed-like beads and small globular ones in black. Oblong iron *buckle* (3) within the pelvic area.

Grave 9

(Pl. 1.) D: 80; L: 180; W: 80. NW-SE. L. of skeleton: 160. F. Circular silver *earring* with large hollow globe-pendant; on the l. side of the skull. Four-sided glass *bead* (2) in white, in the region of the cervical vertebrae. Br. *braceles* (6) with slightly thickened terminals, circular in section; one on each forearm. *Bracelet* (5) made of br. plait, on the r. forearm. *Iron ring* (3) on the l. part of the chest. Disc-shaped *spindle-whorl* (4) cut out of a grey pottery sherd.

Grave 10

(Pl. 1; Pl. XV. 4; Pl. XX. 3). D: 175; L: 200; W: 70. N-S. F. Adultus. Anthr. *Iron fragment* (+) to the l. of the skull. Penannular br. *earring* (1) under the chin. Light-coloured melonseed-shaped glass *beads* (6) in the region of the

cervical vertebrae. Quadrangular iron *buckle* (5) on the l. part of the chest. Biconical clay *spindle-whorl* (3), grey in colour, decorated with incised horizontal and zigzag lines; by the r. hand. Iron *knife* under the bones of the r. forearm. Bone *double-combe* (4) with midrib decorated with a row of engraved hexagons; „in the l. hand”. Iron *fragment* (2) on the bones of the l. leg, near the phalanges of the l. hand. *Pottery vessel* (7) by the l. humerus; hand-made grey pot showing vertical slashed ornament on the edge of its everted rim; h: 13,5; rd: 10; bd: 8. *Animal bones* (ribs) and *fowl bones* in large quantity; in the region of the skull and in the region of the cervical vertebrae.

Grave 11

(Pl. 2.). D: 100; L: 200; W: 70. NW-SE. L. of skeleton: 160. F. Oval br. *earring* (1) with glass bead-pendant missing; on the l. side of the skull. Biconical clay *spindle-whorl* (2), grey in colour, decorated with incised horizontal and zigzag lines; in the grave-filling (?). Oval iron *buckle* (3). *Chicken bones* within the pelvic area.

Grave 12

(Pl. 2). D: 175; L: 210; W: 80. NW-SE. L. of skeleton: 145. F. Skull found tilting to its r. side, mandible displaced by the pressure of earth. *Ashes* under the bones of the l. foot (2). *Chicken bones* in large quantity found lying in a heap near the the ashes. Two circular br. *earrings* (2), each with a cylindrical pendant tipped with a globular glass bead in dark blue; under the skull. Broad-bladed iron *knife* by the r. hand. Trapezoidal iron *buckle* (3) near the outer edge of the r. ilium. biconical clay *spindle-whorl* (4) outside the l. elbow. Fragment of a thin br. *pin* (?; 1) from the same position.

Grave 13

(Pl. 2). D: 135; L: 230; W: 80. NW-SE. L. of skeleton: 140. F. Maturus. Anthr. Skull found tilted forward, humeri in line with the skull; bones of the legs badly crushed. Two penannular br. *earrings* (1) with overlapping terminals; one on either side of the skull. Two *flints* (4), one under the pelvis, the other between the legs. Fragmentary iron *strike-a-light* from the same position. Several melonseed-shaped glass *beads* (2), green in colour, round the pelvis. Quadrangular iron *buckle* (3) near the l. hand. *Chicken bones* and a piece of *charcoal* under the bones of the feet (?).

Grave 14

(Pl. 2). D: 165; L: 170; W: 80. NW-SE. L. of skeleton: 120. F. Fragmentary skeletal remains, skull found tilting to its r. side. Penannular br. *earring* (1) inside the skull. Narrow-bladed iron *knife* on the r. ilium. Oval iron *buckle* (2) with oblong beltplate, on the l. ilium. *Ashes* round the skull. *Fishbones* on the chest; piece of *charcoal* in the middle of the pelvis.

Grave 15

(Pl. 2). D: 165; L: 200; W: 80. NW-SE. L. of skeleton: 150. F. Senilis. Anthr. Skull found tilting to its r. side. Two circular br. *earrings* (1), one on either side of the skull; each with a pendant originally made up of cone-frustum type setting and glass bead, only the globular black beads survived. Biconical clay *spindle-whorl* (3), grey in colour, on the l. elbow. Quadrangular iron *buckle* (2) on the l. ilium. Small iron *knife* under the bones of the r. forearm.

Grave 16

D: 125. NW-SE. M (?). Maturus. Anthr. Skull found in fragmented condition. *Pig bones* in the grave-filling.

Grave 17

(Pl. 2; Pl. XVI. 3). D: 130; L: 130; W: 60. NW-SE. L. of skeleton: 105. Ch. Bones of the skeleton in decayed condition, skull found badly shattered. Two *strings of beads* (2); one of the strings consists of yellow milletseed-like glass beads, the beads of the other are of melonseed-type, dark blue in colour; the beads were found around the cervical vertebrae and on the ribs down to the line of the waist. Cast br. *crescent-shaped pendant* (lunula; 3) with a triangular projection in its middle, decorated with punch-work consisting of dots and small rings; it was strung in the middle of one of the necklaces. Fragmentary penannular br. *earring* (1) under the lunula; a similar earring near the skull. Iron-bound wooden *bucket* by the r. hand; fragmentary iron fittings bearing traces of wood; original h: 14; rd: 12; bd: 11; construction: three hoops and two side-bands fitted with rings for fastening the handle. *Eggs* inside the bucket and on the r. part of the chest. *Animal bones*, mainly fowl bones, near the l. foot.

Grave 18

(Pl. 3; Pl. VI. t. 1-6; Pl. XI. 7). NW-SE. L. of skeleton: 150. M. *Mount-decorated belt*. Cast br. *large strap-end* (4); decoration: flat-leaf tendril with separate foliate offshoots, smilias designe on the surface of the socket. Three cast br. *small strap-ends* (6), each decorated with two S-shaped tendrils; base with a „slit” to fasten the strap. Six discoid *belt-mounts* of cast br. (1); decoration: swastika-like tendrils in openwork. Br. *buckle* (2): oval loop cast in one piece with its shield-shaped belt-plate showing plant pattern. Five oblong *belt-hole guards* of silver plate (7), fashioned from br. plate. *Propeller-shaped mount* of br. plate (7). Broad-bladed iron *knife* on the r. pubical bone. Br. *rattle* (3) decorated with a horizontal zone of grooves; on the outer edge of the r. ilium.

Grave 19

(Pl. 2.). D: 110; L: 190; W: 110. NW-SE. L. of skeleton: 162. F. Oblong iron *buckle* (2) within the pelvic area. Iron *strike-a-light* (1) and fragmentary iron *knife* in the same position. *Chicken bones* and *pig bones* near the feet. *Egg* of larger size in the region of the l. elbow.

Grave 20

(Pl. 2). Grave-pit with projecting ledges, one along each of the long sides. D: 150; L: 150; W: 150. Db. by sinking a shaft (W: 50; d: 90) in the centre of the grave. The skull was found lying in one of the corners of the grave-pit, and a half meter higher than the skeletal bones (in another layer of the filling). Two openwork cast br. *mounts for the pendent straps* (4), shield-like in shape; one of them near the skull, the other „under the humerus”. Cast br. shield-shaped *belt-hole guard* (1) decorated with plant pattern; from the same position. Cast br. *small strap-end* (3) showing flat-leaf tendrill decoration, two confronted geometrized animal heads as decoration of the upper part of its socket. Cast br. shield-shaped *belt-mount* with pendant missing (2), with flat-leaf tendrill motifs; the mount was found „on a leather strap” occurring under the pelvis. Iron *knife* „in the r. hand”. Iron *clanch-nails* for a coffin (5). *Fowl bones* in the region of the feet.

Grave 21

D: 90; L: 140; W: 60. NW-SE. L. of skeleton: 70. Ch. Arch. F. Adultus. Anthr. *Pig bone* (rib) lying across the bones of the legs. *Egg* „in the r. hand”.

Grave 22

(Pl. 3). Grave-pit with projecting ledges, one at each of the long sides. D: 200; L: 210; W: 130. NW-SE. L. of skeleton: 160. F. Two circular br. *earrings* with globular glass bead-pendants, „by the skull”. *Beads* (4) around the cervical vertebrae; cylindrical metal beads and glass beads: light greenish-blue melonseed-shaped types, small globular ones and segmented beads. Two br. *bracelets* (5) with slightly thickened terminals, one on each forearm. Biconical clay *spindle-whorl* (6), grey in colour, on the l. knee. Oblong iron buckle (3) in the middle of the pelvis. Iron *knife* „on the left side”. Pieces of a leather strip on the chest. *Leather remnants* in the region of the feet.

Grave 23

(Pl. 3; Pl. V. 1-7). D: 160; L: 200; W: 70. NW-SE. M. Senilis. Anthr. Skeleton lying with forearm bent so as to rest across the pelvis. Two penannular br. *earrings* (1) on the l. side of the skull. *Mount-decorated belt*; to judge from the position of the belt-ornaments. After the deceased had been deposited the belt, was placed onto the corpse. Cast br. hinged *buckle* (4) consisting of an oval loop and quinquangular belt-plate showing geometrical designe in openwork; reverse with projecting flangs pierced for fastening the plate to the belt. Seven (?) quadrangular openwork silver *belt-mounts* of repoussé (2), each with rivets on the reverse. Silver plate *large strap-end* (3) with front-plate decorated with interlace pattern in repoussé. *small strap-end* of silver plate (5) showing trellis pattern in repoussé. Two *small strap-ends* (6) decorated with plant pattern in repoussé. Two triangular *belt-mounts* of repoussé silver foil (9), openwork in the middle. Oblong silver *belt-loop* (8); upper part decorated with a femal half-length portrait depicted „en face” (Pl. 3). Three, horseshoe-shaped” *belt-hole guards* of silver plate (7), each with three rivets. Iron *armour-plate* (10) from a scale-armour wrapped in a piece of textile; from an unknown position. Oblong (,) iron *buckle* on the l. ilium. Long iron *knife* „in the r. hand”.

Grave 24

(Pl. 4). Grave-pit with projecting ledges, one at each of the long sides. D: 190; L: 145; W: 90-60. NW-SE L. of skeleton: 90. Ch. Two penannular silver *earrings* (1), one on the l. side of the skull, the other under the skull. *Beads* of various types (5) under the skull and to the l. of it, „at a distance of a span”; some octahedral granit and amber beads and glass beads of melonseed-, cylindrical-, and small globular type. Two *Roman coins* of the 4th century (2); „on the l. shoulder”, the other somewhat higher up. Two br. *bracelets* (6), rectangular in section, with slightly thickened terminals; one on each forearm. Oblong br. *buckle* (3) with iron tangué; probably below the pelvis. Twisted br. *pin* (4) by the l. hand. Iron *knife* to the l. of the l. elbow. *Pig bones* in the region of the feet; *fowl bones* under the bones of the r. hand.

Grave 25

(Pl. 4). D: 160; L: 130; W: 60. NW-SE. L. of skeleton: 80. Ch. Inf. II. Anthr. Circular iron *buckle* (1) with tongue missing, on the sternum. Circular iron *buckle* (2) within the pelvic area. Two iron *rattles* (3, 4); one of them in fragments (+), the other with an iron ring linked to its loop; a pebble enclosed in the latter. Two iron *knives* between the legs.

Grave 26

D: 150; L: 190; W: 70. NW-SE. L. of skeleton: 145. F. Juvenilis. Anthr. No grave-goods.

Grave 27

(Pl. 4). D: 160; L: 150; W: 70. NW-SE. L. of skeleton: 140. F. Fragmentary skull found displaced by the pressure of earth. Piece of *charcoal* under the ilium. *Bones of a small animal* by the r. foot. Fragment of an iron clanch-nail or of the fittings for a wooden bucket in the grave-filling.

Grave 28

The grave was destroyed during the building of a narrow-gange railway. No grave-goods.

Grave 29

(Pl. 4). D: 130; L: 170; W: 70. N-S. L. of skeleton: 130. F. Juvenilis. Anthr. Skeleton lying on its l. side with legs bent a knees and drown up. Oblong iron *buckle* within the pelvic area. *Chicken bones* by the l. hand.

Grave 30

Db. by brick-earth digging; only a callus-fragment was rescued. No grave-goods.

Grave 31

D: 120; L: 120; W: 60. NW-SE. L. of skeleton: 90. Ch. *Chicken bones* in the region of the feet. *Egg* „in the hand”.

Grave 32

(Pl. 4.) Grave-pit with projecting ledges, one at each of the long sides. D: 170; L: 200; W: 0-70. NW-SE. L. of skeleton: 150. M. Maturus. Anthr. Biconical clay *spindle-whorl* (1), grey in colour. Fragmentary quadrangular iron *buckle*. *Chicken bones* near the l. foot.

Grave 33

(Pl. 4.) D: 180; L: 100; W: 60. NW-SE. L. of skeleton: 70. Cs. Skeleton lying „with hands placed across the chest”. Melonseed-shaped glass *beads*, green, brown and black in colour. After the dead had been deposited „the whole body was covered by eggs”.

Grave 34

(Pl. 6.) Grave-pit with projecting ledges, one at each of the long sides. D: 170; L: 220; W: 100-80. NW-SE. L. of skeleton: 155. M. Skull found tilting on its l. side. Two br. *earrings* (1) with small blue glass bead-pendants, globular in shape; „by the skull”. Oblong iron *buckle* with incurved sides (2), in the middle of the pelvis. Oblong iron *buckle* (3) on the r. ilium (?). Three bone plates from the *grip of a bow* (1), by the r. forearm. *Pig bones* by the r. foot (one piece of them lying across the knee).

Grave 35

(Pl. 5; Pl. VII. 13-31.) Grave-pit with projecting ledges, one at each of the long sides. D: 300; L: 230; W: 120-80. NW-SE. L. of skeleton: 170. M. Senilis. Anthr. Small penannular silver *earring* (1) „by the skull”. Trapezoidal br. *buckle* (4) in the region of the r. shoulder. *Mount-decorated belt* placed on the grave-floor prior to the deposition of the corpse. Cast br. hinged *buckle* (3) consisting of an oval loop and belt-plate with flat-leaf decoration. Cast br. double-plate *large strap-end* (9); in the region of the l. forearm; decoration: flat-leaf tendrils inside a scalloped border; each paner with two projecting strap-fasteners in form of confronting animal heads. Ten cast br. *belt-mounts* with hinged ring-pendants (6); elongated shield-shaped upper parts decorated with S-shaped tendrils; each mount lying in following position: under the vertebral column, under the ilia and between the l. ilium and forearm. Four cast br. shield-shaped *belt-hole guards* (5), tendril-decorated. Rhomboidal cast br. *mounts for the pendant straps* (8), with pearled border, openwork in the middle; thirteen

Grave 36

(Pl. 4.) D: 220; L: 190; W: 55. NW-SE. L. of skeleton: 145. F. Adultus. Anthr. Oval br. *earring* (1) with globular glass bead-pendant in green; on the l. side of the skull. Biconical clay *spindle-whorl* (3) decorated with incised horizontal and zigzag lines; under the l. scapula. Oblong iron *buckle* (2) on the l. ilium (?).

Grave 37

NW-SE. Db. No grave-goods.

Grave 38

(Pl. 5; Pl. X. 1-12.) D: 150; L: 200; W: 70. NW-SE. L. of skeleton: 170. M. Maturus. Anthr. Belt decorated with ornaments cast of white metal. Hinged *buckle* (8) consisting of an oval loop and openwork belt-plate showing pearled border and foliate design. Openwork *large strap-end* (3); decoration: plant pattern of multi-florous type inside a scalloped border; type of strap-fastener: socket fitted with three projections for the rivets. Two *small strap-ends* (9) decorated with plant pattern two projections for the rivets. Seven *belt-mounts* with hinged pendants (5); openwork upper parts decorated with foliate design surrounded by a pearled border and pendants with plant pattern of the same type. Three openwork *belt-hole guards* (2). Six shield-shaped *mounts for the pendent straps* (1) decorated with plant pattern. *Propeller-shaped mount* (4) with pearled border, decorated with plant pattern of foliate-florous scroll type. *Belt-loop* (10) fashioned from br. plate, front surface decorated with lines of punch-work. Quadrangular iron *buckle* (7) under the pelvis. Long-bladed iron *knife* near the outer side of the l. femur. *Piece of iron* (+; bodkin for leather?) „under the back”, on the l. side. *Flint* (11) on the l. ilium (?). *Pottery vessel* (6): crude, hand-made pot of small size, blackish in colour; h: 11,5; rd: 8; bd: 6. *Egg* between the knees. *Fowl bones* and other *animal bones* within the pelvic area (?).

Grave 39

Child grave coming to light in the southern ditch situated along the railway. No grave-goods.

Grave 40

(Pl. 6.) D: 240; L: 240; W: 801. NW-SE. L. of skeleton: 160. M. Maturus. Anthr. Two oval br. *earrings* (1) with globular glass bead-pendants of „cornless cube” type, blue in colour; „by the skull”. Thirty-two black melonseed-shaped

glass beads (7) around the cervical vertebrae. Biconical clay *spindle-whorl* (2), grey in colour, decorated with girth-grooves; on the l. of the skeleton. Oblong iron *buckle* (6) under the pelvis. Iron *knife* „in the l. hand”. Br. *finger-ring* (3) with bezel formed by a spiral; on one of the phalanges of the l. hand. Cylindrical bone *needle-case* (5) with turned of multi-ribbed type; by the r. humerus. Two br. *bracelets* (4), circular in section, with slightly thickened terminals; one on each arm. *Fowl bones* under the bones of the r. hand and between the feet (.). *Egg* by the r. foot.

Grave 41

(Pl. 6). D: 150; L: 220; W: 80. N-S. L. of skeleton: 160. *Pottery vessel* near the feet; reddish hand-made pot; h: 17; rd: 8,5; bd: 10. „Traces of leather or those of textile” under the skull.

Grave 42

(Pl. 4). D: 200; L: 180; W: 70. NW-SE. L. of skeleton: 150. F. Maturus. Anthr. Two *flints* (3) in the region of the l. shoulder. Melonseed-shaped glass *beads* (4) in green and black, around the cervical vertebrae. Biconical clay *spindle-whorl* (2), grey in colour, in the region of the l. elbow. Quadrangular iron *buckle* (1) within the pelvic area. *Fowl bones* in large quantity by the l. knee. Piece of *charcoal* on the chest. „Black earth under the bones of the trunk.

Grave 43

(Pl. 6). D: 180; L: 240; W: 70. NW-SE. L. of skeleton: 175. M. Skeleton recovered in decayed condition with skull displaced by the pressure of earth (?); markedly bandy-legged. Grave-floor showing traces of burning; a layer of ashes, 2-3 em thick, 30 em above the skeleton. Quadrangular iron *buckle* (1) on the r. ilium. Oval iron *buckle* (2) under the r. caput femoris. Broad-bladed iron *knife* in the region of the r. hand. *Pottery vessel* (3) between the feet (?); hand-made thick-walled pot with quadrangular mouth, greyish-black in colour; h: 17; rd: 9,5; bd: 8,5.

Grave 44

(Pl. 7; Pl. XVIII. 1). D: 190; L: 200; W: 80. NW-SE. L. of skeleton: 150. F. Adultus. Anthr. Two circular br. *earrings* (1) with blue glass bead-pendants missing, hoops made of twisted wires; „by the skull”. Green melonseed-shaped glass *beads* (4), about thirty or forty in number; lentil-shaped amber bead among the glass beads; the beads occurred on the l. part of the chest within an area reaching to the l. elbow. Biconical clay *spindle-whorl* (2), grey in colour, decorated with incised horizontal and wavy lines; „by the l. arm”. Iron *knife* inside the l. arm. Pair of circular *braist-clasps* (3) on the chest; decoration: the surface, encircled with beaded wire, shows a cellwork set with blue and green glass, the cells, fashioned from beaded wire, are of various shapes: a circular central cell (with blue glass) surrounded by two rows of trefoil ones (with green glass) in a step-like arrangement; one of the braist-clasps is fitted with a circular loop projecting beyond its edge, the reverse of the other is fitted with a loop for sewing on the cloth. *Pottery vessel* (5) „at a distance of 15 cm from the l. foot”; hand-made red pot (Sarmatian?) with a strap-like carrier handle; decoration: irregularly painted vertical stripes in black; h: 24,6; rd: 11; bd: 9. *Pig bones* and *fowl bones* near the feet. *Egg* on the chest.

Grave 45

(Pl. 6). D: 170; L: 85; W: 70. NW-SE. L. of skeleton: 80. Biconical clay *spindle-whorl*, grey in colour, decorated with incised wavy lines. *Pig bones* and *fowl bones* in the region of the skull.

Grave 46

(Pl. 6). D: 110; L: 200; W: 80. N-S. L. of skeleton: 165. F. Traces of „silk cloth” in the region of the r. arm. Some black melonseed-shaped glass *beads* (3) under the cervical vertebrae. Biconical clay *spindle-whorl* (1), grey in colour, on the l. part of the chest. Oblong iron *buckle* (2) within the pelvic area. Two *eggs*, a bigger and a smaller one, in the region of the r. shoulder.

Grave 47

The grave came to light during the building the narrow-gauge railway, in the northern ditch situated along it. Skeleton in contracted position (?); badly crushed skeletal remains. No grave-goods.

Grave 48

(Pl. 7). D: 190; L: 200; W: 80. NW-SE. L. of skeleton: 140. F. Glass *beads* (4) around the cervical vertebrae; light-coloured and blue melonseed-shaped beads, two cylindrical ones in blue, one polyhedral bead of the same colour. Two oval br. *earrings* (1) with green glass bead-pendants of „cornless cube” type; one on either side of the skull. Pair of circular *braist clasps* (2) on the central part of the chest; eight-petalled rosette type with cells fashioned from twisted wire; ill-preserved, of one of the specimens only the back-plate could be rescued. Biconical clay *spindle-whorl* (3), red in colour, decorated with girth-grooves; by the r. hand. Br. „*button*” (?) with loop missing (+), near the breast-clasps. *Fowl bones* in the region of the skull.

Grave 49

(Pl. 7). Grave-pit with projecting ledges, two at each of the long sides; D. of the first „steps”: 140; D. of the second „steps”: 220; D: 265; L: 200; W: 140-80 - 60. NW-SE. L. of skeleton: 150. F. Senilis. Anthr. Two oval bronze-gilt *earrings* (1) with globular glass bead-pendants; one earring on the l. side of the skull, the other on the r. side of the cervical vertebrae. Light-coloured melonseed-shaped glass *beads* (5) around the cervical vertebrae. Two br. *bracelets* (2), circular

in section, with slightly thickened terminals; one specimen by the lower epiphyses of the l. radius and ulna, the other in the region of the r. elbow. Iron *knife* inside the l. arm. Oblong iron *buckle* (4) on the r. ilium. *Fowl bones* on the bones of the l. arm. Small fragment of a bone *needle-case* (3) under the fowl bones.

Grave 50

(Pl. 7). D: 220; W: 70. NW-SE. L. of skeleton: 150. F. Senilis. Anthr. Two penannular *br. rings* (1) „by the skull”. Light-coloured and blue melonseed-shaped glass *beads* (4) around the cervical vertebrae. Oblong iron *buckle* (3) within the pelvic area. Biconical clay *spindle-whorl* (2) decorated with an incised zigzag line, grey in colour; in the region of the l. elbow. Oval iron *buckle* (5; +). *Chicken bones* by the r. femur.

Grave 51

(Pl. 7). D: 130; L: 220; W: 90. NW-SE. L. of skeleton: 170. F. Adultus. Anthr. Fragmentary iron *strike-a-light* (1) by the r. hand. Oblong iron *buckle* (2) within the pelvic area.

Grave 52

(Pl. 8; Pl. III., 1-10). D: 180; L: 240; W: 90. NW-SE. F. Adultus. Anthr. - M. Arch. Decayed skeletal remains recovered in saturated soil, bones of the r. arm missing, skull displaced by the pressure of earth (.). Remnants of woven material (felt?) occuing in some layers like a wrapping around the skeleton. *Mount-decorated belt*. Cast *br. hinged buckle* (2) consisting of an oval loop and quinquangular belt-plate, openwork in the middle. Four quadrangular *belt-mounts* of silver plate (1), each furnished with four rivets, one in each corner. Oblong-shaped silver plait *belt-mount* (8) with four rivets, one in each corner. Two silver plate *strap-ends* (7), short and broad in shape, each with a fluted silver band at its upper edge; one on either long side of the oblong-shaped mount. Two triangular *mounts* of silver plate (6), each furnished with three rivets, one on either short side of the oblong-shaped mount. Two silver plate „horseshoe-shaped” *belt-hole guards* (5), each with three rivets. *Belt-loop* (3) fashioned from *br. band*, with front-plate decorated with interlace pattern in repoussé. „*Propeller-shaped*” *mount* (4) made of silver plate. Two oblong *br. mounts* (11). *Iron ring* (9) under the ribs, to the left of the vertebral column. Trapezoidal iron *buckle* (10) under the pelvis. Long iron *knife* near the outer side (?) of the l. femur.

Grave 53

(Pl. 8; Pl. VI. 8-14). The grave had been disturbed by labourers of the brick-yard but the bones of the skeleton and the archeological finds accessed into the museum. F. Adultus. Anthr. - M. Arch. Double-plate cast *br. large strap-end* (1) bearing flat-leaf decoration; each panel with two projecting strap-fasteners in form of animal heads facing each other. Three cast *br. double-plate small strap-ends* (1) with similar decoration; each panel with projecting strap-fasteners in form of two confronted animal heads. Cast *br. hinged buckle* (6) consisting of an oval loop and tendril-decorated belt-plate (+). Two cast *br. belt-mounts* with hinged pendants (5); shield-shaped upper parts and pendants bearing flat-leaf pattern; pendant from a belt-mount of the same type (3). Two cast *br. shield-shaped belt-hole guards* (4), tendril-decorated specimens. Cast *br. mount for the pendent straps* (2) with pearled border, rhomboidal in shape, openwork in the middle.

Grave 54

(Pl. 8). D: 100; L: 180; W: 65. NW-SE. L. of skeleton: 155. F. Skull, found tilting to its l. side, lying somewhat lower than the bones of the feet. Quadrangular iron *buckle* (2) above (?) the l. shoulder. Glass *beads* (3) under the chin; one green melonseed-shaped bead and two melonseed-like ones. Two circular *br. earrings* (2) with pendants each made up of a circular setting and globular glass bead-pendant in blue. „by the skull”. Oblong iron *buckle* (4) „in the hollow of the l. hand”. Iron *knife* beside the former buckle. Cylindrical bone *needle-case* (5) with turned „ball-and ribs” decoration.

Grave 54/a

(Pl. 8). The grave was found during the excavation carried out on a plot belonging to the track-watchman; the site had been disturbed by earth removal when building the railway-embankment. Penannular *br. ring* (1). Lower part of a hand-made *pottery vessel* (2) in the grave-filling; h: 5,5; bd: 10,6.

Grave 55

(Pl. 9). D: 130; L: 220; W: 80. NW-SE. L. of skeleton: 160. M. Fragment of a *br. penannular earring* (1). Iron *knife* on the l. of the skeleton. Small circular iron *buckle* (2) under the l. ilium. Quadrangular iron *buckle* (3) under the r. ilium. Iron *buckle* with incurved sides (4) on the r. ilium.

Grave 56

(Pl. 9). Grave-pit wit projecting ledges, one at each of the long sides. D: 150; L: 220; W: 60-30. NW-SE. F. Adultus. Anthr. Large circular *br. earring* (1) with globular glass bead-pendant; „by the skull”. Two *strings of glass beads* (4,5); one consisting of light-coloured melonseed-shaped beads (4), the other of milletseed-like ones (5) in green and yellow; to judge by the position of the beads, partly around the cervical vertebrae, the strings reached down to the pelvis. Trapezoidal iron *buckle* with incurved sides (2) on the r. ilium. Two twisted iron *bracelets* (3), one on each arm.

Grave 57

(Pl. 9). D: 70; L: 230; W: 80. NW-SE. L. of skeleton: 145. M. Skull missing. Sarmatian *pottery vessel* (5) in the region of the r. shoulder; bulging bodied grey vessel with everted rim, rim-flang showing incised concentric lines; conical pedestal foot; h: 8,5; rd: 4,5; bd: 4. Small circular *silver plate* (+) „inside the r. elbow”. *Silver plate small strap-end* (2) within the pelvic area, fragments of a similar one under the former. *Fragmentary iron strike-a-light* (4) and two *flints* (6) by the r. hand. Oblong iron *buckle* (3) on the l. ilium (?). *Iron ring* (1). *Chicken bones* somewhat lower than the pelvis (?) and under the skeleton.

Grave 58

(Pl. 10). D: 90; L: 230; W: 90. NW-SE. L. of skeleton: 165. M. Maturus. Anthr. Skull in a secondary position, lying near the feet. Small *silver ring* (1). Br. *buckle* (13) with oval loop cast in one piece with its quinquangular belt-plate; within the l. pelvic cavity. Two *whetstones* (11) and two *flints* (10) between the l. ilium and l. hand. *Iron strike-a-light* (12) above (?) the former objects. Two-pronged *implement of antler* (6), perforated by a hole near its butt-end, under the bones of the r. forearm. Two oblong iron *buckles* (8, 9) from the same position. *Belt-ornaments* within the pelvic area. *Fragmentary strap-end* (5) made of two silver plates attached together with a side-band. Quadrangular *belt-mount* of silver plate (4) furnished with five rivets. „Spur-shaped” silver plate *belt-hole guard* (2). Cylindrical glass *bead* (7). Seven iron *clench-nails* for the coffin (14); by the l. foot. Two oblong narrow *mounts* of silver plate (3), perforated by three holes for the rivets. *Chicken bones* somewhat lower than the pelvis and under it.

Grave 59

(Pl. 9). D: 90; L: 220; W: 60. N-S. L. of skeleton: 170. M. Quadrangular iron *buckle* (2) and an oblong one (1) within the pelvic area.

Grave 60

D: 120; L: 150; W: 100. NW-SE. L. of skeleton: 180. M. *Silver plate fragments* „on the vertebrae”. *Pig bones* and *chicken bones* „on the knee”.

Grave 61/a

Skeleton in contracted position. No grave-goods.

Grave 61

(Pl. 9). D: 160; L: 200; W: 100. NW-SE. L. of skeleton: 185. M. Senilis. Anthr. Two penannular silver *earrings* (1) „by the skull”. *Fragmentary iron strike-a-light* (3) by the l. hand. Two iron *buckles* with incurved sides (4, 6) in the middle of the pelvis. *Iron ring* (5) on the r. caput femoris. Cylindrical bone *needle-case* (7) with turned „balls-and-ribs” decoration (three ribbed zones), near the inner side of the r. femur. Ten „spur-shaped” *belt-hole guards* of silver plate (2), lying on some remnants of leather, found somewhat higher (than the pelvis) or above it. (?) *Pig bones* on the bones of the feet.

Grave 62

(Pl. 11). D: 100; L: 190; W: 85. N-S. L. of skeleton: 164. F. Maturus. Anthr. Two large circular br. *earrings* with globular glass bead-pendants; in black; „by the skull”. Two quadrangular iron *buckles* (2) in the middle of the pelvis. Long iron *knife* under the pelvis. Biconical clay *spindle-whorl* (3), grey in colour. *Chicken bones* near the feet.

Grave 63

(Pl. 10). D: 105; L: 220; W: 85. N-S. L. of skeleton: 162. M. Maturus. Anthr. — F. Arch. Circular br. *earring* (6) with medium-sized hollow globe-pendant, „by the skull”. Small iron *chain-links* (9) on the sternum. *Iron ring* (8) from the same position. Glass *beads* (3-5) „on the lower part of the pelvis”; two spotted and some segmented beads, and two globular ones with small bosses. Small *tube of bronze* (1) among the beads. Iron *bracelet* (2; +) lying on the bones of one of the arms (?). Iron *knife* in the same position. Biconical clay *spindle-whorl* (7), red in colour, between the r. humerus and thorax. *Pottery vessel* (10) in the region of the r. knee; coarse hand-made pot in grey; h: 19,5; rd: 10,5; bd: 9,5. *Pottery vessel* (11) by the r. leg; grey hand-made pot; h: 12; rd: 10; bd: 8. *Fowl bones* somewhat lower than the pelvis (?).

Grave 64

(Pl. 11; Pl. IV. 1-5). D: 70; L: 200; W: 80. N-S. L. of skeleton: 165. M. *Belt* decorated with cast br. belt-ornaments of „Italian type”. *Buckle*: oval lop with shield-on-tongue (4), to the r. of the vertebral column and trapezoidal belt-plate furnished with four large dome-headed rivets (4), found separated to the l. of the vertebral column. Two triangle-shaped *belt-mounts* of looped type, one incomplete (2), each furnished with three large dome-headed rivets; one inside the r. arm, the other from an unknown find-spot. *Large strap-end* (1) with two large dome-headed rivets; on the l. caput femoris. Oblong iron *buckle* (5) within the pelvic area. *Iron strike-a-light* (7) by the r. hand. Iron *clench-nail* for the coffin (6) lying across the r. knee. *Fowl bones* in the region of the l. knee.

Grave 65

(Pl. 10). Db. F. NW-SE. Large circular br. *earring* (1) with blue globular bead-pendant. Biconical clay *spindle-whorl* (2), yellow in colour, decorated with stamped dots between horizontal grooves.

Grave 66

(Pl. 10). NW-SE. Ch. *Iron ring* (1). *Iron knife*. *MI* Chicken bones in the region of the feet.

Grave 67

(Pl. 11). NW-SE. F. Small *iron knife*. Irregularly shaped globoid clay *spindle-whorl* (3), grey in colour. Two fragmentary oblong *iron buckles* (2,4). Two *iron rings* (1) linked together.

Grave 68

(Pl. 11). NW-SE. Skull missing. *Iron chain* above (?) the r. shoulder. *Iron clanch-nails* for the coffin (2), about seven in number, to the r. of the cervical vertebrae.

Grave 69

(Pl. 11). NW-SE. Quadrangular *iron buckle* (1) on the chest. Biconical clay *spindle-whorl* (2), grey in colour. Long *iron knife*. *Chicken bones* in the region of the feet.

Grave 70

(Pl. 12). NW-SE. M. Maturus. Anthr. Quadrangular *iron buckle*. *Iron knife*. *Chicken bones* in the region of the r. knee.

Grave 71

(Pl. 12; Pl. III. 11-20). D: 160; L: 200; W: 90. NW-SE. M. *Mount-decorated belt*. Trapezoidal *iron buckle* (1) in the middle of the pelvis. Three quadrangular *belt-mounts* of silver plate (2), each with four dome-headed rivets, one in each corner. Silver plate *large strap-end* (10). Two oblong *belt-hole guards* of silver plate. Silver plate *propeller-shaped mount*. Oblong *mount* of silver plate (6) decorated with a circular central cell set with yellowish-green glass convex encircled with wire. Two *strap-ends* (5) made of silver plates, short and broad in shape, each with a fluted band of silver at its upper edge. Two triangular silver plate *mounts* (7), each furnished with three dome-headed rivets. *Iron strike-a-light* (8) within the pelvic area. Trapezoidal *iron buckle* (9) by the „lower edge of the pelvis”. Two *iron knives*, a small and a long one, lying close to each other, near the inner side of the l. femur.

Grave 72

(Pl. 11). D: 55; NW-SE. L. of skeleton: 150. F. Partly disturbed. Circular br. *earring* with globular black bead-pendant of small size; by the l. temple bone.

Grave 73

(Pl. 11). D: 120; L: 110; W: 60. NW-SE. Ch. Skull found in crushed condition. *Iron chain* (4) under the chin. Small globular and segmented glass *beads* (1), light- and dark-coloured ones, from the same position. Quadrangular *iron buckle* (3) on the sternum. *Iron knife* in the same position. *Pottery vessel* (5) to the r. of the pelvis; badly fired hand-made pot with vertical slashed ornament on the edge of its rim; h: 11,5; rd: 9,5; bd: 7,5. *Iron band*(2) on the sternum. *Piece of textile* from an unknown position. *Chicken bones*, *egg* and *pieces of charcoal* beside the pot.

Grave 74

(Pl. 12). D: 120; L: 220; W: 50. NW-SE. L. of skeleton: 150. F. Adultus. Anthr. Two circular br. *earrings* (1) with pendants made up of a cone-frustum type setting globular glass bead-each; „by the skull”. Biconical clay *spindle-whorl* (3) decorated with incised wavy lines; „on the waist”. Oblong *iron buckle* (2). *Egg* „in the hollow of hand”.

Grave 75

(Pl. 12). Grave-pit with projecting ledges, one at each of the long sides. D: 120; L: 200; W: 80. NW-SE. L. of skeleton: 165. M. Senilis. Anthr. *Iron knife* „in a distance of 20 cm of the skull towards the end of the grave”. Two oblong br. *mounts* (3) *hairplait-ornaments*(3); one „above the shoulder”, the other „by the skull”. D-shaped *iron buckle* (1) „on the middle of the r. arm.”. *Piece of glass* (4), *iron fragment* with br. rivet (5) and *bone object* (for polishing? 6) among the phalanges of the r. hand. Oblong (,) *iron buckle* (2) on the r. ilium. Sarmatian *pottery vessel* (7) recovered in fragments, by the r. foot; bulging bodied wheel-made bowl in grey with flaring neck decorated by a narrow ridge base with a flat foot-ring; h: 8,5; rd: 8; bd: 4,5. Fragmentary *iron fibula* (+).

Grave 76

(Pl. 12). D: 120; L: 180; W: 120. NW-SE. M. Maturus. Anthr. Cattle skeleton lying in a pit to the l. of the grave in a situation „touching the leg and waist” of the skeleton found in grave 76. Hollow-based *iron strap-ends*(1) lying across the bones of the r. forearm. *Iron buckle* with incurved sides (2), „at the edge of the r. ilium”. *Iron ring* (3) in the same position. *Disentangling hook* made of antler (4), decorated with two rows of dotted circles; „in the r. hand”. *Iron knife* „in the l. hand.” *Pottery vessel* (5) by the r. foot; coarse hand-made pot with finger-impressed rim; h: 13,5; rd: 10,5; bd: 8.

Grave 77

NW-SE. Db: only skull survived.

Grave 78

NW-SE. Db. No grave-goods.

Grave 79

(Pl. 13). D: 70. NW-SE. Ch. Two circular br. *earrings* (1) with medium-sized hollow globe-pendants; „by the skull”. Disc-shaped *spindle-whorl* (6) cut out of a grey pottery body sherd, inside the r. elbow. Two iron *armour-plates* (2) from a scale armour; under the l. ilium. Glass *beads* near the former objects; two bossed beads (3) and a small globular one in yellow (4). *Plate of lead* (5), folded up, near the inner side of the l. humerus. *Pottery vessel* (7) near the feet; hand-made blackish pot with rim missing. *Egg* „gripped by the l. hand”. *Chicken bones* on the bones of the l. arm.

Grave 80

(Pl. 13). D: 100. NW-SE. L. of skeleton: 170. M. Oblong iron *buckle* (1) on the l. ilium. Long iron *knife* by the l. femur. *Whetstone* (4) by the l. ilium. *Flint* (5) from the same position. Quadrangular iron *buckle* (8) „at the lower edge of the pelvis”. Oblong iron *buckle* (2) in the middle of the pelvis. Fragmentary iron *clench-nail* for the coffin (3) in the same position. *Disentangling hook* made of antler (7) by the r. ilium; its butt-end hollowed into trough-like socket of which decoration consists of a plain engraved double-line.

Grave 81

(Pl. 81). D: 80. NW-SE. Db. Ch. Upper part of a hand-made *pottery vessel*.

Grave 82

(Pl. 13). D: 60. NW-SE. Ch. Fragmentary br. *bracelet*, circular in section, on the bones of the l. forearm.

Grave 83

(Pl. 13; Pl. V: 15-18). D: 120; W: 80. NW-SE. L. of skeleton: 160. M. maturus. Anthr. Two br. *earrings* (1, 2), a circular and an oval one, with pendants missing; „by the skull”. Remnants of a leather „high cap” under the skull. Br. *buckle* (9) with oval loop cast in one piece with its shield-shaped belt-plate; on the l. ilium. *Large strap-end* of silver plate (10) with a narrow silver band at its upper edge; by the r. caput femoris. Two silver plate *small strap-ends* (6), short and broad in shape, each with a broad fluted silver band at its upper edge; one outside the l. ilium, the other under the pelvis, so about in the middle. Silver plate oblong-shaped *mount* (7). Fragmentary silver *rosettes* of repoussé (4) within the pelvic area; only one of them survived. Oblong iron *buckle* (8) above the br. buckle. *Flint* and fragmentary *iron strike-a-light* joined together by rust (5) in the same position. Long iron *knife* by the r. caput femoris. Two glass *beads* (2, 3) under the pelvis; one segmented bead and a black barrel-shaped one with plastic ornamentation (trailing) and „muffs” in yellow.

Grave 84

(Pl. 12). D: 90; L: 200; W: 90. NW-SE. L. of skeleton: 150. Double burial: F. Adultus. Anthr. and Ch. Babe's skeleton lying just proximal to the r. femur of the femal's. Disc-shaped *spindle-whorl* cut out of a grey pottery body-herd showing traces of red painting; „at the waist”. *Chicken bones* near the feet.

Grave 85

(Pl. 13). D: 130; L: 200; W: 70. NW-SE. F. Two circular silver *earrings* (2) with medium-sized hollow globe-pendants; one on either side of the skull. Disc-shaped thick *spindle-whorl* (3) cut out of a pottery vessel of large size, near the l. arm. Narrow-bladed iron *knife*. Oblong iron *buckle* (1). *Pottery vessel* (4) near the feet; coarse, hand-made flower-pot like vessel; h: 10,5; rd: 9; bd: 11. *Chicken bones* and *pig bones* in the region of the feet.

Grave 86

(Pl. 13). D: 110. NW-SE. Db. Ch. *Pottery vessel* „in the waist-region”; coarse hand-made pot, cylindrical in shape; h: 8,4; rd: 10; bd: 11.

Grave 87

(Pl. 14). D: 80. NW-SE. L. of skeleton: 145. Senilis. Anthr. „O-shaped leg-bones”. A small pit occurred near the skull, it had been deepened into the grave-floor, it contained *ashes*, *pieces of bronze*, an *animal bone* with smoothed surface (a tool for polishing? 5) and an *awl* made of antler. Two large circular *earrings* (1) with globular glass bead-pendants, probably with cylindrical attachment bits; „by the skull”. Biconical clay *spindle-whorl* (3) decorated with girth-grooves, by the l. hand. Quadrangular iron *buckle* (2) under the pelvis. *Pottery vessel* (6) near the feet; coarse hand-made pot, cylindrical in shape, greyish-black in colour; h: 11; rd: 8,5; bd: 7.

Grave 88

(Pl. 13). D: 45; L: 250; W: 70. NW-SE. L. of skeleton: 155. Narrow-bladed iron *knife*. *Chicken bones* „above the ankles”.

Grave 89

(Pl. 13). D: 100; L: 200; W: 70. NW-SE. L. of skeleton: 155. M. Anthr. Quadrangular iron *buckle* within the pelvic area. Narrow-bladed iron *knife* „in the l. hand”. *Chicken bones* between the knees.

Grave 90

(Pl. 13). NW-SE. Db. F. Adultus. Anthr. *Pottery vessel* near the skeleton; coars, hand-made pot; h: 16,5; rd: 12,5; bd: 9,5.

Grave 91

NW-SE. Db. No grave-goods.

Grave 92

(Pl. 14). D: 50; L: 165; W: 60. NW-SE. L. of skeleton: 115. Ch. *Pottery vessel* on the l. side of the skull; coarse hand-made pot, yellowish in colour; h: 9; rd: 7,5; bd: 4,5. *Chicken bones* in the region of the skull.

Grave 93

(Pl. 14). D: 50. NW-SE. L. of skeleton: 85. Ch. Small globular glass *beads* (1) in black, around the cervical vertebrae. Disc-shaped *spindle-whorl* (3) cut out of a grey pottery sherd. Discoidal *pottery sherd* (2) with semi-finished perforation so about in its middle (a half-manufactured spindle-whorl?). *Egg* in the region of the feet.

Grave 94

(Pl. 14). D: 100; L: 215; W: 70. NW-SE. L. of skeleton: 158. M. Maturus. Anthr. A fragmentary skull was found near the skull of the male skeleton. Remnants of a leather „high cap” under the skull. Quadrangular iron *buckle* (2) within the pelvic area. Trapezoidal iron *buckle* (1) under the l. ilium. Small iron *knife* „griped by the l. hand”. Iron *strike-a-light* (3) „in the r. hand”. *Chicken bone* on the l. of the skeleton.

Grave 95

(Pl. 14). NW-SE. Db. *Pottery vessel*: greyish hand-made pot with vertical slashed ornament on the edge of its rim; the surface of the body shows an impressed design, imitating that of woven material, formed by continous repetition of rhombi; h: 16,5; rd: 13; bd: 13.

Grave 96

NW-SE. Db. No grave-goods.

Grave 97

(Pl. 14). D: 100. NW-SE. Ch. Footbones (?) missing. Two penannular br. *earrings* (1), one „above the l. shoulder” the other inside the skull. Iron *buckle* (*iron ring* ?, 2) within the pelvic area. Iron *bracelet* (3) on the bones of the l. forearm. *Egg* „griped by the r. hand”.

Grave 98

(Pl. 14). D: 135; L: 220; W: 70. NW-SE. L. of skeleton: 175. M. Senilis. Anthr. Trapezoidal iron *buckle* (1) in the l. ilium. Narrow-bladed iron *knife* „in the r. hand”. *Pottery vessel* (2) near the feet; Cylindrical pot in yellow; h: 18,5; rd: 15; bd: 9,5.

Grave 99

(Pl. 15). D: 150; L: 220; W: 80. NW-SE. L. of skeleton: 170. M. *Flint* (5) „on the l. arm”. Quadrangular iron *buckle* (4) above (?) the pelvis. Oval iron *buckle* (1). *Iron ring* (2). Bent *iron band* (3). Broad-bladed iron *knife* „under the r. arm”. Fragmentary iron *clench-nails* for the coffin (6) bearing traces of wood.

Grave 100

NW-SE. Db. No grave-goods.

Grave 101

(Pl. 15). D: 100; L: 210; W: 70. NW-SE. L. of skeleton: 155. M. Maturus (?). Anthr. — F. (?). Arch. Iron *sickle* (1) near the l. arm. *Iron ring* (3) from the same position. Iron *knife* „on the r. arm”. Oblong (?) iron *buckle* (2) within the pelvic area. *Chicken bones* and two *eggs* in the region of the feet, an egg between the knees, a fourth one „in the hand”.

Grave 102

(Pl. 15; Pl. IV. 12-13). D: 100; L: 210; W: 70. NW-SE. L. of skeleton: 175. M. Maturus. Anthr. Three Roman br. coins (1): Constantius Gallus II (351-354), Valens (364-378) and Constantinus II (337-361); two coins occurred between the l. ilium and l. hand, the third one in the middle of the pelvis (?). *Iron strike-a-light* (8) under the latter coin. Six *flints* (5) beside the iron strike-a-light. *Iron knife* (+) „at the edge of the r. ilium”. Gilt-silver *large strap-end* of repoussé (3) decorated with interlace pattern surrounded by beading; inside the l. humerus. Shield-shaped silver *belt-mounts* of repoussé (2), plastered up with lead, decorated with „dot-and-comma” motifs; on the r. ilium and under the pelvis. *Small strap-end* with similar decoration. Oblong iron *buckle* (5) above (?) the pelvis. Three iron *clanch-nails* for the coffin (3) bearing traces of wood, within the pelvic area. *Silver plate fragments* by the r. caput femoris. „Propeller-shaped” iron *plate* (4; strap-end?) by the r. hand. Quadrangular iron *buckle* (7) by the upper part of the l. femur. *Chicken bones* to the l. of the r. arm.

Grave 103

(Pl. 15). D: 120; L: 200; W: 64. NW-SE. L. of skeleton: 155. M. Maturus. Anthr. Both arms were bent so as to rest on the pelvis. Oblong iron *buckle* (1) within the pelvic area. *Iron strike-a-light* (2) originally enclosed „in a silver riveted leather case”; by the r. hand. *Chicken bones* to the r. of the r. arm.

Grave 104

(Pl. 15). D: 120. NW-SE. Db. F. Two oval br. *earrings* (1), each with a large white bead strung on the hoop; „by the skull”. Fragmentary hollow silver *bead* (2) under the chin. Disc-shaped *spindle-whorl* (3) cut out of a pottery sherd; by the r. hand. *Pottery vessel* (4) beside the skull; coarse hand-made pot, grey in colour, with finger-impressed rim; h: 13; ht: 11,5; bd: 8,5. *Chicken bones* and some *eggs* by the r. hand.

Grave 105

(Pl. 15). D: 110; L: 220; W: 80. NW-SE. L. of skeleton: 160. F. Adultus. Anthr. Circular silver *earring* (1) with medium-sized hollow globe-pendant. *Iron knife* under the bones of the l. hand.

Grave 106

NW-SE. Db. Empty grave-pit.

Grave 107

NW-SE. Db. Empty grave-pit.

Grave 108

(Pl. 16; Pl. XVII. 1-4). D: 190; L: 190; W: 60. NW-SE. L. of skeleton: 130. F. Br. *pin* (6) under the skull. Two oval br. *earrings* (1) with dark-coloured bead-pendants of „cornless cube” type (beads missing); „by the skull”. Two circular br. *braist-clasps* (2) on the chest; they are of eight-petalled rosette type set with glass, each with a convex glass bead in the middle. Biconical clay *spindle-whorl* (8), yellow in colour, decorated with incised wavy lines; on the r. ilium (?). Two fourpartite cast br. *bracelets* (11) showing plant pattern: flat-leaf tendril with separate foliate offshoots; forward — gazing griffing on the oblong — shaped hinged clasp-bits; one on each forearm, near the elbow. Trapezoidal iron *buckle* (4). Melonseed-shaped and milletseed-like glass *beads* (7, 8). *Br. plate fragments* (3, 10). Small iron ring (9). *Chicken bones* overlapping the r. part of the skeleton.

Grave 109

(Pl. 16). D: 150; L: 200; W: 65. NW-SE. L. of the skeleton: 145. F (?). Skeleton lying with pelvis and lower limb bones turned to the r. *Flint* (1) and *iron strike-a-light* (2).

Grave 110

(Pl. 16). D: 120; L: 230; W: 60. NW-SE. L. of skeleton: 155. M. Anthr. „burnt slag” by the r. foot. *Iron strike-a-light* (3) in the region of the l. elbow. *Flint* (2) from the same position. *Iron knife* by the l. hand. Trapezoidal iron *buckle* (1) within the pelvic area.

Grave 111

(Pl. 17; Pl. XII. 1-17; Pl. XIX. 4). D: 200; L: 230; W: 80. NW-SE. L. of skeleton: 150. M. Adultus. Anthr. *Mount-decorated belt*. Trapezoidal br. *buckle* (2) with belt-plate made of br. sheet furnished with three large-domed rivets. Cast br. *large strap-end* (14) showing fleur-de-lis motifs in openwork; socketed strap-fastener fitted with two projections for the rivets. Two cast br. openwork *small strap-ends* (4) decorated with plant pattern of foliate type; type of the strap-fastener: socket fitted with two projecting bird heads facing each other. Nine cast br. *belt-mounts* with hinged pendants (12): shield-shaped openwork upper parts bearing plant pattern of „scroll-and-blossom” type and shield-shaped pendants, openwork in the middle (two pendants missing). Cast br. *propeller-shaped mount* (5). Belt-loop (8) made of br. plate. Four cast br. *belt-hole guards* (9) in shape of a crescent, openwork in the middle. Four *belt-mounts* of br. plate (10), longish in shape, one edge lobed; each with large dome-headed rivets. Bent br. *wire* (6) presenting the form of a rhombus. Cast br. quinquangular attachment *mount* with hanging ring (15). Oblong iron *buckle* (3). Oval iron *hoop* (7);

belt-loop? /or an iron strike-a-light?). Two *flints* (13). Iron *knife*. Two br. *finger-rings* (1), each hoop fitted with three small projecting pyramids made up of granules; on the annular finger of the r. hand. *Pottery vessel* (16) on the r. side of the skull; hand-made pot decorated with wavy and horizontal zones of incised lines; h: 13,5; rd: 11,5; bd: 8. *Fowl bones* „between the l. hand and foot”. Larger *piece of leather* „by the hand”.

Grave 112

(Pl. 16). D: 200. NW-SE. F. Senilis. Anthr. „Trepanation on the skull”. The skeletal bones lay „irregularly” but other phenomena suggesting disturbances were not observed. Two oval br. *earrings* (1) with small drop-shaped glass bead-pendants, dark blue in colour. Black melonseed-shaped glass *bead* of striped type (4). Two br. *bracelets* (2) circular in section, with slightly thickened terminals. Iron *knife*. Iron *fragments* (2; awl?).

Grave 113

(Pl. 16). D: 100; L: 200; W: 60. NW-SE. L. of skeleton: 165. M. Maturus. Anthr. Skull found facing to the r. Iron *knife* „above the r. shoulder”.

Grave 114

(Pl. 16). D: 185; L: 200; W: 60. NW-SE. L. of skeleton: 155. F. Two oval br. *earrings* (1) with glass bead-pendants in light blue (?); „by the skull”. Black and light-coloured melonseed-shaped glass *beads* (3). Oblong iron *buckle* (2) on the r. ilium. *Pig bones* and *chicken bones* near the inner side of the bones of the r. arm.

Grave 115

(Pl. 16). D: 180; L: 200; W: 70. NW-SE. L. of skeleton: 160. M. Mat. Anthr. „Head and trunk turned to the left”. Two iron *knives*, one within the pelvic area, the other in the region of the r. elbow. *Egg* to the l. of the skeleton. *Chicken bones* under the pelvis.

Grave 116

(Pl. 17; Pl. XV. 1-3). D: 150; L: 180; W: 60. NW-SE. L. of skeleton: 100. Ch. Penannular silver *earring* (1) „by the skull”. Iron *chain-links* (4) under the chin. Glass *beads* (6) around the cervical vertebrae; light-coloured melonseed-shaped beads, yellow milletseed-like ones and segmented beads in yellow. Iron *knife* within the pelvic area. Quadrangular iron *buckle* (5; +). Oblong-shaped bone *purse-fastener* (3) decorated with dotted circles; on the l. ilium. *Stick head* of bone (7) on the sternum. Narrow *bone plate* (2) with two circular perforations on its 8-shaped end; decoration: a vertical row of engraved circles; on the sternum. *Pottery vessel* in the region of the r. knee; coarse hand-made pot, blackish in colour; h: 11,5; rd: 9,5; bd: 8,5. *Egg* by the r. hand.

Grave 117

(Pl. 16). D: 170; L: 220; W: 80. NW-SE. L. of skeleton: 150. F. Skull found tilting to its r. side. Two circular br. *earrings* (1) with large globular glass bead-pendants in blue; „by the skull”. Iron *knife* by the l. humerus. Disc-shaped *spindle-whorl* (5) cut out of a grey pottery sherd; „in the r. hand”. Oblong iron *buckle* (3) within the pelvic area. Iron *ring* (4) under the l. femur. Glass *beads* in small quantity, only a light-coloured segmented bead (2) survived. *Chicken bones* by the l. humerus.

Grave 118

D: 100; L: 100; W: 50. NW-SE. L. of skeleton: 60. Ch. No grave-goods.

Grave 119

NW-SE. Db. No grave-goods.

Grave 120

(Pl. 18). D: 120; L: 130; W: 70. NW-SE. L. of skeleton: 60. Ch. Quadrangular iron *buckle* (2) within the pelvic area. Fragmentary iron *bracelet* (1).

Grave 121

D: 70; L: 100; W: 60. NW-SE. L. of skeleton: 60. Ch. No grave-goods.

Grave 122

D: 65; L: 100; W: 50. NW-SE. L. of skeleton: 50. Ch. No grave-goods.

Grave 123

D: 100; L: 140; W: 60. NW-SE. L. of skeleton: 90. Ch. No grave-goods.

Grave 124

(Pl. 18; Pl. XI. 1-12). D: 190; L: 200; W: 80. NW-SE. L. of skeleton: 170. M. Adultus. Anthr. Two penannular silver earrings (1), one on either side of the skull. *Mount-decorated belt*. Cast br. hinged buckle (9) consisting of an oval loop and belt-plate decorated with plant pattern in openwork. Cast br. large strap-end (8) showing plant pattern of multiflorous type in openwork inside a border-design consisting of wavy lines and beading-like pattern socketed strap-fastener fitted with two projections for the rivets. Four cast br. small strap-ends (7) decorated with plant pattern of foliate tendril type in openwork; type of the strap-fastener: socket fitted with two projections for the rivets. Five cast br. belt-mounts with hinged pendants (6): shield-shaped upper parts and pendants decorated with foliate design in openwork. Similar mount (5) without pendant. Cast br. propeller-shaped mount (10) showing scalloped border. Four cast br. belt-hole guards (4) with plant pattern of multiflorous type. Nine cast br. mounts for the pendent straps (3), decorated with stylized leaf-motifs in openwork. Belt-loop (2) fashioned from br. plate; plant pattern on the surface of the covering plate of cast br. Two iron knives lying across the r. femur. Quadrangular iron buckle (11) beside the br. buckle. Iron ring (12) under the pelvis. Two eggs, one „on the hand”, the other on the chest.

Grave 125

(Pl. 18). D: 110; L: 200; W: 80. NW-SE. L. of skeleton: 160. M. Maturus. Anthr. Long iron knife by the l. hand. Chicken bones in the region of the skull.

Grave 126

(Pl. 18). D: 130; L: 280; W: 80. NW-SE. L. of skeleton: 160. M. Quadrangular iron buckle.

Grave 127

(Pl. 18). D: 170; L: 260; W: 80. NW-SE. L. of skeleton: 165. M (?). Trapezoidal iron buckle (2) to the r. of the l. hand. Iron knife near the l. leg bones. Pottery vessel (1) to the l. of the skull; coarse hand-made pot, blackish in colour, with finger-impressed rim-edge; h: 12; rd: 8; bd: 5,5.

Grave 128

(Pl. 20). D: 100; L: 120; W: 50. NW-SE. L. of skeleton: 90. Ch. Light-coloured and black melonseed-shaped glass beads (1) and segmented ones (2).

Grave 129

D: 100; L: 160; W: 50. NW-SE. Ch. Fragmentary skull, skeletal bones in decayed condition. Fowl bones near the r. hand.

Grave 130

(Pl. 19; Pl. IX. 1-15; Pl. XVIII. 7). D: 240; L: 310; W: 115. NW-SE. L. of skeleton: 165. M. Adultus. Anthr. The grave-pit was longer and deeper than in general for adult graves as a whole. Decayed skeletal remains recovered in saturated soil, skull found in a slightly tilted position. The corpse had been wrapped in leather of which traces were detectable on the skeletal bones. Pottery vessel (10) by the l. humerus; wheel-made yellow bottle with a broad horizontal fluting along its belly; painted decoration: wild-boar heads depicted in medaillon forms (black, dotted in white), and geometrical motifs in each field between the individual medaillons; h: 17,5; rd: 6,3; bd: 8. *Mount-decorated belt*. Cast br. hinged buckle (4) consisting of an oval loop and belt-plate decorated with flat-leaf tendril; in the middle of the pelvis. Oval cast br. buckle (2) of „winged” type, beside the hinged buckle. Cast br. double-plate large strap-end (7) decorated with flat-leaf tendril; each panel with two projecting strap-fasteners in form of confronted animal heads; by the l. femur. Four cast br. double-plate small strap-ends (6) showing flat-leaf tendril decoration; each panel with two projecting strap-fasteners in form of confronted animal heads. Twelve cast br. belt-mounts with hinged pendants (8); elongated shield-shaped upper parts decorated with flat-leaf tendril of S-type and shield-shaped pendants with scale-like pattern; the mounts were found lying „in the direction of the belt”. Three similar mounts but without pendants (8). Three plain shield-shaped belt-hole guards of cast br. (3); „from the belt”. Twenty-four plain shield-shaped cast br. mounts for the pendent straps (1). Cast br. propeller-shaped mount (5) on the bones of the r. leg; „in the same direction as the belt”. Belt-loop (9) made of br. plate to the l. of the buckles. Iron knife by the r. foot (?). Fowl bone within the pelvic area.

Grave 131

D: 90. NW-SE. M. Maturus. Anthr. Db: the „lower part” of the skeleton had been destroyed during digging a trench before the excavation started. Skeleton lying with forearms crossed and hands „clasped” under the chin. No grave-goods.

Grave 132

(Pl. 20). D: 100; L: 220; W: 70. NW-SE. L. of skeleton: 150. F (?). Fragmentary skull. Trapezoidal iron buckle.

Grave 133

D: 50; L: 150; W: 70. NW-SE. L. of skeleton: 135. Ch. No grave-goods.

Grave 134

(Pl. 20). D: 50; L: 120; W: 60. NW-SE. L. of skeleton: 70. Ch. Globular white glass *bead* (+).

Grave 135

(Pl. 20). D: 155; L: 170; W: 70. NW-SE. L. of skeleton: 110. Ch. Oval br. *earring* (1) with glass bead-pendant missing. Two circular *braist-clasps* (3); one of them, a br. specimen, is of eight-petalled rosette type with green glass inlay, the other, a gilt-bronze one, is a four-petalled type with green inlay in the „petals” and with blue glass in the cells, concave triangles in shape, arranged between the individual „petals”. Biconical clay *spindle-whorl* (5), grey in color. Cylindrical bone *needle-case* (4) beside the skull. Iron *knife*. Two *eggs*, one on either side of the skull. *Chicken bones* „gripped by the l. hand”.

Grave 136

(Pl. 20; Pl. XVI. 4). D: 170; L: 230; W: 100. NW-SE. L. of skeleton: 160. F. Adultus. Anthr. Glass *beads* (1-2) of various types: black cylindrical beads with relief-trails in yellow, disc-shaped ones, milletseed-like beads and dark-coloured melonseed-shaped ones (1), one barrel-shaped black bead of larger size, dotted in white (2). Fragment of a hollow silver *bead* (4). Strogly worn clay *spindle-whorl* (3) in shape an oblate spheroid, grey in colour.

Grave 137

D: 210; L: 220; W: 90. NW-SE. F. (?). Db. *Egg* in one of the corners of the grave-pit.

Grave 138

(Pl. 20). D: 170; L: 280; W: 70. NW-SE. Db. M. Iron *knife* „under the r. arm”.

Grave 139

(Pl. 19; Pl. IX. 16-24). D: 160; L: 200; W: 90. NW-SE. M. Db: upper part of the skeleton found disturbed, skull in a secondary position, a half meter higher than the skeletal bones. Twenty-one *belt-ornaments* cast of lead; they occurred „scattered” in the grave-filling. Double-plate openwork large strap-end (6); decoration: plant pattern, inside a rope-like border, consisting of tendrils depicted „back to back” and set in pairs; each panel with two projecting strap-fasteners in form of two confronting animal heads. Two double-plate openwork *small strap-ends* (3) showing plant pattern like fleur-de-lis motif; each panel with two projecting strap-fasteners. Seven *belt-mounts* with hinged pendants (4): shield-shaped upper parts decorated with lily-like plant pattern in openwork and oblong „frame-type” pendants (one pendant missing). Three openwork *belt-hole guards* (2) showing plant pattern. Seven shield-shaped *mounts for the pendent straps* (1), radially ribbed. *Propeller-shaped mount* (5) bordered by a plain raised line. Oblong (?) iron *buckle* (7). Broad-bladed iron *knife*.

Grave 140

(Pl. 20; Pl. VIII. 10-16). D: 160; L: 220; W: 70. NW-SE. L. of skeleton: 165. M. *Mount-decorated belt*; no informations about position of the belt-ornaments. Four cast br. double-plate *small strap-ends* (2) decorated with flat-leaf tendrils in openwork; each panel with two projecting strap-fasteners in form of confronted animal heads. Cast br. hinged *buckle* (4) consisting of an oval loop and plain shield-shaped belt-plate. Plain *propeller-shaped mount* (5) cast in br. Five cast br. shield-shaped *belt-mounts* (6) with pearled border, openwork in the middle. Thirteen cast br. *belt-mounts* with hinged pendants (7): elongated shield-shaped upper parts with pearled border, openwork in the middle, and shield-shaped pendants of small size. Five cast br. *mounts for the pendent straps* (1). Shield-like in shape, without decoration. Two plain shield-shaped *belt-hole guards* of cast br. (8). Iron *belt-loop* (3). Long iron *knife* by the r. hand. *Egg* and *chicken bones* in large quantity; under the pelvis.

Grave 141

(Pl. 20). D: 180; L: 230; W: 80. NW-SE. F. Adultus. Anthr. Db: Upper part of the skeleton. Two br. *bracelets* (2) with slightly thickened terminals, circular in section; one on each forearm. Five small globular glass *beads* (1) in the region of the cervical vertebrae.

Grave 142

(Pl. 20). D: 150; L: 260; W: 80. NW-SE. L. of skeleton: 160. F. Adultus. Anthr. Oval br. *earring* (1) with drop-shaped glass bead-pendant; „by the skull”. Biconical clay *spindle whorl* (3), grey in colour, above (?) the pelvis. Cylindrical bone *needle-case* (4) with turned „ball-and-ribs” decoration; within the pelvic area. Iron *needle* enclosed in the needle-case. Glass *beads* of various types on the l. part of the chest; blue melonseed-shaped beads, cylindrical and globular ones, polyhedral beads in white and one iridescent brick-shaped bead of larger size. *Pig bones* on the l. part of the chest.

Grave 143

(Pl. 21; Pl. XVIII. 1-2). D: 230; L: 230; W: 90. NW-SE. L. of skeleton: 180. M. Fragments of iron *clench-nails* for the coffin (3), originally six or seven in number, occurring at different levels of the grave-filling from a depth of 50-60 cm. Quadrangular iron *buckle* (2) within the pelvic area. Oval iron *buckle* (4) to the r. of the former buckle. Socketed cast br. *strap-end* (6) decorated with six tendrils depicted „back to back” and set in pairs; „by the l. arm”. *Belt-loop* (5) fashioned from br. band bordered with plain ribs; somewhat higher than the strap-end. Small *propeller-shaped mount* (+)

„under the r. arm”. Fragments of an iron *knife* from an unknown position. Two *iron rings* linked together (1). Quadrangular br. *belt-mount* (9; +) with four rivets, one in each corner. *Pottery vessel* (8) near the feet; wheel-made *jar* with bulging body, terracotta in colour, with handle missing, a collar in several degrees below its lip; h: 21; rd: 6,8; bd: 8. *Pottery vessel* (7) in the region of the r. knee; wheel-made yellowish-red *mug* with handle; h: 14; rd: 8,6; bd: 8,5. *Chicken bones* near the feet.

Grave 144

(Pl. 20). D: 80. NW-SE. Ch. Light-coloured melonseed-shaped and cylindrical glass *beads* (2). Iron *chain-links* (1) among the beads.

Grave 145

(Pl. 21). D: 230. NW-SE. M. Db: badly disturbed grave, skull found facing downwards; traces of br. patina on the ilia. Two iron *knives* on the l. of the skeleton. Cast br. *belt-mount* with hinged pendant missing (1): elongated shield-shaped upper part decorated with engraved palmette-like motifs against a punched background; among the disturbed pelvic bones. Two cast br. *belt-hole guards* (2), shield-like in shape, showing engraved plant pattern against a punched background; in the same position. Iron *clench-nails* for the coffin (3); one in each corner of the grave-pit and one specimen near the grave-wall, so about in the middle.

Grave 146

(Pl. 20). NW-SE. Db. while digging out a tree. Ch. Light-coloured melonseed-shaped glass *bead* (2). Fragmentary biconical clay *spindle-whorl* (1) in grey.

Grave 147

D: 90; L: 130; W: 50. NW-SE. L. of skeleton: 70. No grave-goods.

Grave 148

(Pl. 21; Pl. XVIII. 5). D: 200; L: 200; W: 70. NW-SE. Double burial: F. and Ch. Babe's skeleton lying on the bones of the r. arm of the femal's. L. of skeleton: 140. Glass *beads* on the chest; dark and light-coloured melonseed-shaped beads, globular and segmented ones, some black cylindrical beads with white plastic ornamentation (trailing) and „muffs” in yellow, and one longish pentagonal bead. *Pottery vessel* (1) outside the l. knee; wheel-made yellow *mug* with handle, body bulging in its lower part; black painting on the surface: it is divided up into fields by horizontal and vertical stripes, a plant ornament in each of the fields; h: 11,3; rd: 6,3; bd: 4. *Chicken bones* near the feet.

Grave 149

(Pl. 22). D: 100; L: 170; W: 90-70. NW-SE. L. of skeleton: 150. F. Adultus. Anthr. Skull found tilting to its r. side. Two oval br. *earrings* (1) „by the skull”; one earring with globular glass bead-pendant, the other with similar pendant, blackish in colour. Two iron *bracelets* (4), circular in section, with slightly thickened terminals; one on each forearm. String of glass *beads* (3) consisting of various types; black barrel-shaped beads with relief-trailing in yellow, some of them with yellow „muffs”, one black globular bead bossed in yellow, a melonseed-shaped one in blue; around the cervical vertebrae. Biconical clay *spindle-whorl* (5), grey in colour, within the pelvic area. Fragmentary oblong (?) iron *buckle* (2). Two globular glass *beads* in yellow (5). *Chicken bones* by the r. foot.

Grave 150

(Pl. 20). D: 210; L: 150; W: 70. NW-SE. L. of skeleton: 140. F (?). Db: skull and bones of the region of the shoulders were found in a disturbed position. Fragments of a penannular br. *ring* (3) under the r. scapula. Two-pronged *implement of antler* (2; one „fork” incomplete), perforated with a hole near its butt-end; on the l. humerus. Fragmentary iron *needle* (1).

Grave 151

(Pl. 20). D: 140; L: 150; W: 80. NW-SE. L. of skeleton: 100. Ch. *Egg* and *chicken bones* in the region of the r. knee. *Pig bones* neat the feet. Fragmentary *iron knife* in the disturbed grave-filling.

Grave 152

(Pl. 23; Pl. VII. 1-12; Pl. XVIII. 4). D: 160; L: 230; W: 85. NW-SE. L. of skeleton: 155. F. Maturus. Anthr. — M. Asch. Two iron *clench-nails* from the coffin (12) in the grave-filling (?); one in line with the feet; the other in line with the skull, near the l. wall of the pit. *Mount-decorated belt*. Cast br. hinged *buckle* (13) consisting of an oval loop and belt-plate decorated with flat-leaf tendril. Cast br. double-plate large *strap-end* (4); decoration: flat-leaf tendril inside a scalloped border; each panel with projecting strap-fasteners in form of two confronted animal heads. Cast br. double-plate *small strap-ends* (3), four in number, showing S-shaped tendrils; each panel with two projecting strap-fasteners in form of confronted animal heads. Six cast br. *belt-mounts* with hinged pendants (2); shield-shaped upper parts decorated with foliate pattern in openwork and openwork shield-shaped pendants; two mounts with pendants missing. Similar *mount* with ring-pendant (1) and two ones without pendants (8). Four cast br. *belt-hole guards* (5) showing plant pattern in openwork. Twenty-five shield-shaped cast br. *mounts for the pendent straps* (7), each with an engraved palmette against a punched background. *Belt-loop* (9) made of br. plate; front-plate decorated with engraved plant pattern of „foliate-florous scroll” type, with large lobed leaves, against a punched background. Cast br. *propeller-shaped mount* (10). Cast br. hinged

buckle (11) consisting of an oval loop and plain belt-plate. Iron *knife* bearing remnants of a wooden sheath. *Pottery vessel* (13) near the feet; funnel-necked wheel-made *bottle*, with body bulging in its lower part, in yellow with traces of black painting on its surface; h: 16; rd: 4,5; bd: 5,5. *Pig bones* from an unknown find-spot.

Grave 153

(Pl. 22). Grave-pit with projecting ledges, one at each of the long sides. D: 170; L: 200; W: 130-70. NW-SE. L. of skeleton: 130. F. Skeleton lying on its r. side; a layer of „black earth”, 60 cm in thickness, under the skeleton (settling as the result of underground water?). Two oval br. *earrings* (1) with glass bead-pendants missing; „by the skull”. Glass *beads* (3) around the cervical vertebrae; black cylindrical beads with relief trailing in yellow, some of them with „muffs” in the same colour. Two iron *bracelets* (2) within the pelvic area. *Chicken bones* within the pelvic area; Six *eggs*, five of them of large size; some eggs on the skull, the others „on the shoulders” and on the chest.

Grave 154

(Pl. 22). D: 190; L: 200; W: 90. NW-SE. L. of skeleton: 145. F. Adultus. Anthr. *Beads* (2): black melonseed-shaped glass beads of striped type and prismatic ones of similar material and some polyhedral cornelian beads; around the cervical vertebrae. Two br. *bracelets* (4), circular in section, with slightly thickened terminals; one on each arm. Quadrangular iron *buckle* (2) within the pelvic area. Cylindrical bone *needle-case* (1) with turned „ball-and-ribs” decoration; within the pelvic area. biconical clay *spindle-whorl*, grey in colour, decorated with girth-grooves; within the pelvic area. *Pig bones* in large quantity, to the r. of the skull.

Grave 155

(Pl. 20). D: 130; L: 140; W: 60. NW-SE. L. of skeleton: 100. Ch. Iron *knife* by the r. hand.

Grave 156

(Pl. 22). D: 120; L: 160; W: 60. NW-SE. L. of skeleton: 100. F. Two oval *earrings* (1) with truncopyramidal glass bead-pendants in green; one on either side of the skull. Glass *beads* (2): black cylindrical beads with plastic ornamentation, some of them with „muffs”, in yellow, and light-coloured melonseed-shaped ones. Biconical clay *spindle-whorl* (3), grey in colour. *Pieces of textile* within the pelvic area. *Pig bones* somewhat lower than the pelvis (?).

Grave 157

(Pl. 22). D: 110; L: 160; W: 60. NW-SE. L. of skeleton: 120. F (?). Iron *knife* under the bones of the r. hand. *Chicken bones* near the feet.

Grave 158

(Pl. 22). NW-SE. F. Db. Biconical clay *spindle-whorl*, grey in colour, among the disturbed bones of the skeleton.

Grave 159

D: 60. NW-SE. Babe. No grave-goods.

Grave 160

(Pl. 226). D: 90; L: 200; W: 60. NW-SE. L. of skeleton: 165. Oblong iron *buckle*.

Grave 161

(Pl. 22). D: 180; L: 200; W: 80. NW-SE. L. of skeleton: 140. F. Db: skull and „bones of the shoulders” found in a disturbed position: the deceased had been deposited with legs laid closely side by side and l. arm laid across lower abdomen. *Chicken bones* on the feet (?). Glass *beads* (1) along the bones of the l. arm; light-coloured melonseed-shaped beads; segmented and milletseed-like ones, black cylindrical and globular beads with plastic ornamentation (trailing, some of them with small bosses) in yellow. Small iron *chain-links* (3) under the r. scapula. Two br. *bracelets* (2), rectangular in section; one on the l. arm, the other above (?) the bones of the r. hand.

Grave 162

D: 140; L: 175; W: 80. NW-SE. L. of skeleton: 160. M (?). The deceased had been deposited with r. leg flexed and drawn up; bones of the l. arm were found „outstretched”. No grave-goods. The grave was found above a round prehistorical dwelling pit containing pottery sherds, animal bones and snailhorns but no any ashes; dm: 180; d: 190.

Grave 163

(Pl. 22). D: 170; L: 200; W: 80. NW-SE. L. of skeleton: 140. F. Maturus. Anthr. Skeleton lying with „r. arm on the chest”, bones of the l. hand within the pelvic area, skull found tilting to its l. side. Biconical clay *spindle-whorl*, grey in colour, decorated with incised horizontal and zigzag lines; to the r. of the pelvis (?). „Sherds of cloth”.

Grave 164

(Pl. 22). D: 190; L: 210; W: 70. NW-SE. L. of skeleton: 160. F (?). Skull facing to the r. Iron *knife* inside the r. elbow.

Grave 165

D: 100; L: 180; W: 70. NW-SE. L. of skeleton: 150. M. Maturus. Anthr. No grave-goods.

Grave 166

D: 90; L: 170; W: 70. NW-SE. L. of skeleton: 130. F (?). No grave-goods.

Grave 167

(Pl. 22). D: 80; L: 200; W: 60. NW-SE. L. of skeleton: 160. F. Quadrangular br. *buckle* (1) with iron tongue missing. Iron *knife* „in the l. hand”. Rectangular iron *buckle* (2). *Chicken bones* on the bones of the feet and on the chest.

Grave 168

(Pl. 23; Pl. VI. 7). D: 90; L: 230; W: 60. NW-SE. L. of skeleton: 165. Skull found tilting to its l. side. Oblong iron *buckle* (2) under the l. ilium. Quadrangular iron *buckle* (3) above the l. ilium. Socketed *small strap-end* of cast br. (1) under the buckle; one of its surfaces decorated with tenrils, lyre and S in shape, the other with a crouched griffin. *Chicken bones* near the feet.

Grave 169

(Pl. 24; Pl. XVIII. 3). D: 120; L: 240; W: 70. NW-SE. L. of skeleton: 160. F. Maturus. Anthr. Br. *earring* (2; +); br. staining on the skull. Four black barrel-shaped glass *beads* with yellow relief trails; three beads were found around the cervical vertebrae, one occurred within the pelvic area. Biconical clay *spindle-whorl* (3), red in colour, decorated with girth-grooves; a worn specimen; to the r. of the skull. Fragmentary iron *clench-nail* for the coffin (5) by the r. foot. *Pottery vessel* (6) on the r. side of the skull; wheel-made yellow *mug* with handle, its surface shows traces of black painting. Br. *band* (4) with margins of plain engraved lines. *Chicken bones* and *pig bones* in large quantity, on both sides of the skeleton; skull of a carnivorous small animal among the other animal bones.

Grave 170

D: 200; L: 240; W: 70. NW-SE. L. of skeleton: 145. M. Adultus. Anthr. Skull found tilting to its l. side. Iron *knife* „in the r. hand”. *Chicken bones* on the r. part of the chest; *pig bones* in the region of the feet.

Grave 171

D: 90; L: 210; W: 80. NW-SE. L. of skeleton: 145. F (?). Skull found in fragmented condition. No grave-goods.

Grave 172

(Pl. 23). D: 100; L: 210; W: 80. NW-SE. L. of skeleton: 150. F. Senilis. Anthr. Skeleton lying with legbones wide apart. Iron *knife*. Br. *fragment* (1) in the grave-filling. *Chicken bones* in the region of the feet.

Grave 173

(Pl. 23). D: 150; L: 200; W: 70. NW-SE. L. of skeleton: 150. F. Maturus. Anthr. *Beads* (2) „on the l. shoulder”; globular glass beads and a cornelian one, polyhedral in shape. Cylindrical bone *needle-case* (1) with turned „ball-and ribs” decoration; on the l. ilium (?); iron *needle* enclosed in the needle-case.

Grave 174

(Pl. 23). D: 150; L: 240; W: 100. NW-SE. L. of skeleton: 170. M. Senilis. Anthr. Iron *knife* under the skeleton. *Chicken bones* within the pelvic area. *Egg* in the region of the l. knee.

Grave 175

(Pl. 23; Pl. XVI. 5). D: 200; L: 230; W: 87. NW-SE. L. of skeleton: 140. F. „The skeleton had been pored over by some kind of liquid”; only the bones of the legs could be rescued. Oval br. *earring*(1) with glass bead-pendant missing. Glass *beads* (2-3): six segmented beads, a white discoid one, black cylindrical beads with plastic ornamentation (trailing) and „muffs” in yellow (2) and one barrel-shaped „eyespot-bead” in blue-white (3).

Grave 176

(Pl. 24). D: 180; L: 210; W: 70. NW-SE. L. of skeleton: 145. F. Maturus. Anthr. Strongly worn biconical clay *spindle-whorl* (4), grey in colour; within the pelvic area. *Beads* (2) in the region of the l. shoulder; one polyhedral cornelian bead and glass beads of various types: three black barrel-shaped beads with yellow relief-trailing, one light-coloured melonseed-shaped bead, seven segmented ones, one cylindrical and one globular bead. Two fragments of a *cockle-shell* (3). Fragmentary br. *needle* (1) on the l. part of the chest. *Chicken bones* in large quantity and an egg „by the leg”. *Pig bones* somewhat lower than the pelvis (?).

Grave 177

(Pl. 23). D: 190; L: 190; W: 80. NW-SE. F (?). „Skull turned back”. Fragmentary iron *clench-nail*(1). Iron *knife*. *Egg* between the knees.

Grave 178

D: 100; : 150; W: 55. NW-SE. L. of skeleton: 110. Ch. *Egg* near the skull. *Chicken bones* near the feet.

Grave 179

(Pl. 24; Pl. V. 8-14). D: 150; L: 230; W: 80. E-W. L. of skeleton: 170. M. Two penannular silver *earrings*(1) „by the skull”. *Mount-decorated belt*. Oval br. *buckle* (3). *Large strap-end* (5), broad-shaped, made of two silver plates attached together with a side-band. Three silver plate *small strap-ends* (8), each with a fluted silver band at its upper edge. Three circular *mounts* of silver plate (2), with surface slightly convex, each bordered with a plain raised line. Quadrangular iron *buckle* (4) under the sacrum. Long iron *knife* originally enclosed in a wooden sheath; two silver plate „strap-ends”, each with a fluted silver band at its upper edge, one on either side of the knife-tang. *Disentangling hook* made of antler (6) „on the edge” of the r. ilium.

Grave 180

(Pl. 25-26; Pl. I-II. 1-7). D: 230; L: 250; W: 80. N-S. L. of skeleton: 180. M. Adultus. Anthr. Circular silver *earring* (6) with medium-sized hollow globe-pendant. Straight, two-edged iron *sword* (5) without sword-guard; on the l. of the skeleton, „from the shoulder down to the knee”. Long iron *knife* and iron *awl* joined together by rust; under the sword. Three *flints* (8) beside the sword-tang. Two trilateral iron *arrowheads* (16) under the points of the sword-blade. *Bone fittings for a bow* (Pl. 26), stiffeners from the *terminals* and plates from the *grip*; they were found lying on the l. part of the chest and across the l. knee. Iron *strike-a-light* (6). Two oblong iron *buckles* (9-10), one above the pelvis, the other under it. *Belt* decorated with repoussé silver ornaments plastered up with lead; some of the ornaments fell into tiny pieces on being lifted. Double-plate *large strap-end* (12) with back-plate made of br.; front-plate decorated in repoussé (only central part survived). Seven *belt-mounts* (2) „double-shield” in shape; decoration: „dot-and-comma” motif on both sides if a central lyriiform motif. Eight *small strap-ends*(14) bearing similar decoration. Iron *strap-end* (13); attached to it is a piece of textile. Trapezoidal br. *buckle* (1) cast in one piece with its belt-plate showing tendril-decoration in openwork. S-shaped br. *chain-link* (3). Oblong br. *plate* (14) with rivets, one in each corner. Roman *knee-brooch* (7) with pin missing. Four Roman br. coins; only one coin (17) has survived: Constantin II. *Bone plate* (15) in shape of three discs linked with one another, each disc is perforated through the centre; traces of iron rust inside one of the holes. *Pottery vessel* (18) by the r. foot; hand-made wide-mouthed pot in grey; h: 14,5; rd: 13; bd: 9. *Chicken bones* in large quantity and some *pig bones*; in the region of the r. shoulder and beside the skull.

Grave 181

(Pl. 24). D: 130; L: 200; W: 70. NW-SE. L. of skeleton: 160. F. „the skeleton had been poured over by some kind of liquid”. Iron *knife* by the r. hand. Iron *clench-nail* for the coffin (1) „on the elbow”. *Egg* under the pelvis.

Grave 182

D: 200; L: 240; W: 90. NW-SE. L. of skeleton: 160. M. (?) No grave-goods.

Grave 183

(Pl. 24). D: 140; L: 240; W: 80. NW-SE. L. of skeleton: 150. Double burial: F. Adultus Anthr. and Ch. Arms of the femal were bent so as to rest on the thighs. Babe's skeleton lying on the legbones of the femal's, with its skull pointing in the opposite direction to that of the femal. Biconical clay *spindle-whorl*, grey in colour, under the pelvis. *Egg* under the skull. *Chicken bones* behind the skull.

Grave 184

(Pl. 24). D: 120; L: 220; W: 70. NW-SE. L. of skeleton: 155. F. Maturus. Anthr. Arms were bent so as to rest on the pelvis. Oval iron *buckle* (+) „on the l. shoulder”. Iron *strike-a-light* (2; +) from the same position. *Flint* (3) on the r. ilium. Iron *buckle* (4). *Chicken bones* on the chest. *Egg* and *chicken bones* between the feet (?).

Grave 185

D: 110; L: 220; W: 60. NW-SE. L. of skeleton: 140. M. Maturus. Anthr. „The skeleton had been poured over by some kind of liquid; only small pieces of the skeletal bones survived”. Bones of the forearms within the pelvic area. No grave-goods.

Grave 186

D: 110; L: 220; W: 80. NW-SE. L. of skeleton: 160. F (?). „The skeleton had been poured over by some kind of liquid”; bones of the forearms within the pelvic area. No grave-goods.

Grave 187

D: 60. NW-SE. Babe. No grave-goods.

Grave 188

D: 70; L: 200; W: 70. L. of skeleton: 140. F. Maturus. Anthr. Skull found tilting to its l. side. No grave-goods.

Grave 189

D: 140; L: 90; W: 60. NW-SE. L. of skeleton: 155. F. Maturus. Anthr. No grave-goods.

Grave 190

(Pl. 24). D: 150; L: 210; W: 90. NW-SE. L. of skeleton: 140. F. Iron *knife* under the bones of the r. hand. *Chicken bones*, on the r. knee". Three *fireplaces*: pits containing ashes, were observed in this area of the cemetery; the pits, 150 cm in width, occurred near each other.

Grave 191

D: 130. NW-SE. L. of skeleton: 70. Ch. No grave-goods.

Grave 192

(Pl. 24). D: 90; L: 200; W: 70. NW-SE. L. of skeleton: 140. F (?). Iron *knife* on the chest. *Skull of a dog* and „*burnt bones*”.

Grave 193

D: 80; L: 200; W: 70. NW-SE. L. of skeleton: 140. F (?). No grave-goods.

Grave 194

D: 140; L: 200; W: 60. NW-SW. L. of the skeleton: 140. F (?). *Chicken bones* and *pig bones* to the r. of the skull. *Mandible of a dog* on the l. part of the chest.

Grave 195

(Pl. 24). D: 160; L: 220; W: 70. NW-SE. L. of skeleton: 160. M. Maturus. Anthr. Skeletal bones in fair condition. Long iron *knife* on the r. of the skeleton. Two quadrangular iron *buckles* (1, 2), one of them recovered in fragments, within the pelvic area.

Grave 196

(Pl. 24). D: 90; L: 200; W: 70. NW-SE. L. of skeleton: 155. F (?). Iron *knife* deposited on the l. arm. „*Burnt bones*” on the chest.

Grave 197

NW-SE. Ch. Db: during digging out a tree. No grave-goods. Six *pits*, 160 cm in depth and 170 cm in width, were explored within an area situated to the l. of grave 197; the pits contained some pottery sherds and animal bones (fowl legbones) overlaid by a thick layer of snails occurring in a depth of about 100 cm measured from the top of the filling.

Grave 198

(Pl. 24). D: 125; L: 140; W: 60. NW-SE. L. of skeleton: 120. F. Oval br. *earring* (1) with truncopyramidal glass bead-pendant in green. Two melonseed-shaped glass *beads* (2), light in colour.

Grave 199

(Pl. 24). D: 70; L: 180; W: 60. NW-SE. L. of skeleton: 145. F. Adultus. Anthr. *Earring* of poor-quality silver (1) with hoop missing; decoration: with a cluster made up of globules. Small br. *ring* (2). *Chicken bones* near the l. forearm.

Grave 200

D: 100; L: 190; W: 60. NW-SE. L. of skeleton: 150. F (?). *Pig bones* (young animal) in the region of the r. shoulder.

Grave 201

(Pl. 26). Grave-pit with projecting ledges, one at each of the long sides. D: 220; L: 220; W: 130-50. NW-SE. L. of skeleton: 160. M (?). Iron *knife* by the l. hand. *Pottery vessel* by the r. foot; coarse hand-made pot, blackish in colour; h: 11; rd: 10; bd: 7,5. *Pig bones* by the r. leg.

Grave 202

D: 145; L: 180; W: 50. NW-SE. L. of skeleton: 175. M. Adultus. Anthr. Forearms were bent so as to rest on the pelvis. Pieces of *charcoal* and „*burnt bones*”.

Grave 203

(Pl. 26). NW-SE. Db: during brick-earth digging. Quadrangular iron *buckle* within the pelvic area.

Grave 204

(Pl. 25). D: 100; L: 210; W: 60. L. of skeleton: 150. F. Adultus. Anthr. Oblong iron *buckle* on the r. ilium (?). Iron *knife* „gripped by the l. hand”. *Chicken bones* and *pig bones* in the region of the r. shoulder. *Egg* behind (?) the skull.

Grave 205

(Pl. 27). Grave-pit with projecting ledges, one at each of the long sides. Pieces of *charcoal* under (?) the skeleton. D: 210; L: 200; W: 120-80. L. of skeleton: 150. F. Maturus. Anthr. Oval br. *earring* (1) with glass bead-pendant missing; „by the skull”. *Glass beads*(5) around the cervical vertebrae; some melonseed-shaped beads, a spotted one, globular in shape, and two tiny milletseed-like beads. Two punch-decorated br. *bracelets* (2), circular in section; one on each arm. Oblong iron *buckle* (3) within the pelvic area. Iron *knife* above the r. femur. Disintegrated clay *spindle-whorl* (4). *Pig bone* (a rib) above the r. femur. *Chicken bones* near the feet.

Grave 206

(Pl. 27). D: 114; L: 200; W: 60. NW-SE. L. of skeleton: 150. F. Penannular br. *earring* (2) „by the skull”. Oblong iron *buckle* (3) within the pelvic area. Iron *clamp* (hook-nail, 2). *Chicken bones*.

Grave 207

D: 160; L: 200; W: 60. NW-SE. L. of skeleton: 145. F (?). Senilis. Anthr. Skeleton lying on its l. side with l. hand within the pelvic area, r. forearm doubled up under the chest. *Chicken bones* „in the l. hand”.

Grave 208

(Pl. 27). D: 100; L: 200; W: 60. NW-SE. L. of skeleton: 160. F. Iron *buckle* (1) within the pelvic area. Iron *knife* by the r. hand. *Egg* near the skull. Fragmentary *Union cockle* (2) „in the r. hand”.

Grave 209

(Pl. 27). D: 100; L: 220; W: 70. NW-SE. L. of skeleton: 165. M. Maturus. Anthr. Skeleton lying with hands clasped (?) above the pelvis. Oblong iron *buckle*. Iron *knife*. *Egg* on the chest. *Chicken bones* within the pelvic area.

Grave 210

(Pl. 26). D: 100; L: 200; W: 70. NW-SE. L. of skeleton: 153. F (?). The corpse had been wrapped in a shroud; a callus on the skull. Quadrangular iron *buckle* within the pelvic area. *Egg* under one of the scapulae.

Grave 211

(Pl. 27). D: 100; L: 200; W: 70. NW-SE. L. of skeleton: 142. F (?). „Lyriform” iron *buckle* within the pelvic area. *Chicken bones* on the chest.

Grave 212

(Pl. 27). Grave-pit with projecting ledges, one at each of the long sides. Double burial: F. and Ch. L. of skeleton: 155. Babe's skeleton lying prone on the l. arm bones of the femal's. Two oval br. *earrings* (2) with small globular glass bead-pendants missing; „by the skull”. Melonseed-shaped glass *beads* (5), dark and light green in colour, around the cervical vertebrae. Biconical clay *spindle-whorl* (4) decorated with girth-grooves. Two br. *bracelets* (6), rectangular in section, with slightly thickened terminals; one on each arm. Br. *finger-ring* (2) with circular bezel set with glass convex in blue; on the annular finger of the r. hand. Oblong iron *buckle* (3) within the pelvic area. Small iron *knife* „by the leg”. Cylindrical bone *needle-case* (7; +) with turned decoration of multi-ribbed type. *Chicken bones* near the feet.

Grave 213

(Pl. 27). D: 180; L: 230; W: 80. Double burial: F. Maturus. Anthr. and Ch. L. of skeleton: 150. Babe's skeleton „on the arms” of the femal, with feet in a position so as to rest in the femal's hand. Circular silver *earring* (1) with medium-sized hollow globe-pendant; „by the skull”. Rock-crystal *bead* (2) in the region of the cervical vertebrae. Oblong iron *buckle* (3). Iron *knife*. Biconical clay *spindle-whorl* (4), a worn one, grey in colour. *Pig bones* in the region of the l. shoulder; *chicken bones* on the bones of the feet.

Grave 214

(Pl. 28; Pl. VIII. 1-9). D: 160; L: 240; W: 70. NW-SE. L. of skeleton: 166. M. Maturus. Anthr. *Mount-decorated belt*. Cast br. *large strap-end* (9) with flat-leaf tendril decoration inside a pearled border; type of the strap-fastener: socket fitted with two projecting bird heads facing each other. Remnants of textile on the strap-end. Four cast br. *small strap-ends* (6) bearing flat-leaf tendril decoration; socketed specimens. Five cast br. *belt-mounts* with hinged pendants (4); shield-shaped upper parts decorated with plant pattern of foliate type in openwork; openwork shield-shaped pendants.

Griffin-decorated openwork cast br. *belt-mount* (7), oblong in shape. Ten cast br. shield-shaped *mounts for the pendent straps* (1), each decorated with a schematic human figure. *Belt-plate* (5) made of br. plate. Cast br. *propeller-shaped mount* (8) with beaded border. *Chicken bones* in large quantity, under the bones of the trunk and „under the r. elbow”.

Grave 215

(Pl. 28). D: 130; L: 220; W: 70. NW-SE. L. of skeleton: 175. M. Adultus. Anthr. Oblong iron *buckle* (1). Iron knife. Iron *clench-nails* for the coffin (2). *Chicken bones*.

Grave 216

Grave-pit with projecting ledges, one at each of the long sides. D: 145; L: 273; W: 75. NW-SE. L. of skeleton: 160. F (?). Db: skeleton lying on its r. side, bones of the l. arm were found „outstretched”; skull in a disturbed position. *Egg* in the region of the l. shoulder.

Grave 217

(Pl. 28). D: 100; L: 200; W: 70. NW-SE. L. of skeleton: 150. F. The deceased had been wrapped „in rush mat in shape of a boat”. Two oval *earrings* with bead-pendants missing; „by the skull”. Two *eggs*.

Grave 218

(Pl. 28; Pl. XV. 5-6). D: 175; L: 160; W: 70. NW-SE. L. of skeleton: 100. Ch. Forearms were bent so as to rest on the pelvis. *Bone object* (Fig. 3.) in shape of a truncated cone, with perforation near the edges; an incised all-over decoration on its surface; under the sacrum (?). Br. *rattle* (4) beside the narrower end of the former object. Iron *knife* between the legs. Cast br. *strap-end*(1) decorated with flat-leaf tendril, under the „end of the knife”. Oval br. *buckle* (3) with tongue missing. Small iron *clench-nails* (2) behind (?) the skull.

Grave 219

(Pl. 28). D: 160. NW-SE. Ch. D-shaped iron *buckle* (1) within the pelvic area. Two iron *rings* (2) linked together; in the same position. Small iron *knife*.

Grave 220

D: 120; L: 200; W: 70. NW-SE. L. of skeleton: 155. F (?). No grave-goods.

Grave 221

D: 100; L: 150; W: 50. NW-SE. L. of skeleton: 80. Ch. *Chicken bones* near the feet.

Grave 222

D: 90; L: 150; W: 90. NW-SE. L. of skeleton: 110. Ch. No grave-goods.

Grave 223

NW-SE. Db. Ch. No grave-goods.

Grave 224

(Pl. 29). D: 165; L: 170; W: 70. NW-SE. L. of skeleton: 115. Ch. Skeletal bones in decayed condition. Iron *knife* by the r. hand. Iron *rattle* (2); a pebble enclosed in the latter; „gripped by the l. hand”.

Grave 225

(Pl. 29). D: 150; L: 180; W: 70. NW-SE. L. of skeleton: 115. Ch. Glass *beads* (1) under the ribs, to the l. of the vertebral column; melonseed-shaped beads and a globular ones. Praehistorical br. spiral and iron *chain-links* joined together by rust (2).

Grave 226

(Pl. 29). D: 160; L: 220; W: 80. NW-SE. L. of skeleton: 155. F. Two circular br. *earrings*(1) with glass bead-pendants missing, „by the skull”. Biconical clay *spindle-whorl* (2), grey in colour, bearing traces of red painting. Oblong iron *buckle* (3; +). *Chicken bones* and *pig bones* between the knees.

Grave 227

(Pl. 29). D: 190; L: 220; W: 90. NW-SE. L. of skeleton: 160. F. Maturus. Anthr. Skeleton lying with arms bent at elbow and both forearms „ourstretched”. Iron *clench-nails* for the coffin (6), one in each corner of the grave-pit. Circular bronze-gilt *earring* of larger size (1) with globular glass bead-pendant; „by the skull”. Pair of circular br. *braist-clasps* (2) of eight-petalled rosette type with cells fashioned from twisted wire; under (?) the chin. Melonseed-shaped and milletseed-like glass *beads* (4) around the cervical vertebrae and on the chest. Two br. *finger-rings* (3), each with a circular

bezel set with a glass convex in green; one „on the phalanges of the r. hand”, the other „on the phalanges of the l. hand”. Iron *knife* on the r. part of the chest. Cylindrical silver *amulet case* (5) decorated with three ribbed silver bands on the chest. *Egg* by the r. hand.

Grave 228

(Pl. 29). D: 180; L: 220; W: 80. NW-SE. L. of skeleton: 154. F. Maturus. Anthr. Melonseed-shaped glass *beads* (1) around the cervical vertebrae. Clay *spindle-whorl* (2) in shape an oblate spheroid, decorated with girth-grooves; on the r. part of the chest. Oblong iron *buckle* (3) within the pelvic area. *Animal bones* (*chicken* and *pig*) in large quantity under the skeleton and above it.

Grave 229

D: 100; L: 220; W: 60. NW-SE. L. of the skeleton: 135. No grave-goods.

Grave 230

Grave-pit with projecting ledges, one at each of the long sides. D: 180; L: 230; W: 110-65. NW-SE. L. of skeleton: 152. M. „Semicircular widening” at the head-end of the grave-pit; *fish heads* and *chicken bones* round the skull.

Grave 231

(Pl. 29). D: 190; L: 230; W: 110. NW-SE. L. of skeleton: 155. M (?). Adultus. Anthr. Biconical clay *spindle-whorl* (2), grey in colour. Tin penannular *br. rings* (1) „by the skull”. *Pottery vessel* (3) found lying on the distal end of the l. tibia and fibula; hand-made pot, cylindrical in shape, grey in colour; h: 9,5; rd: 9; bd: 7,2. *Chicken bones*.

Grave 232

D: 120. NW-SE. M. Db: by digging out a tree. No grave-goods.

Grave 233

D: 120; L: 188; W: 60. L. of skeleton: 114. F. No grave-goods.

Grave 234

D: 160; L: 230; W: 80. NW-SE. L. of skeleton: 155. F. Adultus. Anthr. Skeleton lying with „hands clasped above the pelvis”. *Pig bone* behind (?) the skull; *chicken bones* near the feet. *Eggs*, one „in each hand”.

Grave 235

D: 110; L: 180; W: 50. NW-SE. L. of skeleton: 145. F (?). No grave-goods.

Grave 236

(Pl. 29). D: 190; L: 190; W: 60. NW-SE. L. of skeleton: 140. F. Senilis. Anthr. Biconical clay *spindle-whorl* (1), red in colour, decorated with incised triangles; below the chin. Cylindrical bone *needle-case* (3) with turned „ball-and ribs” decoration; on the r. ilium (?); iron *needle* endlosed in the needle-case. *Beads* (2) on the r. side of the skull; some globular glass beads, beads made of chalk, calcedon beads and some stone beads of stone axe-head type.

Grave 237

(Pl. 29). Grave-pit with projecting ledges, one at each of the long sides. D: 190; L: 205; W: 105. NW-SE. L. of skeleton: 155. F. Adultus. Anthr. Two oval br. *earrings* (1) with globular glass bead-pendants; „by the skull”. Iron *knife* in the region of the r. shoulder. Biconical clay *spindle-whorl* (2) grey in colour, decorated with a girth-groove; in the region of the r. elbow.

Grave 238

(Pl. 29). D: 110; L: 210; W: 50. NW-SE. L. of skeleton: 175. Db: pelvic area (?). Fragmentary iron *knife*. Iron *clamp*.

Grave 239

D: 110. NW-SE. Skeletal bones in decayed condition. Ch. No grave-goods.

Grave 240

D: 75; L: 180; W: 60. NW-SE. L. of skeleton: 147. F. Adultus. Anthr. Skull found tilting to its l. side. No grave-goods.

Grave 241

D: 75; L: 200; W: 80. Double burial: two skeletons lying side by side. F. Adultus. Anthr. and F. Senilis. Anthr. *Piece of iron* inside the mouth-cavity „of the smaller skeleton”.

Grave 242

D: 160; L: 190; W: 50. NW-SE. The bones of the skeleton crumbled to dust. No grave-goods.

Grave 243

D: 100; L: 170; W: 60. NW-SE. L. of skeleton: 128. The skull was found in crushed condition. No grave-goods.

Grave 244

D: 80; L: 140; W: 40. NW-SE. L. of skeleton: 115. Ch. No grave-goods.

Grave 245

(Pl. 30). D: 160; L: 180; W: 70. NW-SE. L. of skeleton: 125. Ch. Iron *knife* by the r. hand. Oblong iron *buckle* within the pelvic area.

Grave 246

(Pl. 29). Grave-pit with projecting ledges, one at each of the long sides. D: 190; L: 234; W: 105. „Traces of a wooden beam” in a depth of 90 cm. NW-SE. L. of skeleton: 158. F. Maturus. Anthr. „Decayed organic matter” under the skull and „rug-like remnants” under the skeletal bones. Two large circular br. *earrings* (1) with pendants missing; „by the skull”. Two br. *bracelets* (2), rectangular in section, with slightly thickened terminals; one on each arm. Iron *knife* to the r. of the pelvis (?). Oblong iron *buckle* (3) in the same position. Biconical clay *spindle-whorl* (4), grey in colour, decorated with incised zigzag lines; within the pelvic area. *Chicken bones* by the l. leg; *pig bones* by the r. leg. *Egg* of larger size „gripped by the l. hand”.

Grave 247

(Pl. 30). D: 155; L: 235; W: 80. NW-SE. L. of skeleton: 155. F. Skeleton lying with arm bent at elbow, both forearms „outstretched”, l. leg flexed and slightly drawn up; skull found in fragmentary condition. Two large circular br. *earrings* (1) with globular glass bead-pendants; in place of the skull. Yellow milletseed — like glass *beads* (4) in the region of the l. elbow. Melonseed-shaped glass *beads* (3) around the cervical vertebrae. *Silver fragments* of repoussé (2) „on the l. shoulder”. Oval iron *buckle* (5) within the pelvic area. *Eggs* in larger quantity, on the bones of the legs; egg „inside the l. elbow”.

Grave 248

(Pl. 30). D: 240; L: 240; W: 80. NW-SE. L. of skeleton: 164. M. Adultus. Anthr. Oval br. *earring* (1) with glass bead-pendant missing; „by the skull”. Quadrangular iron *buckle* (4) within the pelvic area. Small iron *clench-nails* for the coffin (3) within the pelvic area. Bronze-mounted small box small *vessel of br. plate* (2) by the l. hand; only some rim- and base-fragments of br. plate have survived. Broad-bladed iron *knife* by the r. leg. *Iron strike-a-light* (5) under the bones of the r. hand. Iron *axe* (6) found with cutting edge downwards, by the r. forearm; iron rings, three or four in number, on the wooden shaft about 80 cm in length. *Pottery vessel* (7) in the region of the feet; crude hand-made *jar* with cylindrical neck and body bulging so about in the middle; finger-impressed rim; h: 14; rd: 7,5; bd: 8,5. *Chicken bones* between the knees.

Grave 249

(Pl. 30). D: 100; L: 200; W: 70. NW-SE. L. of skeleton: 146. F. Circular br. *earring* (1) with glass bead-pendant missing, originally with cylindrical attachment bit; „by the skull”. Iron *knife* on the l. humerus. Iron *rings* (3). Biconical clay *spindle-whorl* (2), grey in colour.

Grave 250

NW-SE. Db. No grave-goods.

Grave 251

(Pl. 30). D: 125; L: 200; W: 80. NW-SE. L. of skeleton: 145. Oval silver *earring* (1) with cylindrical pendant, decorated with beaded wires, tipped with a hollow globular silver bead; „by the skull”. Iron *knife* by the upper part of the l. humerus near its inner side. Iron *buckle* with incurved sides (2) under the l. femur. *Chicken bones* between the legs.

Grave 252

(Pl. 30). D: 150; L: 250; W: 80. NW-SE. L. of skeleton: 170. M. Maturus. Anthr. Long iron *knife* in the region of the l. shoulder. *Iron ring* (2) at the upper edge of the l. ilium. Iron *buckle* with incurved sides (1), within the pelvic area.

Grave 253

(Pl. 30). D: 175; L: 250; W: 70. NW-SE. L. of skeleton: 148. F. Senilis. Anthr. Pennanular br. *earring* (1) „by the skull”. Trapezoidal iron *buckle* (2) within the pelvic area.

Grave 254

(Pl. 31). D: 160; L: 170. NW-SE. L. of skeleton: 70. Ch. Skull found tilting to its r. side. Circular silver *earring* (1) with small hollow globe-pendant (?); „by the skull”. Some glass *beads* (6) and iron *chain-links* (2) around the cervical vertebrae. Iron *knife* on the r. of the skeleton. Oval iron *buckle* (4) by the r. hand. Oblong iron *buckle* (5) within the pelvic area. *Pottery vessel* (3) recovered in crushed condition, near the feet; coarse hand-made pot, grey in colour; h: 11,5; rd: 7,5; bd: 5. *Chicken bones* in the region of the r. shoulder.

Grave 255

(Pl. 31). D: 190; L: 220; W: 70. NW-SE. L. of skeleton: 152. F. Adultus. Anthr. Two oval silver *earrings* (1) with large hollow globe-pendants; one on either side of the skull. Disc-shaped *spindle-whorl* (4) cut out of a grey pottery sherd; by the lower epiphyses of the radius and ulna. Iron *ring* (2) between the knees. Oblong iron *buckle* (3) within the pelvic area. *Chicken bones* by the l. hand.

Grave 256

(Pl. 30). D: 180; L: 170; W: 50. NW-SE. L. of skeleton: 123. F. Oblong iron *buckle* (1) within the pelvic area. Oval iron *buckle* (2) under the bones of the r. forearm. Five *eggs* within the pelvic area. *Chicken bones* in large quantity; on the knees.

Grave 257

(Pl. 31). D: 140; L: 200; W: 80. N-S. L. of skeleton: 155. *Awl* made of antler (1) under the pelvis. Oblong (?) iron *buckle* (2). *Animal teeth* „in the hand”. Iron *knife* under the bones of the r. hand.

Grave 258

(Pl. 31). Grave-pit with ledges, two at each of the long sides. D: 220; L: 230; W: 70. NW-SE. L. of skeleton: 154. Iron *clench-nail* for the coffin (2) on the bones of the l. forearm, near the elbow. Iron *strike-a-light* (1) by the l. caput femoris. Iron *knife* by the r. forearm. *Chicken bones* and *calf bones* in the region of the feet. *Egg* to the l. of the pelvis (?).

Grave 259

(Pl. 31). D: 170; L: 250; W: 95. NW-SE. L. of skeleton: 162. F (?). Two br. *rings* (1), one of them with open terminals; „by the skull”. Pennanular silver *finger-ring* (2) on one of the phalanges of the r. hand. Melonseed-shaped and tiny milletseed-like glass *beads* (3) occurring on the l. part of the chest and projecting beyond the ribs down to the pelvis. Two iron *buckles* (4, 5), one quadrangular the other oblong in shape; within the pelvic area. Trapezoidal iron *buckle* (6). Long iron *knife* by the l. femur. Iron *ring* (7) within the pelvic area. Fragmentary iron *clench-nail* for the coffin (8). *Pig bone* near the feet. *Egg* „griped by the l. hand”.

Grave 260

Fifth-century grave.

Grave 261

NW-SE. Db. M. Pig bones (ribs) on the bones of the feet.

Grave 262

(Pl. 31; Pl. XVI. 1-2). NW-SE. Db. The grave came to light „in the middle of the railway-embankment”; pottery sherds in large quantity, a burnt layer at the bottom, burnt skeleton beside the former. F. Adultus. Anthr. Two incomplete bronze-gilt *earrings* found „scattered” in the grave-filling; openwork pyramidal pendants each with a large metal globe on its apex.

Grave 263

(Pl. 30; Pl. XIX. 2). D: 170; L: 170; W: 70-100; grave pit widening downwards. NW-SE. L. of skeleton: 105. Iron *knife* by the l. foot. *Pottery vessel* to the r. of the skull; coarse hand-made pot, greyish-black in colour; h: 16; rd: 11,5; bd: 8,5. *Eggs* covering the bones of the thorax; egg „griped by the l. hand”.

Grave 264

(Pl. 31). D: 160; L: 190; W: 70. NW-SE. L. of skeleton: 145. F. Adultus. Anthr. Two large circular br. *earrings* (1) with large drop-shaped bead-pendants; „by the skull”. Tiny yellow and black milletseed-like glass *beads* (3) around the cervical vertebrae. Disc-shaped *spindle-whorl* (2) cut out of a grey pottery sherd. *Chicken bones* on the chest.

Grave 265

(Pl. 31). Grave-pit with projecting ledges, one at each of the long sides. D: 180; L: 180; W: 100-70. NW-SE. L. of skeleton: 135. F. Small circular br. *earring* (1) with a small globular glass bead-pendant; „by the skull”. Iron *knife* on

the l. part of the chest. Br. *mounts* (2, 4) from the handle of the knife. Disc-shaped *spindle-whorl* (5) cut out of a grey pottery sherd; in the central part of the chest. Br. *pendant* and glass *beads* (3) under the chin; tiny milletseed-like beads and a large flattened globe-shaped one decorated with two wavy lines cutting each other. *Chicken bones* near the r. forearm.

Grave 266

(Pl. 32). Grave-pit with projecting ledges, one at each of the long sides. D: 240; L: 240; W: 90-60. NW-SE. L. of skeleton: 165. M. Senilis. Anthr. Remnants of woven material under the skeleton; remnants of „leather clothing” on the femora. Penannular br. *earring* (5) on the l. side of the skull. Silver plate-fragments under the chin. *Disentangling hook* made of antler (4) with butt-end hollowed into trough-like socket of which decoration consists of a plain engraved double-line; in the region of the l. elbow. *Silver plate-fragments* of *small strap-ends* beside the disentangling hook. Fragmentary silver plate *large strap-end* (2) in line of the former fragments. Oblong iron *buckle* (1) within the pelvic area. Fragments of an iron *buckle* (+) under the former buckle. *Silver staining* on the bones of the forearms. Back-plate for a silver *strap-end* (7). Long iron *knife* enclosed in a wooden sheath; „in the l. hand”. *Whetstone* (3) „by the upper end of the r. femur”. *Chicken bones* near the feet.

Grave 267

(Pl. 32). D: 200; L: 200; W: 70. NW-SE. L. of skeleton: 145. F. Adultus. Anthr. Two circular br. *earrings* (1) with globular glass bead-pendants; „by the skull”. Green melonseed-shaped glass *beads* (2) around the cervical vertebrae. *Chicken bones* and *egg* near the feet.

Grave 268

D: 70-80. NW-SE. Ch. No grave-goods.

Grave 269

D: 70. NW-SE. Ch. No grave-goods.

Grave 270

(Pl. 32; Pl. XX. 1). D: 140; L: 130; W: 50. NW-SE. L. of skeleton: 90. Ch. Green melonseed-shaped glass *beads* (2) „along the shoulders”. Biconical clay *spindle-whorl* (4), red in colour; to the l. of the pelvis (?). Pair of circular *braist-clasps* of bronze-gilt (6), on the chest; decoration of the specimen preserved in fair condition: four-petalled rosette showing „petals” set with green glass and triangular cells, set with blue glass, between the individual „petals”; blue glass inlay in each field between „petal” and triangle. Fragmentary oval br. *earring* (1) with glass bead-pendant missing. *Pottery vessel* (5) near the feet; wheel-made reddish (brick-red) *bottle* with body bulging so about in the middle; decoration: horizontal grooves below the neck and on the belly; h: 14,5; rd: 5; bd: 6,5. *Chicken bones* and *egg* in the same position.

Grave 271

D: 150; L: 220; W: 70. NW-SE. L. of skeleton: 175. No grave-goods.

Grave 272

(Pl. 32). D: 150; L: 200; W: 60. NW-SE. L. of skeleton: 155. F. Disc-shaped *spindle-whorl* (3), red in colour, to the r. of the pelvis (?). Br. *fragment* (1) under the pelvis. Quadrangular iron *buckle* (4). Roman br. *coin* (2) pierced for use as ornament; under the pelvis. Iron *clench-nail* for the coffin (6) and fragments of similar objects; from the grave-filling. *Pottery vessel* (5) by the r. ilium; coarse hand-made pot blackish in colour; h: 14; rd: 11; bd: 9. Quadrangular iron *buckle* (4). *Chicken bones* and *eggs* in large quantity; on the chest.

Grave 273

NW-SE. Ch. No grave-goods.

Grave 274

(Pl. 33). D: 100; L: 190; W: 80. NW-SE. L. of skeleton: 135. F. Skull found tilting to its r. side. Iron *knife* near the feet. Yellow milletseed-like glass *bead* (2) within the pelvic area. Circular br. *earring* (1) with small globular glass bead-pendant; „by the skull”.

Grave 275

(Pl. 32). D: 170; L: 200; W: 65. NW-SE. L. of skeleton: 158. M. Maturus. Anthr. Circular silver *earring* (1) with medium-sized hollow globe-pendant; „by the skull”. Penannular br. *earring* (2). *Mount-decorated belt*. Silver plate *large strap-end* (5) by the l. hand. Two silver plate *small strap-ends* (4), one by the l. hand, the other by the r. ilium; the strap-ends had been plastered up with lead, only the silver bands, for fixing to the pendent straps, were found (about seven in number). Discoid *belt-mounts* of silver plate (3) under the bones of the r. hand and under the r. ilium; they were found in a poor state of preservation, about eleven specimens were rescued. Iron *buckle* with incurved sides (7), under the r. ilium. Quadrangular iron *buckle* (8). *Disentangling hook* made of antler (6) by the l. hand; butt-end hollowed into

a trough-like socket of which decoration consists hatching between margins. *Whetstone* (9) perforated with a hole, lying on the disentangling hook. *Chicken bones* by the l. leg or foot.

Grave 276

(Pl. 33; Pl. IV. 6-11). D: 220; L: 220; W: 70. NW-SE. L. of skeleton: 165. *Mount-decorated belt*. Silver plate *large strap-end* (4) under the l. ilium. Six *small strap-ends* of silver plate (2); three of them under the l. ilium and beside the large strap-end, two ones under the r. ilium, one specimen by the r. hand. Two small strap-end type *mounts* (3). *Disentangling hook* made of antler (7), by the r. hand; its butt-end hollowed into a trough-like socket of which decoration consists of a plain engraved line. Small *fragment of silver*; in the region of the former object. Quadrangular iron *buckle* (5) by the r. hand. Quadrangular iron *buckle* (6) under the sacrum (?). Iron *knife* by the r. hand. Fragmentary iron *strike-a-light* (8). Five silver *buttons* of hemispherical type; under the l. ilium. *Chicken bones* by the l. leg.

Grave 277

(Pl. 33). Grave-pit with projecting ledges, one at each of the long sides. D: 230; L: 230; W: 90-60. NW-SE. L. of skeleton: 145. F. Circular br. *earring* (1) with elliptical glass bead-pendant in green; „by the skull”. *Pottery vessel* (5) beside the skull; coarse hand-made pot, grey in colour; h: 15; rd: 13,5; bd: 10. Melonseed-shaped and globular glass *beads* (2). Oval iron *buckle* (4). Narrow-bladed iron *knife*. Disc-shaped clay *spindle-whorl* (3), red in colour, to the r. of the pelvis (?). *Chicken bones* within the pelvic area.

Grave 278

(Pl. 33). D: 150; L: 200; W: 600. NW-SE. M. Quadrangular iron *buckle* (1) within the pelvic area. Quadrangular iron *buckle* (2) under the r. ilium. Small *iron fragment*, under the pelvis. *Flint* (3) and bent br. *rivet* (4) in the same position.

Grave 279

NW-SE. Db. No grave-goods.

Grave 280

(Pl. 33). D: 135; L: 160; W: 160. NW-SE. L. of skeleton: 100. F. „With clenched r. hand”. Two oval silver *earrings* (1) with medium-sized hollow globe-pendants; on the r. side of the skull. Three globular glass *beads* with small bosses (2); in the region of the cervical vertebrae. Two oblong iron *buckles* (4, 5) within the pelvic area. Small iron *knife* from the same position. *Cylindrical bone needle-case* (7) with turned „balls-and-ribs” decoration. Iron *strike-a-light* (6). Flint by the r. leg. *Pottery vessel* (8) recovered in crushed condition; on the r. of the skeleton; coarse hand-made pot, grey in colour; h: 13; rd: 10; bd: 7,5. *Chicken bones* by the r. foot.

Grave 181

(Pl. 34). D: 170; L: 157; W: 80. NW-SE. L. of skeleton: 150. F. Adultus. Anthr. Two circular silver *earrings* (1) with medium-sized globe-pendants; „by the skull”. Four quadrangular *silver plates* (2) decorated with interlace pattern in repoussé; in the region of the l. shoulder. Cylindrical bone *needle-case* (3) with turned „ball-and-ribs” decoration; in the region of the l. shoulder; iron *needle* enclosed in the former. Iron *ring* (7) by one of the ends of the needle-case. Trapezoidal iron *buckle* (4) on the r. ilium. „*Burnt bone*” above the buckle. Disc-shaped *spindle-whorl* (5) cut out of a grey pottery sherd. *Pottery vessel* (6) on the l. of the skeleton; coarse hand-made pot, blackish-grey in colour, with finger-impressed rim-edge; h: 13,5; rd: 11; bd: 8,5.

Grave 282

D: 200; L: 200; W: 70. NW-SE. L. of skeleton: 155. Skeleton lying with legs slightly flexed. No grave-goods.

Grave 283

(Pl. 33). D: 120. NW-SE. Db. F. Circular silver *earring* (1) with large hollow globe-pendant; on the r. side of the skull. Four globular glass *beads* with small bosses; under the chin. Br. mount of *rosette*-type (3) „among the ribs” to the r. of the vertebral column. Disc-shaped *spindle-whorl* (5) cut out of a glazed Roman pottery vessel; under the r. scapula. *Scythian br. earring* (4) on the l. ilium (?). Iron *knife* by the l. hand. Br. *chain-links* (7; +). *Pottery vessel* (6) to the l. of the skull; coarse hand-made pot, yellowish-grey in colour; h: 10,5; rd: 12; bd: 8. *Chicken bones* under the bones of the l. foot (?).

Grave 284

(Pl. 34). Grave-pit with projecting ledges, one at each of the long sides. D: 170; L: 210; W: 150-100. NW-SE. L. of skeleton: 145. F. Maturus. Anthr. Disc-shaped *spindle-whorl* (3) cut out of a grey thick-walled pottery vessel; in the region of the l. shoulder. Two iron *bracelets* (4), one on each arm. Two circular silver *earrings* (1) with large hollow globe-pendants; „by the skull”. Seven many-coloured bossed glass *beads* (2) around the cervical vertebrae. Iron *knife* inside the l. humerus, near its upper part. *Awl* made of antler (6). Oblong iron *buckle* (5) within the pelvic area.

Grave 285

(Pl. 35; Pl. XIII. 1-14; Pl. XIV.; Pl. XVIII. 6). D: 180; L: 280; W: 95. NW-SE. L. of skeleton: 166. M. *Mount decorated belt*. Openwork double-plate *large strap-end* of cast br. (9); decoration bordered by beading: four human heads,

each depicted in medaillon form, three in profile, one full-face; each panel with two strap-fasteners in form of confronting animal heads („simurgh”). Four cast br. double-plate small *strap-ends* (8) with pearled borders; decoration: openwork plant pattern of florous scroll type; each panel with two projecting strap-fasteners. Twelve *belt-mount* with hinged pendants (2); shield-shaped upper parts bordered by beading, decorated with lily-like plant pattern in openwork; shield-shaped pendants showing stylized plant pattern. Two cast br. *belt-hole guards* (7), heart in shape, with leaf-like decoration surrounded by beading. Nineteen cast br. *mounts for the pendent straps* (4), triangular in shape; decoration: leaf-motif surrounded with a pearled border. Cast br. hinged *buckle* (1) consisting of an oval loop and shield-like belt-plate of which decoration consists of two confronting human heads framed by beading and trefoils on its base; richly decorated loop and *tongue*. *Belt-loop* (2) made of br. plate; surface of the front-plate shows engraved geometrized leaf-like pattern against a punched background surrounded by scalloped border (Fig. 4.1). Cast br. *propeller-shaped mount* (6) engraved decoration against a punched background (Fig. 4.2.) foliate scrolls with half-accantus type leaves. *Pottery vessel* (10) near the feet; wheel-made yellow *mug* with handle, body bulging in its lower part; traces of black painting on its surface; h: 13,4; rd: 7,5; bd: 5.

Grave 286

(Pl. 34). Lateral niche-type grave. D: 175; L: 230; W: 140. NW-SE. F. Db: in the region of the skull. Penannular br. *earring* (1) above (?) the skull. Iron *knife* on the bones of the l. forearm. Large-sized cylindrical bone *needle-case* (6) with turned „ball-and-ribs” decoration; on the bones of the l. forearm. *Iron plate* (5; an iron strike-a-light?) on the bones of the r. forearm. *Iron object* with an *iron ring* (7), on the bones of the r. hand. Oblong iron *buckle* (2) under the l. ilium. Two iron *buckles* (3, 4), an oblong-shaped one and a lyriform specimen, within the pelvic area. *Chicken bones* in the region of the skull. *Egg* on the chest.

Grave 287

(Pl. 34). D: 110; L: 230; W: 80. NW-SE. L. of skeleton: 155. F. Iron *knife* in the region of the l. shoulder. Disc-shaped *spindle-whorl* (3) cut out of a grey pottery sherd; by the l. hand. Two oblong iron *buckles* (1, 2) within the pelvic area.

Grave 288

(Pl. 34). D: 130; L: 260; W: 100. NW-SE. L. of skeleton: 155. F. Oblong iron *buckle* (1) by the r. hand. Two br. *bracelets* (2) with pointed terminals; one on each forearm. Small broad-bladed iron *knife* by the l. femur.

Grave 289

(Pl. 36; Pl. II. 8-9., 11). D: 190; L: 230; W: 70. NW-SE. L. of skeleton: 153. M. *Remnants of leather* under the skull. Double-plate silver *large strap-end* (2) with uneven sides, front-plate decorated in repoussé: „dot-and-comma” motifs surrounding a „violin-shaped” motif with a central roundel. Seven shield-shaped *belt-mounts* of silver plate (1; decoration of the front-plate consists of three concave dots and „dot-and-comma” motifs in repoussé (four backplates and three front-plates have survived); each mount lying in following position: under the pelvis, inside the r. elbow, on the vertebral column (near the sacrum), „under the l. elbow”, and on the upper edge of the l. ilium. Two oblong iron *buckles* (3, 5); one near the inner side of the r. femur, near the caput femoris, the other from an unknown position. Iron „hoe” (tool for woodworking?); 5) lying on the upper part of the r. femur. *Chicken bones* near the l. foot.

Grave 290

(Pl. 34). D: 100; L: 190; W: 80. NW-SE. L. of skeleton: 154. F. Oblong iron *buckle* (2) within the pelvic area. Circular (?) br. *earring* with large globular glass bead-pendant in black; on the r. side of the skull. *Egg* and *chicken bones* in the region of the r. shoulder and near the feet; dog skull cut or sawn up into two pieces; on the chest.

Grave 291

(Pl. 36). D: 165; L: 200; W: 70. NW-SE. L. of skeleton: 145. F. *Remnants of leather* under the skull. Oval br. *earring* (1) with large globular glass bead-pendant in white; „by the skull”. Six many-coloured bossed glass *beads* (2) around the cervical vertebrae. Small iron *chain-links* (5) among the beads. Iron *knife* by the l. forearm. Silver *finger-ring* (5) with „rosette-bezel” of repoussé; on one of the phalanges of the l. hand. Iron *tweezers* (6) in the region of the l. elbow. Oblong iron *buckle* (3) from the same position. Two *pottery vessels*, one on either side of the skull; 1. coarse hand-made pot with double-pitched lip, grey in colour; h: 13,5; rd: 10,5; bd: 8; 2. hand-made grey pot; h: 18; rd: 10; bd: 10. *Chicken bones* by the chin.

Grave 292

(Pl. 35). D: 180; L: 230; W: 90. NW-SE. L. of skeleton: 162. Iron *knife* by the r. hand. *Chicken bones* in the region of the r. arm.

Grave 293

(Pl. 36). D: 160. NW-SE. Db: incomplete skeleton (bones „from the waist downwards” missing). M. Iron *spearhead* (9) above (?) the r. shoulder; 1:36 cm. Two circular (?) silver *earrings* (1) with medium-sized hollow globe-pendants; „by the skull”. *Mount-decorated belt* „around the pelvis”; to judge by the surviving fragments the silver plate belt-ornaments must have been plastered up with lead; they are strap-ends, shield and „pseudo-buckle” in shape, some surviving ornamental details (concave dots, semicircles and beading) are indicative of geometrical design in repoussé. Oblong iron

buckle (8) on the l. ilium (?). Iron *knife* by the r. hand. Br. back-plate of a *large strap-end* (7) on the l. ilium (?). *Chicken bones* in the region of the r. shoulder.

Grave 294

(Pl. 35). D: 150; L: 200; W: 70. NW-SE. L. of skeleton: 140. F. Skeleton lying with „clenched hands”. Two circular silver *earrings* (1) each with a pendant made up of cone-frustum type setting and globular glass bead; „by the skull”. Disc-shaped *spindle-whorl*(2) cut out of a grey pottery sherd; by the l. hand. Iron *knife* in the same position. *Chicken bones*.

Grave 295

D: 70; L: 120; W: 40. NW-SE. L. of skeleton: 90. Ch. *Chicken bones* near the skeleton.

Grave 296

(Pl. 37). Grave-pit with projecting ledges, one at each of the long sides. D: 200; L: 220; W: 140-90-60. NW-SE. L. of skeleton: 132. F. Two circular br. *earrings* (1) with large globular glass bead-pendants in black; one on either side of the skull. Iron *knife* deposited near the inner side of the l. arm. Tiny segmented glass *beads* (2) from the same position. Disc-shaped clay *spindle-whorl* (5), yellow in colour; by the r. hand. Oblong iron *buckle* (3) on the r. ilium (?). Oblong iron *buckle* (4) under the pelvis. *Chicken bones* and *egg* by the l. leg.

Grave 297

(Pl. 35). D: 145; L: 190; W: 60. NW-SE. L. of skeleton: 147. Two oval silver *earrings* (1) each with a pendant made of a large hollow silver bead and cylindrical attachment bit; „by the skull”. Biconical clay *spindle-whorl* (3), grey in colour in the region of the l. elbow. Quadrangular iron *buckle* (4) within the pelvic area. Two *iron rings* linked together (2). *Chicken bones* in the region of the shoulder.

Grave 298

(Pl. 37). D: 135; L: 170; W: 50. NW-SE. L. of skeleton: 118. Two oblong *bone plates* (4), each decorated with two rows of dotted circles; one on the l. humerus, the other „attached to the pelvis”. Oblong iron *buckle* (1) in the region of the l. elbow. Iron *knife* „in the l. hand”. *Iron ring* (2) near the inner side of the r. femur. *Whetstone* and fragmentary *iron strike-a-light* (5) on the r. femur. *Pebble* (3) near the inner side of the r. femur. *Chicken bones* by the l. leg.

Grave 299

(Pl. 37). D: 135; L: 200; W: 70. NW-SE. L. of skeleton: 120. Ch. Bones of the trunk and those of the legs had been deformed (skeletal remains of an „crippled” individual). Oblong-shaped *purse fastener* of bone plate (1) decorated with dotted circles with incised geometrical and „amorphous” motifs (marks); „under the l. elbow”. *Disentangling hook* made of antler (3) „inside the r. hand”. Iron *knife* in the same position. Quadrangular iron *buckle* (2) under the pelvis. *Chicken bones* „in the l. hand”. *Egg* „in the r. hand”.

Grave 300

(Pl. 37; Pl. XIX. 3). D: 200; L: 220; W: 90-70. NW-SE. L. of skeleton: 180. M. Silver plate *large strap-end* (2) by the l. hand. Br. plate *buttons* of hemispherical type (1); they were found lying along the upper edges of the ilia and across the vertebral column. Two silver plate *small strap-ends* (6; +), one in the middle of the pelvis, the other at the outer edge of the r. ilium. Quadrangular iron *buckle* (3). Two bone plates for the *grip of a bow* (5); inside the r. forearm. *Pottery vessel* (4) to the r. of the skull; coarse hand-made pot in grey. *Fowl bones* by the r. knee. Iron *knife* between the r. hand and the r. leg.

Grave 301

D: 60; L: 150; W: 50. NW-SE. L. of skeleton: 125. *Chicken bones*.

Grave 302

D: 70; L: 180; W: 50. NW-SE. L. of skeleton: 128. No grave-goods.

Grave 303

(Pl. 37). Grave-pit with projecting ledges, one at each of the long sides. D: 200; L: 260; W: 140-80. NW-SE. L. of skeleton: 175. M. „Skull in an inverse direction” (?). „The skeleton had been poured over some kind of liquid; the skeletal bones were found in decayed condition”. Two oblong iron *buckles* (3, 4) within the pelvic area. Small *buttons* originally plastered up with lead; they had appeared in a stripe between the iron buckles and the „hip”; only tiny rivets survived. *Piece of iron* within the pelvic area. Two iron *strap-ends* (2; +), one near the r. hand, the other under the pelvis. Oval iron *buckle* (1). Iron *knife*, originally enclosed in a wooden sheath, deposited „on the lap” of the deceased.

Grave 304

(Pl. 38). D: 100; L: 140; W: 60. NW-SE. L. of skeleton: 100. Skeleton lying on its l. side. Iron *knife* near the inner side of the bones of the l. arm. *Iron ring* (1) above the pelvis (?). *Pottery vessel* (2) „on the upper part of the l. femur”; coarse hand-made pot, grey in colour; h: 8; rd: 6,5; bd: 5,5. *Chicken bones* „on the shoulder”.

Grave 305

(Pl. 38; Pl. IV. 14-23). Grave-pit with projecting ledges, one at each of the long sides. D: 170; L: 230; W: 90-60. NW-SE. L. of skeleton: 154. M. Two large circular *earrings* of bronze (1), each with a pendant made up of a cone-frustum type setting and glass bead (beads missing); „by the skull”. *Disentangling hook* made of antler (6), inside the r. forearm; its butt-end hollowed into through-like socket; decoration of the socket: hatching-like line-decoration between margins; chevrons-like pattern around the circular hole perforated in about the middle. Iron *knife* under the bones of the r. hand. Trapezoidal iron *buckle* (7) on one of the ilia. Iron *strike-a-light* (8) inside the r. forearm. *Mount-decorated belt*. Silver plate *large strap-end* (5) in the region of the l. elbow. Eight *small strap-ends* of silver plate (4), each with a narrow silver band at its upper edge; some of them inside the r. forearm, the others „in the region of the waist”. Six silver plate *belt-mounts* (5), strap-end in shape, each with a narrow fluted silver band at its upper edge. Six silver plate *buttons* (2) of hemispherical type.

Grave 306

(Pl. 38). D: 80; L: 240; W: 70. NW-SE. L. of skeleton: 160. Oblong iron *buckle* (1) within the pelvic area. Small iron *knife* „in the l. hand”. *Chicken bones* by the r. hand.

Grave 307

(Pl. 38; Pl. XX. 2). D: 100; L: 230; W: 80. NW-SE. L. of skeleton: 150. F. Two oval br. *earrings* (1) with large globular glass bead pendants in black; „by the skull”. Clay *spindle-whorl* (3) in shape an oblate spheroid, grey in colour, decorated with girth-grooves; on the bones of the l. hand. Iron *knife* from the same position. Oblong iron *buckle* (2) within the pelvic area. *Pottery vessel* (5) near the r. foot; hand-made thick-walled funnel-necked *bottle*, yellow in colour, with body bulging in its lower part; h: 23; rd: 8; bd: 9. Two *flints* (4). *Chicken bones*.

Grave 308

(Pl. 38). D: 70; L: 170; W: 60. NW-SE. L. of skeleton: 118. F (?). Oval silver *earring* (1) with small hollow globe-pendant: „on the temple-bone”. Glass *beads* (3) inside the r. elbow; many-coloured bossed beads and discoidal one in white. Fragmentary silver *rosette* of repoussé (6; +), in the same position. Disc-shaped *spindle-whorl* (4) cut out of a grey pottery sherd; within the pelvic area. Oblong iron *buckle* (5) near the spindle-whorl. Iron *knife*. Br. *strainer* (7; +); small spoon with perforations in the middle; beside the iron buckle. Small penannular *silver ring* (2; +). Badly shattered remains of a hand-made (?) *pottery vessel* (+) in the region of the r. shoulder. *Chicken bones*.

Grave 309

D: 20 (measured after removing brick-earth from the former surface); NNW-SSE. L. of skeleton: 165. M. Cast br. *strap-end* on the r. of the skeleton. Br. *buckle* between the knees. *Small strap-end* by the l. femur. Six discoid *belt-mounts* (?); „three of them beside the large strap-end, one in the middle, two ones on the l. side”. Four quadrangular br. *plates* „in the region of the belt”. *Belt-loop*.

Grave 310

The grave was found after removing brick-earth; incomplete skeleton near the grave 309; F. *Chicken bones* by the l. hand. Fragmentary br. *breast-clasps*. Iron *knife* by the r. hand.

Grave 311

(Pl. 39). D: 75; L: 175; W: 60. NW-SE. L. of skeleton: 118. Ch. Db: by cultivation of the land; mandible found separated and lying on the dome of the cranium; bones of the r. leg missing; skeletal bones in decayed condition. Br. *earring* (1) with a pyramidal pendant made up of three granules; „by the skull”. Iron *bracelet* (+) on the l. forearm. Two *iron rings* linked together (2; +) between the femora, near the knees. Biconical clay *spindle-whorl* (+), grey in colour, outside the l. elbow. Iron *fragment* between the l. hand and femur. *Calf bones* near the feet.

Grave 312

D: 65; L: 220; W: 60. L. of skeleton: 160. F. Skeleton lying with „legs close to each other”. Two br. *earrings* with glass bead-pendants (+), a circular and an oval specimen; one on either side of the skull. Disc-shaped clay *spindle-whorl* (+), grey in colour; by the r. foot (or under the pelvis). Iron *buckle* (+) within the pelvic area. Iron *buckle* (+) by the l. foot. *Chicken bones* in large quantity, to the r. of the r. knee; *pig bone* (scapula) in the same position.

Grave 313

D: 65; L: 220; W: 60. NW-SE. L. of skeleton: 158. Two iron *clench-nails* for the coffin (+); one above (?) the r. shoulder, the other in the region of the l. shoulder. Iron *buckle* (+) under the vertebral column. Iron *knife* (+) under the bones of the r. hand, near the pelvis. Iron *ring* (+) „on the outer side” of the r. ilium. Iron *strike-a-light* (+) and *flint* (+) under the bones of the l. hand. Oblong iron *buckle* (+) in the same position. Iron *fragments* (+) „by the femur”, somewhat higher than the knee. *Chicken bones* above (?) the knees; *chicken skull* (+) under the pelvis.

Grave 314

(Pl. 39). D: 40; L: 220; W: 70. NW-SE. L. of skeleton: 162. M. Db: by cultivation of the land; skull missing. Two oblong br. *hairplait-ornaments* (1; +); decoration in repoussé: simple interlace patterns separated by a row of embossed dots, and surrounded by series of embossed dots. *Iron strike-a-light* (+) and *flint* (+) joined together by rust; in the region of the l. hand. *Strap-end* of br. plate (2; +) under the r. ilium. *Mount* made of br. plate (3; +) showing interlace pattern; beside the strap-end. Small br. *plate* (+) in the region of the r. hand. Long iron *knife* (+) under the bones of the r. hand. *Chicken bones* in large quantity; under the knees and between the feet.

Grave 315

D: 50; L: 200; W: 60. NW-SE. L. of skeleton: 126. Db: skull missing. Iron *buckle* (+) within the pelvic area. Hand-made *pottery vessel* (+) by the l. femur; h: 12; rd: 9; bd: 7,5.

Grave 316

(Pl. 39). D: 105; L: 220; W: 70. NW-SE. L. of skeleton: 136. Fragmentary skull found displaced. Circular br. *earring* (+) in position of the skull. Iron *buckle* (+) in the central part of the chest. *Iron ring* (+) at the outer edge of the r. ilium. Fragmentary iron *buckle* (+) lying on the iron ring. Circular iron *buckle* (+) under the r. elbow. Iron *knife* (+) in the same position. A mass of rusted objects under the pelvis: *iron strike-a-light* (+), iron *buckle* (+) and two br. *plates* bearing triangle-shaped pattern in openwork.

Grave 317

D: 50; L: 210; W: 60. Db. Skull missing. Iron *buckle* (+) on the l. ilium (?).

Grave 318

D: 40. Db. No grave-goods.

Grave 319

D: 120; L: 210; W: 80. Db. L. of skeleton: 154. F. Arch. Two silver *earrings* (+) with large hollow globe-pendants; one on either side of the skull. Glass *beads* (+) under the chin and on the chest; melonseed-shaped beads in blue and black globular beads with white bosses. Globular black clay *spindle-whorl* (+) near the inner side of the r. humerus. Iron *knife* (+) by the l. hand. Rectangular iron *buckle* (+) on the r. ilium (?). *Flint* (+) under the skull. *Chicken bones* (+) under the knees and between the legs (?).

The grave-goods excavated from graves 311-319 have not survived, the only information about them is supplied by some drawings (Pl. 39). Graves 309 and 310, as mentioned in Chapter I, are burials associated with another cemetery (Fig. 1).

Stray-finds

- Pl. 39.
- 1-7 Hoops of br. earrings
 - 8-10 Mounts for the pendent straps of belts
 - 11 Br. belt-hole guard
 - 12 Belt-mount with hinged pendant missing
 - 13 Melonseed-shaped glass beads
 - 14-18 Clay spindle-whorls
 - 19-25 Flints
 - 26-29 Iron buckles
 - 30 Iron horse-bit
 - 31 Iron awl
 - 32 Disentangling hook made of antler
 - 33-34 Pieces of animal bones bearing traces of elaboration
 - 35 Bones needle-case

III. BURIAL CUSTOMS

1. The grave pit

As a result of the excavations at Kundomb a total number of 319 graves were unearthed, two of which: 309, 310 were assumed to have belonged to another Avar cemetery one of the graves (260) dates from the fifth century.⁶ Thus the total number of the excavated graves of the Kundomb Avar cemetery amounts to 316. 320 dead were buried in the 316 graves, as there were six double burials. On the other hand, there were two empty grave pits in the cemetery: 106,

107. Of the deceased 136 were female, 78 male and 64 children. The sex of 42 skeletons could not be determined. From the skeletal material 176 skulls were preserved and deposited in the Institute of Anthropology of the Szeged University.⁷

(a) The most frequent grave type in the Kundomb cemetery is *shaft grave* oblong shape with vertical walls. No significant difference was found between the shape of the graves when first noted and that of the grave floors. Among the graves two types of interest were observed: the first the *lateral niche-type grave*, the second a *pit with projecting ledges* at its long sides.

The *lateral niche-type* is represented by grave 286.⁸ The deceased was deposited into the hollow (niche) scooped out in the grave-wall along the long side of the 175 cm deep pit. Unfortunately the pit was disturbed and only a few iron objects, no closely datable finds could be rescued.

The second grave type was the *pit with projecting ledges*. 25 such graves were found in the Kundomb cemetery. They were oblong pits wider than usual with a ledge along one of the long sides or with a ledge along each of the long sides.⁹ Graves 20, 22, 24, 32, 34, 35, 56, 75, 153, 201, 205, 212, 216, 230, 237, 246, 265, 266, 277, 284, 296, 303 and 305 belong to the type with one projecting ledge along each of the long sides. The pit of grave 230 showed a „semicircular widening” at the skull-end where fish heads and poultry bones came to light. „Two-ledge graves” (pit with two projecting ledges at each of the long sides) were 49 and 258. As shown by the numbering, graves with projecting ledges occurred all over the excavated area of the cemetery. They are mostly female burials, yet also male burials were found among them. Most burials belong to the late burial phase within the cemetery (sets of belt ornaments cast in bronze were found in graves 20, 35 but burials of the early phase were also found: 265, 284, 296, 303, 305). The majority of them contained grave-goods, and unfurnished graves were also found.

(b) The *dimensions of the grave pits* were noted in almost every case, as the contours were clearly outlined in the soil. The average length of oblong pits with rounded corners were the following: children's graves 70–100 cm, female graves 150 cm, male graves 200–240 cm. No difference was observed in their widths that measured 60–80 cm. Exceptions were graves 126 (length 280 cm) and grave 130 (length 310 cm), grave 60, of 110 cm width, graves 130 and 22, of 130 cm width. It should be noted that the width of grave 241 containing the skeletons of two adults (a female and a male) was only 80 cm.

(c) The *depths of the graves* were carefully noted in the excavation reports. Yet, as already mentioned, the surface of the area of the excavations was disturbed to such an extent that the data concerning the depths of the pits should be considered to be of relative value only and in the lack of a map with contour lines their standardization was impossible. The variations of the surface were furthermore enhanced by floods rather frequent in the environs of Szeged. The excavators noted that the flood levels were often distinguishable in the profiles of the grave pits. The depth of the pits averaged 150–160 cm, but shallower pits were also found, such as grave 88 (45 cm), grave 319 (25 cm). The deepest pits were 200–240 cm deep. Still deeper than that was the richly-furnished grave 35, of a male, with a set of belt-ornaments cast in bronze.

2. The deposition of the dead

(a) The dead buried in the Kundomb cemetery were usually deposited in an *extended supine position*, with arms extended along the body.

Except for many cases when the skull was found tilting to its right or left side, positions other than supine were seldom observed. Skeletons lying on the *right* side were found in graves 29, 153, 216; lying on its *left* side in graves 115, 304. *Positions of arms differing from the usual* were observed in graves 13, 23, 33, 131, 163, 183, 202, 207, 209, 212, 216, 218, 227, 234; the *unusual position of the legs* in graves 29, 172, 282 and 312. Both arms and legs were found in positions other than usual in graves 161, 162, 247. Though grave 112 was undisturbed, the position of the skeleton according to the report was noted to be differing from usual.

(b) The skeleton in grave 60/a and probably that lying in grave 47 was found in *contracted position*.¹⁰

(c) No remains of wood indicating the presence of *coffin burials* were discovered in the Kundomb cemetery. However, smaller or larger iron clench-nails (hook-nails) were found in several graves which would indicate that the dead was buried in a coffin. Nevertheless the records do not mention traces of wooden coffins, nor the presence of any wooden construction (the only exception is grave 246 where traces of a wooden beam were observed in a depth of 90 cm). This

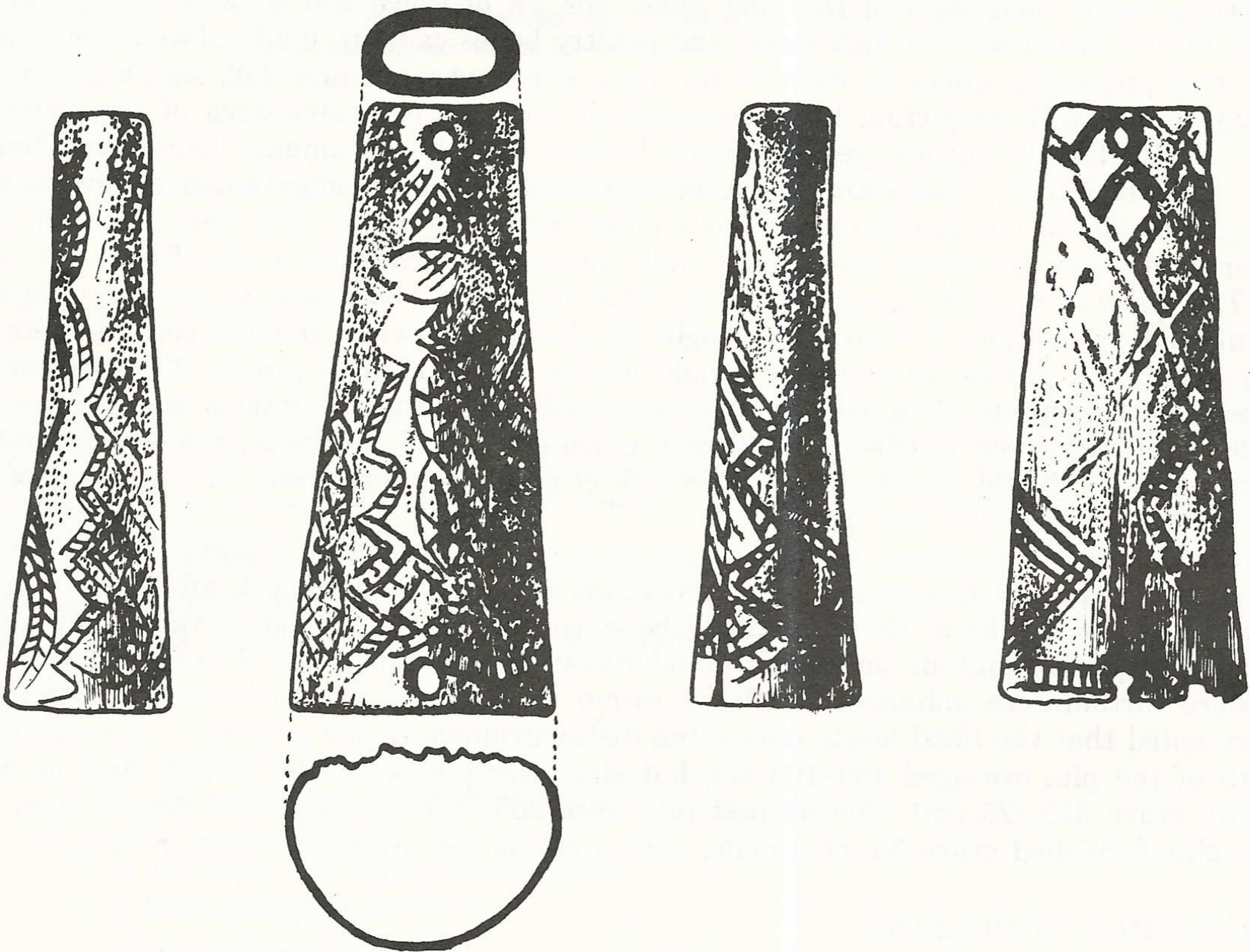

Fig. 3. 1a-1d The decoration of the bone object found in grave 218

is the stranger as the soil of Kundomb has preserved amyn traces of organic matters. Leather and textile remains could easily be identified to such a degree as, in addition to the sorts of the particular materials, their various forms, e.g. blankets, fabrics, silk could also be distinguished.

The *iron clench-nails* were made of very poor materials. They have been preserved only in fragments. Their find spots in the graves differed and were often found in layers considerably higher than the skeleton. Such was the case with graves 143, 147 and 227. In a discussion on graves with projecting ledges it was suggested that wooden boards put crosswise were used to coles the grave pits and the iron hook-nails served to fix the timber. Iron clench-nails were found in 21 graves namely 20, 27 (?), 64, 68, 80, 99, 102, 143, 145, 152, 169, 177, 181, 215, 218, 227, 248, 259, 272 and 313. Most of these graves belong to the late burial phase within the cemetery. Iron clench-nails were found in almost all graves that contained „yellow pottery”.

(d) Six *double burials* were unearthed in the Kundomb cemetery. In five of them, namely graves 84, 148, 183, 212, 213 mother and babe were buried in the same grave. In grave 84 the skeleton of the child lay beside the right femur of the female skeleton; in grave 148 the child was laid onto the right arm; in grave 183 the child's skeleton was found lying on the legbones of the female's; in grave 212 a child was deposited on the left arm of the female; in grave 213 the babe was placed onto the arms of the female. In another case a female and a male, both of advanced age, were buried in the same pit (grave 241).

(e) *Further observations*

In graves 246 and 266 a piece of textile had been laid on the grave-floor before the deposition of the dead; in graves 52 and 210 the deceased were wrapped in shrouds. In grave 217 the dead was wrapped in *rush mat* „in shape of a boat”.¹¹

In several cases the skeletons had completely *decayed* „as if poured over with some liquid”. The skeletons were as good as absorbed in graves 175, 181, 185, 186, 239 and 303. The sequence of the numbering of the graves perhaps indicates tha these graves were found near each other.

The deceased buried in grave 257 held *animal teeth* in its hand; in grave 101 an iron *sickle* was deposited near the left arm; in that 208 *Union cockle* were found „in the right hand” of the skeleton.¹² In grave 241 a small *piece of iron* was found inside the mouth-cavity „of the smaller skeleton”; the excavator believed that it might have been some sort of „obul”.¹³

3. *Animal burials*

Next to male grave 76, on the left side, „in a pit touching the leg and waist” of the deceased in the grave a complete skeleton of a cattle was found.

4. *Traces of funeral feasts and food offerings*

Traces of food and drink offering were found in 186 graves, that is to say, roughly in the half of the excavated ones. Drink offerings were places in 14, food in 136 and both in 36 graves.

(a) No animal bones were found in the *pottery vessels* unearthed in the Kundomb cemetery. Therefore it may safely be assumed that the vessels had contained no meat. Most vessels were deposited near the feet, and several of them at about the middle of the dead body. Pottery vessels were found in the region of the skull in graves 111, 127, 169, 263, 277, 283, 291, 300; in the region of the right shoulder in graves 57, 308; near the left humerus in grave 10 and 130; at the height of the pelvis in graves 73, 86, 272; in grave 304 the pottery vessel was found „on the upper part of the left femur”. As a rule, a single vessel was placed beside the dead body. Two vessels in a grave were found in three cases. Two hand-made vessels were excavated from graves 63 and 291; in grave 63 one item was found near the right leg, the other in the region of the right knee; in grave 291 a pottery vessel came to light on either side of the skull. Grave 143 yielded two wheel-made vessels; one of them, a jar was found near the feet, the other, a mug in the region of the right knee. The vessel in grave 54/a was found in the filling of the grave, without indication of the depth of the find spot.

A *wooden bucket* with iron hoops and a handle was recovered form grave 17. In this grave of a girl the bucket was deposited near the right hand of the deceased. The same grave yielded two strings of beads, one of them with a crescent-shaped pendant. Eggs were deposited in the bucket.

(b) The *animal bones* found in the excavated graves of the Kundomb cemetery were determined by the excavators. As regards the animal bones it is uncertain the finds were inventorized in the

Szeged Museum or sent to the Institute of Anthropology together with the anthropological finds. Poultry bones were found in 131 graves,¹⁴ pig bones in 36,¹⁵ calf bones in 2, a skull of a small carnivore in 1 grave, skulls of dogs in 3 graves. Fishbones or fish skulls were recovered from 4 graves.¹⁶ Poultry bones and pig bones were mostly found in female graves. Fish-bones and dog skulls were recovered from female grave. In 2 graves, namely 196 and 202 the animal bones showed traces of fire.

(c) *Eggs*. Large quantities of eggs were found in the graves of the Kundomb cemetery.¹⁷ They were recovered from 55 graves. Usually one egg was placed in the grave, but occasionally two or more eggs were deposited in four cases, namely graves 6, 46, 101, 135, four in grave 124, five in 256, six in 153. „Several” eggs were found in graves 17, 40, 104, „many” in graves 33, 247, 263. The skeleton was all covered with eggs in grave 33. The majority of the eggs were found in female graves. In grave 17 the eggs were also placed in the bucket.

5. *Mutilation of the dead. Skull robbery*

In the Kundomb cemetery there were phenomena indicative of the mutilation of the dead in order to prevent them from returning.

The right ulna and radius of the skeleton in grave 52 and the bones of the right lower limb of the skeleton in grave 311 were found missing. In grave 58 the skull lay near the feet, whereas in grave 20 the skull was found in the grave filling, a half meter higher than the skeletal bones. The skulls were missing from graves 314, 315, 317; all these graves lay at rather high levels, but the skeletons were intact, and so were the graves goods.

6. *Orientation*

The orientation of the graves in the Kundomb cemetery as uniformly NW–SE with skull pointing NW. In grave 303 the skeleton was found lying in the opposite orientation, with skull pointing to SE. According to the excavation diary slight divergences from this dominant orientation were found. Exceptions were the following: a N–S orientation was observed in graves 3, 10, 29, 41, 46, 59, 62, 63, 64, 180, 257. NE–SW orientation was observed in grave 58, and E–W orientation in grave 179. Graves 180 and 179 date to the early burial phase within the cemetery. According to the report the positions of the graves did not show any particular pattern. The distance between the graves varied, ranging from 300 to 100 cm.

7. *Disturbed graves*

Compared to other cemeteries the number of disturbed graves was small; male graves: 20, 53, 131, 138, 139, 145, 261, 293, 314; female graves: 65, 72, 90, 104, 112, 137 (?), 141, 150 (?), 158, 161, 216 (?), 262, 283, 286; adult of unknown sex: 28, 30, 37, 77, 78, 91, 95, 96, 100, 106, 107, 119, 203, 238, 250, 315, 316, 317, 318; children’s graves: 81, 86, 146, 197, 223, 245, 311.

8. *Other phenomena observed*

Traces of fire were observed in some graves of the Kundomb cemetery: 2, 7., 13, 14, 27, 42, 202. They were mostly found under the skeletal bones, in grave 43, a layer of ashes 2–3 cm thick was found 30 cm above the skeleton, and the grave-floor showed traces of burning too.

In the Kundomb cemetery there were phenomena indicating the presence of a cult plate where funeral rites could be performed prior to the depositing of the corpse.¹⁸ To the left of grave 190 six pits 170 cm wide and about 160 cm deep were discovered. In one of them, at a depth of 1 m a thick layer of snails, under the legbones of a colt and pottery sherds were unearthed. Snails were found in all the six pits. Under the skeleton in grave 262 the earth showed traces of fire, and the skeleton itself was also partly calcinated. In the filling of the pit pottery sherds were discovered. The filling above the skeleton yielded a pair of incomplete gilt bronze earrings with pyramidal pendants. Near the skull in grave 87, in an ashy pit of small size bronze fragments, a bone awl and an animal bone with smoothed surface were found.

Empty grave pits — kenotaphia —¹⁹ were graves 106 and 107 of the Kundomb cemetery.

IV. GRAVE-GOODS

The number of the graves excavated in the Kundomb cemetery was 316. Among those buried 136 were females, 78 males and 34 children. The sex of 42 skeletons could not be determined.²⁰ No grave-goods were found in 52 graves.

1. Dress and personal ornaments

(a) *Male graves.* Out of the 78 graves 12 were without grave-goods.

Mount-decorated belts were found in 37 graves, out of which one was the grave of a child (a young boy): in 13 cases belts decorated with repoussé mounts, in 5 graves the belts were decorated with mounts fashioned from bronze plates and in 17 graves belt-ornaments cast in bronze were found. In one of the graves a North-Italian type belt-set was unearthed.²¹

Three groups of belts *decorated with repoussé belt-ornaments* have been found in the Kundomb cemetery, namely:

belts with many pendent straps, shield-shaped and double-shield-shaped belt-mounts and broad, shield-shaped strap-ends (graves 102, 180, 289)

belts with many pendent straps; narrow-type strap-ends and small buttons: (graves 179, 266 (?), 275, 276, 300, 313, 315);

a Környe-type broad belt with many repoussé belt-mounts plastered up with lead was found in grave 293.

1) In male grave 180 containing weapons a complete set of belt-ornaments (silver repoussé) was found. No sketch of this grave was drawn up and we can only publish an earlier photo of the finds, when the mounts had still been in a better condition. The belt was decorated by six shield-shaped mounts, a double-shield-shaped mount and eight small strap-ends; a large strap-end and a buckle belonged to the belt-set. The decoration of the front plate of the large strap-end is of the same form and pattern of that of the large strap-end found in grave 289. This belt type belongs among the earliest specimens.²² A matrice for pressed foils similar to that of the large strap-end was brought to light in the Adony cemetery²³ and a similar matrice for double-shield-shaped mounts was unearthed in the Szekszárd-Palánk Avar cemetery²⁴ Matrices for pressed foil of similar pattern make part of the Fönlak (Felnac) finds.²⁵ According to the excavation records the belt was fastened by an iron buckle; the bronze buckle cast in one piece with its belt-plate could have belonged to the attachments of the sword.

A similar belt was found in grave 289, yet here the double-shield-shaped belt-mount is absent. Out of the strap-ends and shield-shaped belt-mounts very little has been preserved. The decoration consists of a group of three concave dots surrounded by „dot-and-comma” motifs well known from the Fönlak (Felnac) finds. An iron buckle belonged to the belt also here. The length of the mounts is 25 mm, that of the strap-ends 30 mm.

A third belt of similar type was found in grave 102. Here the gilt-silver large strap-end is decorated with interlace pattern surrounded by beading. Its closest parallel is provided by one of the matrices of the Fönlak finds.²⁶ Among the shield-shaped belt-mounts and strap-ends only a single specimen has survived, in a rather poor state of preservation. A fact that may safely be stated is that the decorations differ from those found in graves discussed above. They were probably decorated with an almond-shaped central motif like the mounts of similar type found in the Avar Period cemetery at Mezókovácsháza.²⁷ The two iron strap-ends found in graves 180 and 202 probably belonged to other belts.²⁸ In both graves Roman bronze coins were found. Grave 180 was aligned N-S, head at north end.

2) A belt carrying many pendent straps with small strap-ends of narrow type²⁹ was found in grave 179. In addition to the large strap-end three small strap-ends and circular mounts belong to the belt-set; the only decoration of the slightly convex mounts is the plain raised border. A cast oval bronze buckle belonged to the belt. Two silver plate strap-end-shaped mounts were found near the tang of the knife belonging to the grave-goods.³⁰

A similar silver-mounted belt had been deposited in grave 276. In addition to the large strap-end six small strap-ends and two small strap-end type mounts were found under the ilia. Above the small strap-ends the belt was decorated by hemispherical buttons.³¹ The belt was fastened with an iron buckle.

On another belt excavated in grave 300 there were hemispherical buttons above the small strap-ends; we have no reliable information on the number of the small strap-ends.

The belt in grave 305 is identical with that of grave 276, however the number of small strap-ends was 11, and the number of small strap-ends-shaped mounts was 6. The belt was decorated partly by the latters, partly by hemispherical buttons. To the same type of belt-sets belong those excavated in graves 266, 275 and 303. In grave a large strap-end of silver plate and four fragmentary silver plate small strap-ends were found: grave 275 yielded a silver plate large strap-end and discoid belt-mounts appearing in a row under the bones of the right hand and the right ilium; according to the excavation records three small strap-ends belonged to the belt-set. In grave 303 there were „lead buttons” (presumably buttons plastered up with lead) and two small-sized iron strap-ends were found.

Besides graves 180 and 102 mentioned above there was an iron strap-end also in grave 76. In grave 179 the skeleton was lying with skull pointing E.

3) The repoussé mounts of the belt in grave 293 are quite fragmentary. When brought to light they were in such a damaged condition that their shapes were not even put down in the excavation record. The decorations of the surviving belt-mounts are in connection with those of the mounts belonging to group 1), concave dots and semicircles, yet, based on the fragments of the mounts we may state that the belt was decorated with mounts of shapes of great variety. There were strap-end shaped and pseudo-buckle mounts, too. From the large strap-end only the back plate has survived. The repoussé belt-mounts plastered up with lead were fastened to the belt by U-shaped bronze strips, of 14 and 23 mm size, respectively. 14 of them have been preserved. The belt of grave 293 appears to be a Környe-type belt.³²

The belts decorated with mounts fashioned from metal plates are likewise classed in three groups, namely:

Kundomb-type belt with mount-groups consisting of five mounts in the middle of the back part of the belt: graves 52, 71, 83;

Belt decorated by quadrangular mounts: graves 23, 58, 314;

Belt-mounts cut out of bronze plate were found in grave 61.

1) In graves 52, 71 and 83.

„Kundomb type” belts were found.³³ The silver-plate mounts were applied to some harder metal, such as bronze or iron. The greater part of the mounts are oblong in shape; the belt in grave 83 was decorated with rosette mounts. The group composed of five mounts is applied to the back, its central member being an oblong-shaped mount, which, in grave 71, was decorated by a central cell set with glass inlay. On the right and left a pair of triangular mounts joins it. Above and below the oblong-shaped mount there are strap-ends of the same width.

On the Makkoserdő belt of similar type the strap-ends are reinforced by narrow bronze straps, strengthening straps two for each of them to fasten them on the inner side of the rectangular mount on the inner part of the belt.³⁴ This structure supports the assumption that these belts had been extended only above and below the central mount, and the strap-ends were pulled over these extended parts. The function of the extended back centre is unknown. There is no information in hand whether, besides the embellishment of the belt had had further functions, too, e.g. to express a social or a military rank. A large strap-end, belt-hole guards, and to some of them also small strap-ends belonged to the belts. In grave 52 the belt had a „Balgota type” Byzantine buckle, that of grave 83 a bronze buckle cast in one piece with its belt-plate. In graves 52 and 83 large-sized (long) knives were unearthed in each, probably suspended from a second belt fastened by an iron buckle. In these two graves neither pottery vessels for animal bones were found.

2) Among the belts decorated with rectangular mounts we will first discuss the belt-mounts found in grave 23, because they are different from repoussé mounts and from those cut out of metal sheet alike. Openwork repoussé mounts are seldom found in the Avar Period material excavated in Hungary. The only complete set is that of Kundomb. Observations made during the excavations indicate that the belt was placed unfastened upon the dead body. The cast belt-plate of the buckle is of the openwork type like the belt-mounts. The belt-set thus manufactured was considered to be complete. Five quadrangular mounts were grouped 3 : 2 yet, according to the records taken there had been two additional rectangular mounts that were destroyed in the course of the excavations. The find-spot of these two belt-mounts is unknown; they had probably adorned the left side of the belt. According to the excavation records some triangular mounts, three

belt-hole guards and a belt-loop decorated with a female half-length portrait depicted „en face”, a large strap-end (gilded) showing interlace pattern of repoussé, two small strap-ends with trellis pattern and two others bearing plant-pattern belonged to the belt. The strap-ends mentioned last might have belonged to another belt on which a large-sized knife was suspended. Another possible alternative is that the two identical strap-ends with plant pattern decorated the sheath of the knife.³⁵

In grave 58 a large strap-end, a quadrangular belt-mount and a belt-hole guard have been preserved. A buckle cast in one piece with its quinquangular belt-plate belonged to the belt.

From the grave-goods of grave 314 only the large strap-end and fragments of a belt-mount decorated with interlace pattern are known. The strap-end consists of two plates attached together by a narrow side band.

3) The belt of grave 61 was decorated with „spur-shaped” silver plate belt-hole guards. Similar mounts were found also in other graves (e. g. grave 58).

Belts decorated with cast bronze belt-ornaments were found in graves 18, 20, 35, 38, 53, 111, 124, 130, 139, 140, 143, 145, 152, 168, 214, 285.

Based on the shapes and decoration of the belt-ornaments found in 16 male graves, the mounts have been assigned into four groups.³⁶

In group 1) belong the belts whose ornaments decorated by flat-leaf tendrils: those in graves 18, 35, 53, 130, 140, 152, 214.

Those bearing plant patterns of various types in an axial arrangement belong to group 2): graves 38, 124, 139.

In group 3) belongs a belt-set excavated in grave 285; the large strap-end and the belt-plate of the hinged buckle are decorated with human heads.

That belonging to group 4): belt-ornaments decorated with felur-de-lis motif in openwork yielded by grave 111.

Besides those enumerated above there were graves which yielded 1–2 mounts or only a single strap-end. Such were graves 20, 143, 145, 168. Out of those listed above graves 20 and 145 were found disturbed (plundered). Grave 143 only yielded a strap-end, a belt-loop and a propeller-shaped mount and grave 168 a single strap-end cast in bronze.

Belts decorated with cast bronze belt-ornaments, besides buckles and large strap-end were usually furnished with 3–4 small strap-ends, mounts to embellish the pendent straps, their numbers being 3, 4, 5 times the numbers of the small strap-ends. Further mount-types belonging to the belt-sets were propeller-shaped mounts, belt-loops and belt-hole guards. Among those discussed above, from the belt-set of grave 140 the large strap-end is missing; graves 139 and 204 have not yielded buckles; graves 35 and 53 have not preserved belt-loops not propeller-shaped mounts.³⁷

1) The greater part of the belts decorated with cast bronze belt-ornaments of the Avar Period appears to belong into group 1. In spite of the type of the flat-leaves, the type of the tendrils, the border-design of the strap-ends and the decoration of the strap-fasteners showing a rather great variety, the concept of the flat-leaf tendrils is uniform. Among the belt-ornaments excavated in graves 35 and 152 the flat-leaf tendrils on the large strap-ends are surrounded by scalloped borders. The strap-ends of graves 53, 130 and 140 have plain framings. The large strap-end of grave 214 shows a pearled border. The mounts for the pendent straps are losenge-shaped and of the openwork type: those found in graves 35 and 53; the pendent straps were adorned with shield-shaped mounts in graves 130, 140, 152, 214. The mounts for the pendent straps of the belt yielded by grave 152 show engraved palmette motifs against a punched background, the cast front-plate of the belt-loop bears a plant pattern of „foliate-florous scroll” type with large, lobed leaves (a variant of the „palmette” motif).

2) The large strap-ends of the belts belonging to this group are embellished with plant patterns of foliate-florous type or pairs of tendrils arranged about a single or two axes. The globular leaf pattern often occurring in cases of punched backgrounds here emerges in a cast form. The plant pattern of the large strap-end excavated in grave 38 is surrounded by a scalloped border, that on the item of grave 124 is depicted inside a double wavy line and beading-like border; a rope-like border-design occurs on the strap-end of grave 139.

3) The narrow sides of the large strap-end, the surfaces of the buckle-loop and tongue as well as the propeller-shaped mount discovered in grave 285 have engraved palmette decorations against punched back-grounds (Fig. 4).

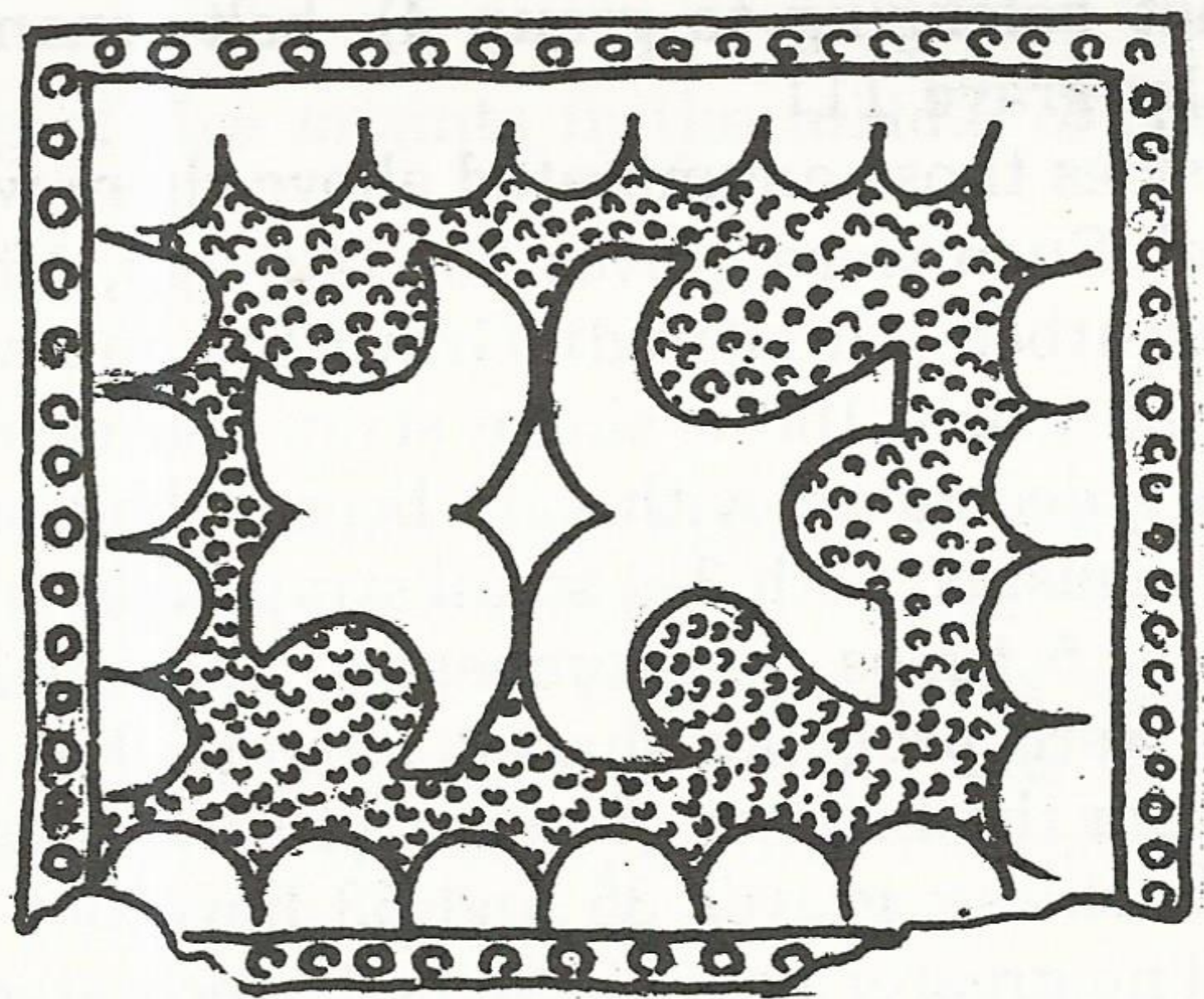
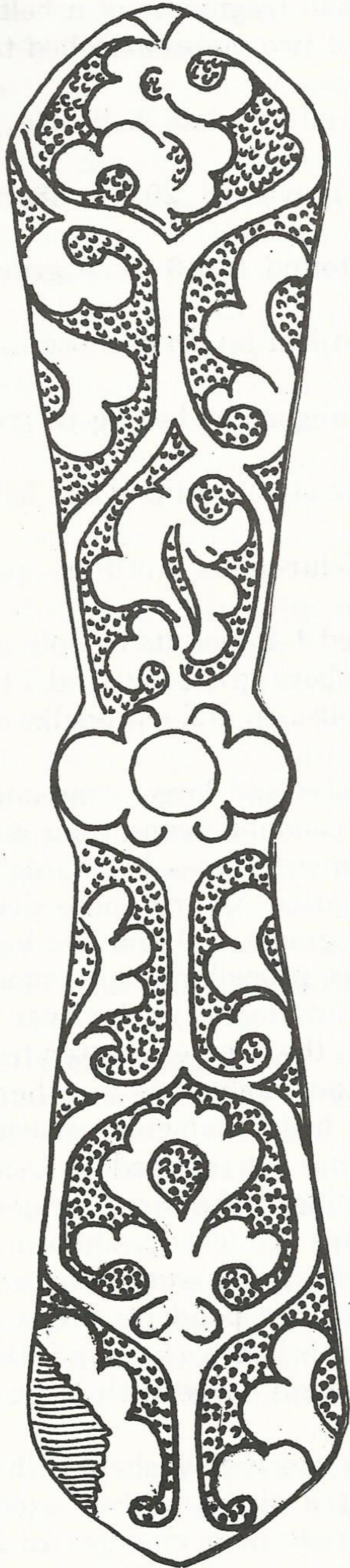

Fig. 4. 1-2 Decoration of the mounts in grave 285 enlarged

4) The fleur-de-lis motifs on the large strap-end yielded by grave 111 are surrounded by a scalloped border; a cast variant of a tripartite leaf motifs is found also here.

Among the graves in which belts ornamented with cast bronze mounts were found, in grave 35 a single penannular earring, from graves 111 and 124 two earrings of the same type were recovered. Graves 34 and 111 yielded hand-made pottery vessels; in graves 130, 143, 152 and 285 were wheel-made yellow vessels excavated (bottle: graves 130 and 152; jar with handle missing: grave 143; mug with handle: grave 285).

Among the mount-decorated belts those in graves 124 and 285 were placed on the dead bodies after they having been deposited in the graves. This custom was mentioned earlier.³⁸

Belt-ornaments decorated with human heads came to light in graves 23, 214 and 285. The outlines on the front-plate of the belt-loop of grave 23 are hardly discernible any more. Female portraits depicted „en face” occur also on Byzantine buckles.³⁹

The decoration of the large strap-end of grave 285 consists of four human heads, each depicted in medaillon form, three in profile, one full-face; the belt-plate of the buckle coming from the same grave shows two confronting human heads.⁴⁰ The mounts for the pendent straps recovered from grave 214 are embellished with a schematic human figure. In addition to the engraved figure on the Jánoshide needle-case the spindle-whorl of one of the Szekszárd Palánk graves are adorned by schematized human figures.⁴¹

Bronze buckles as „second buckles” were found in three male graves: 35, 130, 152.

Iron buckles were yielded by 48 male graves. The total number was 63. 19 graves contained two, one grave three of them. The iron buckles are as a rule, quadrangular or oblong-shaped, partly with incurved sides; seven buckles are trapezoid in shape a small circular, a D-shaped and three oval-shaped specimens were additionally found. The buckles are somewhat larger in size than those found in female and children's graves. Iron buckles were often applied as buckles of mount-decorated belts but they might fasten a second belt belonging to the attire. Second and third belts were used to fasten trousers and underclothing. A purse and an iron strike-a-light were often suspended from them.

Hairplait-ornaments were excavated in two graves. Grave 75 there were two plain bronze plates of small size, in grave 314 two oblong-shaped ornaments showing interlace patterns and embossed dots of repoussé were found.

Earrings were recovered from the following male graves. Graves 180, 293 contained silver earrings with medium-sized globe-pendants; in graves 34, 83 and 248 were bronze earrings with glass bead-pendants. The large hoops of the earrings found in grave 305 were probably decorated with several beads; their pendants belong to the cone-frustum type with glass bead. Earrings with globular metal pendants were found in such graves in which belts decorated with repoussé belt-ornaments were found, whereas earrings with glass bead-pendants were preserved in graves yielding plate belt-ornaments. The same graves, as a rule, also contained weapons. Earrings came to light both as single pieces and pairs.⁴² A single earring was found in graves 180 and 248, pair of them in graves 293, 34, 84, 305. Penannular earrings were recovered from graves 23, 35, 58, 61, 124, 179. Graves 23, 56, 61, 179 contained belts decorated with mounts of metal plate, those in graves 35 and 124 by cast bronze belt-ornaments.

Two glass *beads* were found in grave 83: one segmented bead and a black one with yellow plastic ornamentation (trailing).

A *finger-ring* came from grave 111. Pieces of similar shapes have been known as pendants of belt-mounts.⁴³

A *Roman coin* was found in grave 180; it came from an unknown position. In grave 102 the coins were deposited enclosed in a purse near the left hand.

A *bronze rattle* was excavated in male grave 18, it had been suspended from the belt.

(b) The *female graves* contained *iron buckles* indicating the presence of a belt in about every second case (65 graves). The pieces are mostly oblong in shape yet such with incurved sides, oval and trapezoidal shaped ones also were recovered. In the female graves usually a single buckle turned up. Two buckles were found in ten graves (50, 54, 62, 67, 184, 256, 272, 280, 287, 296); three of them in two graves: 259, 286. In grave 259 two buckles were found within the pelvic area, the third came from an unknown position; in grave 286 one of the buckles occurred under the left ilium, the others came to light within the pelvic area. In these graves one of the buckles was used for suspension, the other two to gather up the garments. Among the iron buckles that of grave 14 is conspicuous by having an additional iron belt-plate.⁴⁴ Iron buckles are met with

in graves of people of rank and common people alike, they were not characteristic of the graves of the poor.

Earrings have been recovered from 67 female graves that is, roughly in every second grave. The earrings were found by twos in every case, and their type was equally identical. By their shapes and decorations the earrings were assigned to the following types:

- earring with metal globe-pendant;
- earring with globular glass bead-pendant of large size;
- earring with large pyramidal pendant;
- circular earring with glass bead-pendant;
- earring with pendant made up of a cylindrical or cone-frustum type setting and glass bead (a) or hollow metal mead (b);
- earring decorated with several beads;
- oval earring with glass bead-pendant and pseudo-granulation;
- penannular earrings.

1) Among the earrings found in the female graves of the Kundomb cemetery 12 items belong to this group. They may be classed in further groups or subgroups by the sizes of the globular pendants⁴⁵ thus:

- a) with large, b) with medium-sized, c) with small pendants.

To type-group a) belong the earrings coming from graves 9, 255, 283, 284; to type b) graves 63, 79, 85, 213, 280, 281; to type c) the items found in graves 8, 308. The earrings recovered in grave 297, though having globe-pendants represent a special type, namely that in which the globe-pendant is fastened to the earring through a cylindrical attachment bit.⁴⁶ Out of the 12 graves belonging to the first group eight graves also contained many-coloured beads.

2) Five graves, namely 117, 290, 291, 296 and 307 belong to this type. The large globular glass bead-pendants are of various colours, blue, black and white among them. The specimens with pendants of watery green colour is absent in the material of the Kundomb cemetery. Only one of the graves containing earrings of this type yielded many-coloured beads (grave 291); in two graves 117 and 296 there were small segmented glass beads.

3) In grave 262 a pair of earrings with large-sized pyramidal pendants was excavated. The openwork pyramidal pendants were made of gilt-bronze plates. The type of the pendant is unique, adorned with a large globe and three smaller ones on the apex; the hoops of the earrings got lost. At the meetings of the sides there are tripartite ornamental buttons. The deceased was deposited upon an ashy layer and the skeleton equally shows traces of burning. The earrings were found in the filling of the grave.⁴⁷

4) The earrings classed in group 4 came from graves 22, 44, 72, 265, 274. In grave 265 a few bossed beads, in graves 22 and 44 melonseed-shaped beads, in grave 274 milletseed-like beads were found.

5) The earrings excavated in graves 12, 15, 54, 74, 87, 249, 251 belong to this group; the type 5b is represented by the earrings found in grave 251. These graves had no strings of beads.

6) The earrings of graves 36 (?), 49, 54, 62, 65, 74, 108, 114, 226, 227, 246, 247, 264, 267 and 277 are classed in this group; most of them are incomplete. Some of the graves yielded melonseed-shaped and milletseed-like beads.

7) This group includes the majority of the earrings they came from graves 40, 108, 112, 114, 135, 142, 149, 153, 156, 175, 198, 205, 212, 217, 237, 248. In about half of the graves melonseed-shaped beads, in the other half black beads with yellow relief trails were found. Among the beads recovered from grave 175 an „eyespot-bead” (Kreisaugenperle) in blue-white was found.⁴⁸ The bead-pendants of the earrings: polyhedral („cornless cube”) types (40, 108), drop-shaped ones (112, 142), truncopyramidal (156, 198) and small-sized globular (149, 212, 237) in shape. This latter pendant type is unaccustomed with this sorts of earring.

8) Such earrings were automatically classed in this group as could be supposed that the pendants were missing also at the time of the burial or were later reduced to dust. Under such condition the number of the items belonging to this group could not be evaluated numerically.

In addition to those discussed above two types of earrings should be mentioned: grave 104 yielded two oval earrings each with a large bead strung on the hoop; from grave 199 was an fragmentary earring recovered, its cluster-like decoration was made up of globules. The latter was perhaps a fragment of a star-shaped earring.

Beads were unearthed in the Kundomb cemetery only in small quantities: not more than in 1/3 of the graves. Not only that beads were present in a few graves only, but the numbers of beads that came to light were also rather small. The presence of strings of beads could only be assumed in a few cases: two strings of beads were recovered from the grave of a child (17: grave of a little girl). The string were made of melonseed-shaped beads. Such composed of milletseed-like beads were seldom unearthed. The beads recovered in the Kundomb cemetery can be assigned to six types:

1) Bossed beads of various types came to light in graves 63, 79, 280, 283, 284, 291, 308, 319 (large, many-coloured types were recovered from graves 283, 291 and 308)

2) Milletseed-like beads of blue, yellow, black and brown colours were found in graves 8, 54, 56, 108, 136, 205, 227, 247, 259, 264, 265, 274;

3) Segmented beads were in graves 63, 117, 128, 175, 176, 296.

4) Black beads with plastic ornamentation (trailing, „muffs”) in yellow were found in graves 136, 149, 153, 156, 161, 169, 175, 176.

5) Melonseed-shaped beads, as a rule, of light blue, green and yellowish green colours turned up in graves 3, 5, 13, 40, 42, 44, 46, 48, 49, 50, 56, 108, 112, 114, 136, 142, 154, 156, 161, 205, 212, 227, 228, 247, 267, 319.

6) Diverse beads represented by 1–2 specimens were classed in this group: polyhedral beads (graves 142, 154, 173, 176) and dotted beads (graves 63, 136, 205); the „eyespot-head” coming from grave 175 of significance also for the chronology and for commercial rapports at those times. Some beads made of chalk, calcedon beads and stone ones of „axe-head type” were found in grave 236. Grave 213 yielded rock-crystal beads, graves 104 and 136 globular silver beads. In three graves: 175, 227 and 308 small discoid beads were found.⁴⁹

In some of the graves yielding beads also small iron ringlets (chain-links) were discovered.⁵⁰ Such were in graves 63, 161, 291. Graves 63 and 291 belong to the early burial phase within cemetery, having yielded an earring with metal globe-pendant and that with a large globular bead pendant. In grave 161 a bronze bracelet of rectangular section and black beads with yellow relief trails were brought to light.

In grave 227 a cylindrical silver *amulet case* decorated with three ribbed silver bands and furnished with an attachment-loop was found. The piece was suspended from the string of melonseed-shaped beads.⁵¹

Breast-clasps were recovered from graves 44, 48, 108, 227, 310. They were made of bronze and, except for the clasps found in grave 44, they were of identical type and dimensions: of 2,7–3 cm diameter. They belong to the eight-petalled rosette type. They invariably occur by twos, at the side or under the sternum or the skull. The pair of breast-clasps in grave 44 differs from the rest not only by its dimensions (diameter) but by its ornamentation. Though being of the type with glass inlay, the cells are of various shapes; the central blue stone, highly elevated, is surrounded by light green glass plates placed in trefoil-shaped bronze cells in a step-like arrangement.⁵² No similar object is described in Hungarian literature.

Bracelets were found in 17 graves; they were usually worn by pairs. In a single grave (9) were three of them found. Another grave (63) yielded a single bracelet.

By their materials the bracelets fall into two groups. Bronze ones, recovered in 13 graves, and 2) such made of iron, found in 4 graves. 1) The best part of the *bronze bracelets* are circular in section, with slightly thickened terminals. Such pieces came to light in graves 9, 40, 49, 112, 141, 154, 205, usually together with oval earrings and strings of melonseed-shaped beads. Among the bronze bracelets of grave 9 the third bracelet made of bronze plate with rounded terminals catches the eye. — Bracelets of rectangular section were found in graves 161, 212 and 246. In grave 161 yielded a string of black beads with yellow relief trails. In grave 212 a string consisting of melonseed-shaped beads turned up. The two bracelets of grave 288 was made of thin bronze wire, their terminals pointed. The cast bronze bracelets unearthed in grave 108 is a rarity: cast bronze bracelet composed of four part interconnected by hinges. The two bigger parts, slightly bent, are tendril-decorated, the two smaller part, show a forward-gazing griffin. The design and execution of the tendril ornament are also similar to the technique of the large strap-end found in grave 18.⁵³ The *iron bracelets* are circular in section and extremely fragile. They came from graves 63, 153, 284. The iron bracelets yielded by grave 56 is of the twisted type.

Among the graves containing bracelets 9, 63 and 284 belong to the early burial phase within the excavated area of the cemetery. The bracelets were discovered together with single (non-strung) beads and earrings with large metal globe-pendants.

Finger-rings were recovered from graves 40, 212, 227, 259, 291. Grave 40 yielded a thin bronze finger-ring made of bronze wire, with bezel formed by a spiral. A penannular silver finger-ring was found in grave 259. Finger-rings „with stones” were found in graves 212 and 227. The circular bezel of the finger-ring in grave 212 was set with big blue bead, and the middle of the hoop was adorned with a big blue glass bead, and the middle of the hoop shows pseudo-granulation. In grave 227 two finger-rings made of silver of poor quality, with circular bezels set with green glass, were recovered. Grave 291 yielded a silver finger-ring with „rosette-bezel” of repoussé set with glass inlay in the middle. This was the only one among the graves containing finger-rings that belonged to the early burial phase within the cemetery.⁵⁴ The grave preserved an earring with large globular bead-pendant and a string of beads consisting of manycoloured bossed beads.

The presence of *headdress* was suggested by repoussé silver plates found in two graves. In grave 247 only tiny plate fragments have survived in the region of the left shoulder. Grave 281 yielded four rectangular plates decorated with interlace pattern in repoussé,⁵⁵ they came to light in the region of the left shoulder.

A *comb* was recovered in grave 10. The double-row comb had a slightly convex reinforcing plate decorated with hexagonal prisms standing on their edges, finely cut with double lines.⁵⁶

The presence of *toilet applicances* was indicated by a pair of iron tweezers found in grave 291 and by the fragmentary bronze spoon bearing perforations; the latter was found in grave 308.⁵⁷ Both graves yielded disc-shaped spindle-whorls, and bossed beads; in grave 308 and earring with metal globe-pendant was found, grave 291 yielded a specimen with large globular bead-pendant.

Purse. No leather nor textile remains to suggest the existence of a purse were found in the female graves, though the position of some grave-goods often pointed to the existence of purses or small pouches fastened to the clothing or carried in a pocket.

Coin. A small Roman bronze coin heavily worn was recovered from female grave 272, under the pelvis of the skeleton.

(c) *Children's graves*. *Iron buckles* were found only in every third grave, that is, in 11 graves. The buckle yielded by grave 218 is oval in shape, in grave 219 a D-shaped specimen was excavated, grave 254 contained an oval and an oblong iron buckle; two circular items were found in grave 25. The dimensions of the iron buckles did not differ from those recovered from female graves.

A *bronze buckle* with iron tongue missing was found in the grave of a female child (grave 24); the oblong buckle originally used probably for a purse, occurred below the pelvis.

Earrings. Those found in graves 79 and 254 are circular specimens with a metal globe-pendant each. Oval earrings were recovered from graves 135 and 270. Both graves just mentioned also yielded breast-clasps of rosette type. Penannular earrings came to light in graves 14, 27, 97 and 116.

Beads. Bossed glass beads were found in grave 79, milletseed-like beads in grave 17 and 116; one segmented bead was found in grave 116; melonseed-shaped beads came to light in graves 6, 14, 24, 33, 116, 144, 225, 270. Strings of beads primarily came from children's graves (small girls). Grave 17 yielded two strings of beads, one consisting of milletseed-like, another of melonseed-shaped beads. A cast crescent-shaped *pendant* (lunule) was suspended from the string of milletseed-like beads.⁵⁸ Among the beads lying on the sternum in grave 116 there was a narrow *bone plate*. Some of the graves (144, 225, 254) contained small iron *chain-links* among the beads and one grave (79) yielded two plates from an iron *plait-armour*.

Breast-clasps were excavated in graves 135 and 270. Breast-clasps of two different types were found in both graves, one of the eight-petalled rosette type, another adorned with four „petalls” and triangular cells, made of gilt-bronze.⁵⁹ Oval earrings were found in both graves; grave 270 yielded a string of melonseed-shaped beads and a reddish wheel-made pottery bottle.

A pair of bronze *bracelets* of rectangular section was recovered from grave 24. Iron bracelets came to light in graves 97, 120 and 311.

An oblong-shaped *bone purse-fastener* came from grave 116;⁶⁰ its decoration consists of dotted circles. In the same grave a stick head carved from bone and a narrow bone plate with two perforation were found.⁶¹ Another purse-fastener was found in child's grave 299; oblong bone plate showing dotted circles, incised geometrical and „amorphous” motifs.

Grave 298 contained two *oblong bone plates* decorated with dotted circles. In addition to this decoration the objects bear further decorative elements: arched lines engraved at both narrow ends and a small lozenge of double contour.⁶²

Iron rattles came to light in graves 25 and 224. Grave 25 contained two iron rattles, the way of their suspension seems easy to reconstruct: the rattle was suspended by means of a small ringlet and fixed to a strand of wire cleft into two parts. The sounding pebble is still enclosed the rattle. In grave 218 there was a *bronze rattle*, found under the sacrum of the skeleton, together with a conical bone object with an incised all-over decoration, truncated cone in shape; (Fig. 3. a-d); both ends of the bone object were transversally perforated.⁶³

Roman *coins* were unearthed in grave 24: fragmentary small bronze coins impossible to determine. The coins were deposited „on the shoulder” of the deceased.

2. Tools, implements

(a) *Male graves.* *Iron knives* are the most frequent grave-goods of Avar graves. In the Kundomb cemetery 80 per cent of the male graves contained iron knives. The knives fall into two groups according to their sizes. 1) Those of everyday use, their lengths between 10 and 18 cm and 2) those over 18 cm long, sometimes of a length of 25 cm. The knives belonging to the second group are alternatively called daggers.⁶⁴ Generally speaking the terms „large” or „long knives” appear to be more adequate, as the shapes of the blades correspond to those of knife of smaller size, and they had been made for cutting, not for stabbing. Among the knives belonging to the first typegroup there are some of still shorter lengths, even below 8 cm, such as those found in graves 209 and 316. The widths and shapes of the blades also determine their functions: in the Kundomb cemetery knives with narrower blades, and also wider than average were found. According to the excavation record knives were mostly found in the region of the right hand and they had been suspended from the right-hand side of the mount-decorated belts.⁶⁵

Iron rings of medium sizes, 3-4 cm in diameter often occurred in the proximity of the knives (as in graves 52 and 252) or else, they were used as suspension-hoops for irons strike-a-light, knives etc. In certain other Avar cemeteries larger beads were found near the iron rings,⁶⁶ these beads probably ornamented the suspension straps for the knives. Unfortunately iron rings are extremely fragile and often become misshaped.

Iron strike-a-light and flints were found in rather few graves of the Kundomb cemetery. In some graves, e.g. in 13, 38, 42, 80 there were only flints. From several fragments it appears that iron some of the fragments were used to strike fire. The irons strike-a-light are of the customary shape: broader in the middle and tapering towards the recurved terminals, as used until quite recently. Irons strike-a-light and flints were generally found side-by-side indicative of being originally enclosed in a pouch, a purse or a pocket,⁶⁷ for instance in graves 38, 83, 102, 180. They usually were found at the right-hand side, next to the knives. It has been observed that in such graves as contained belt-ornaments the iron strike-a-light and flints were kept in a small pouch or purse suspended from the left front part of the belt.⁶⁸

Whetstones were found only in a few graves. Though they were probably kept permanently at hand to whet knives and other tools, they were seldom found in the graves.⁶⁹ Their find spots in the graves varied similarly to their shapes and sizes. They were usually made of sandstone. The whetstone found in grave 275 of the Kundomb cemetery was perforated through the centre and suspended beside the disentangling hook coming to light in the same grave.

Disentangling hooks made of antler were discovered in eight graves: 76, 80, 179, 266, 275, 276, 305 and in boy's grave 299. Most of these graves contained belts decorated with plate belt-ornaments. The item found in grave 76 shows dotted circles as decoration, though these tools, as a rule, are undecorated. Among the disentangling hook of the Kundomb cemetery specimens with two holes each were equally found. It is generally believed that these holes serves for the suspension of the tool,⁷⁰ but the possibility that they were used for attaching a handle to this tool should also be considered. Disentangling hooks made of antler were found in the proximity of the irons-strike-a-light and flints.

Besides disentangling hooks to the *implements of antler* belong a two-pronged object excavated in grave 58; it was found under the bones of the right forearm. Such tools were commonly used to perforable leather.

A *bone object* used probably for polishing was found in grave 75 among the phalanges of the right hand; similar item yielded female grave 87.

Needle-cases were usually deposited in female graves. Also male grave 61 contained a needle-case of turned bone.⁷¹

A *sickle* was recovered from grave 101. Its function in the grave has not been clarified yet i.e. whether it was a tool or whether it was deposited in the grave in accordance with the burial rite. Sickles were usually found in female graves.⁷²

A tool typical of the graves of the early burial phase within the excavated part of cemetery was a „hoe” (tool for woodworking); it was found lying on the upper part of the right femur.⁷³

(b) *Female graves*. *Iron knives* were also often found in female graves, in 40 per cent of so of the cases. The knives belonged to the short type. No long knife was discovered in any female grave.

Iron rings were mostly found in female graves, in the same positions in male graves, e.g. in graves 249 and 259.

Clay *spindle-whorls* were discovered only in female and girl's graves. The tools are to be classified in three types: 1) flat disc-shaped, 2) globoid and 3) biconical ones. Disc-shaped spindle-whorls were almost exclusively recovered from the graves belonging to the early burial phase; whereas biconical ones usually came from later burials within the excavated area. The spindle-whorls of type 1) were often made of body sherds or of the bases of smaller vessels, e.g. those from graves 2, 79, 85, 93, 104, 117, 255, 264, 265, 281, 283, 284, 287, 294, 308. Only three spindle-whorls were produced from materials other than pottery namely those from graves 272, 277, 296. The spindle-whorl found in grave 283 was carved from a late-Roman glazed pottery vessel of greenish-yellow colour.⁷⁴ The grave yielded silver earrings with globe-pendants, multi-coloured bossed beads, a bronze mount of multi-petalled rosette type, a hand-made pottery vessel and Scythian earring.

Type 2) globoidal, was represented by a few specimens only: graves 213, 319, 226, 237, 249, 312. On the piece found in grave 226 traces of red paint could be discerned.

The majority of the spindle-whorls belongs to type 3): graves 3, 10, 12, 15, 22, 36, 40, 42, 44, 46, 48, 50, 62, 63, 65, 74, 87, 100, 135, 142, 149, 154, 156, 169, 176, 212, 218, 234, 246, 297, 307. The spindle-whorls were, as a rule, decorated with incised ornaments or concentric ribs; one of the pieces shows stamped dots (grave 65).⁷⁵

Incised and carved decorations were incrustated in several cases, e.g. that in grave 234. This spindle-whorl differs from the others also by its size and way of decoration covering all its surface.

Bone *needle-cases* are among the most frequent finds in female graves. In the Kundomb cemetery only cylindrical needle-cases of turned bone were found.⁷⁶ They are, as a rule, of the same dimensions: length 7–9 cm, width 1–1,3 cm, the only exception being the needle-case from grave 286. This needle-case might have been the handle of a knife. Its diameter measured 2,8–3 cm. The needle-cases are of circular cross-section, but also a few of oval-cross section. The pieces were ornamented on a lathe,⁷⁷ their decoration showing many variants, defined by the zones of the ribs and the numbers and widths of the zones of „balls” between the ribs. As regards the needle-cases recovered from the graves 54, 142, 154, 173, 236, 280, 281 of the Kundomb cemetery, the decorations differ from those of the graves 54, 142, 154, 173, 236, 280, 281, where as those of graves 54, 154, and 236 are matching. Some needle-cases were ornamented otherwise than by turning: by incisions with a knife (grave 281). The needle-cases from graves 142, 236, 281 still contained iron needles.⁷⁸

Awls made of antler yielded two female graves: 87 and 284; in grave 87 it was found together with a *bone object* for polishing inside a small pit deepened into the grave-floor.

(c) *Children's graves*. *Iron knives* were also found in children's graves, though the finds could not be recovered intact, but crumbled to tiny fragments. Knives were found in graves 66, 73, 116, 135, 151, 155, 212, 218, 219, 224, 245, 263, 299.

Iron rings associated with knives were found in graves 218, 219. Iron rings were recovered from several graves the finds, however, have either not survived, or have to be reconstructed from too tiny fragments. Their positions in the graves are mostly uncertain.

Spindle-whorls were recovered from graves of young girls 45, 135 and 212. All the spindle-whorls are biconical in shape.

A *needle-case* was discovered in the grave of a child (or young girl); it was made of a smoothed calicular bone.

An *awl* made of antler was excavated from grave 299, of a boy (cf. male graves).

A *stick head* of bone was excavated in grave 116. The oval-shaped piece was laterally perforated.⁷⁹

3. Weapons

In the Kundomb cemetery were only a few weapons excavated.

A *sword* was unearthed in grave 180. The straight double-edged blade was 96 cm long,⁸⁰ yet being fragmentary and covered with adherent wood fibres the width of the blade could not be ascertained. It is, however, sure that the sword belonged to those of rather broad blade. At the two surfaces of the blade, rust and wood remnant deposits add to the thickness of the blade (upon the same side); probably the attachment lugs of the scabbard were fastened at these points.⁸¹

Bows were found in three graves of the Kundomb cemetery. A complete bow was buried in grave 180; its terminals were furnished with narrow bone stiffeners of early type.⁸² Its find spot in the grave was recorded by a photo taken at the time of the excavation. In the other two graves: 34 and 300, only a bone plate for the grip in each has survived. The type of the bows could not be determined because of their fragmentary state of preservation. The sets of repoussé belt-ornaments found in all three of the graves indicate an early burial phase within the cemetery.

Arrowheads were recovered from grave 180 mentioned above: two small-sized trilateral pieces.

The single *spearhead* of the cemetery was excavated in grave 293. It is 36 cm long, of the shape of a flattened willow leaf, the blade of a losange section, the socket narrow-necked.⁸³ The grave also yielded a Környe-type belt.

Axe. An iron-axe was found in grave 148. Unfortunately its shape cannot be but guessed, the find being incomplete; it probably was with straight back and vertical cutting edge.

Large-sized (long) knives were usually found in the same graves with belts decorated with cast belt-ornaments.

4. Pottery

Among the 316 graves of the Kundomb cemetery pottery vessels were found in 52. There are cemeteries in which much larger quantities of pottery were unearthed, whereas in others no vessels were buried at all. The 52 vessels came to light from 49 graves. Two pottery vessels were found in each of three graves: 63, 143, 291.

The pottery vessels may be assigned in two large groups: 1. hand-made vessels; 2. wheel-made vessels; 3. two Sarmatian wheel-made grey vessels were unearthed in graves 57 and 75.⁸⁴

1) Hand-made pottery vessels were found in graves 3, 10, 38, 41, 44, 63, 73, 76, 79, 81, 85, 86, 87, 90, 92, 95, 98, 104, 111, 116, 127, 180, 201, 231, 248, 254, 263, 272, 277, 281, 280, 283, 291, 300, 304, 307 and 308 (?). Among the hand-made vessels the one found in grave 44 excels by its type, the pot has a strap-like carrier-handle; wheel-made vessels of similar type are often found among the material of Sarmatian settlements.⁸⁵

The Kundomb vessel is made of refined yellowish clay, its body shows a painted decoration consisting of vertical black stripes. Another hand-made vessel of similar colour and material came from grave 307. It is a bottle with bulging body and with a slender neck. Such shapes seldom appear in the Avar cemeteries.⁸⁶ The pot of grave 41 belongs to the two vessels just discussed by its material. The rest, as a rule, pots of larger or smaller sizes, mostly with slightly everted rims. Some of the rim-edges show finger-impressions or vertical slashings as decoration. The body of the pot coming from grave 95 is decorated with an impressed design of woven material.⁸⁷ The hand-made pot yielded by grave 43 has quadrangular mouth.⁸⁸ Several small-sized hand-made vessels were recovered from children's graves 79, 92, 254, 304.⁸⁹ The rims of these small oval-bodied vessels are slightly everted (such was also the vessel unearthed in grave 54, lost). The pot excavated in grave 116 has a torus-like pedestal foot: it represents a special type.⁹⁰

2) A distinct group of wheel-made pottery includes yellow vessels made on kick-wheel.⁹¹ Six such pieces were excavated in the Kundomb cemetery. Those found in graves 143, 148,⁹² 169, 285 are mugs with handle, that in grave 152 a bottle, a bottle with horizontal fluting along its belly was found in grave 130. Except for the mug with a handle recovered from grave 143 all yellow vessels show remnants of painted decoration. The medallion ornament on the bottle of grave 130 can be interpreted with certainty since the publication of the Székkutas vessel by Katalin Nagy: its ornament represents wild-boar heads depicted in medallion forms.⁹³ The painting

was best preserved by the mug coming from grave 148, the individual fields are filled with plant ornaments. Yellow pottery vessels turn up in male and female graves alike.⁹⁴ In male graves 130, 152, cast belt-ornaments decorated with flat-leaf tendrils, in grave 285 a cast belt-set with a large strap-end decorated with medaillon-forms were found. The belt-loops from graves 152 and 285, as well as the mounts for the pendent straps show palmette decorations against a punched background. In the female graves black beads with yellow relief trails (grave 169) as well as glass beads of various types (grave 148) were found. Grave 143, in addition to a mug with a handle, also yielded a wheel-made jar, brick-red in colour. The wheel-made bottle of the same colour, coming from grave 270, is decorated with horizontal grooves on its belly and below its neck; it is a thick-walled heavy pottery vessel. In the grave breast-clasps of bronze-gilt, a string of melonseed-shaped beads, a pair of earrings with glass bead-pendants and a clay spindle-whorl were preserved.

In grave 248 a small bronze-mounted box was deposited. A similar object was excavated in the Kiskőrös cemetery.⁹⁵

V. SUMMARY

The excavation report of the Szeged Kundomb excavations fails to state whether there were any parts in the cemetery left unexplored.⁹⁶ Though the grave-finds yielded by the graves suggest a continuity of the burial phases, it seems likely moreover that we have obtained information only from a part of the burial ground. Unfortunately there is no cemetery plan in hand, and therefore, in summing up the data of the graves we are reduced to have recourse to the archeological material. As regards the interrelations of the graves that is to say the topographical pattern of the burials we only know that the excavations were made plot by plot, so the numbering of the graves might reflect a certain topographical distribution within the excavated area.⁹⁷

The sketching of the character of the Kundomb cemetery will be approached from two angles: 1) the burial rites, and 2) the chronological pattern of the excavated area of the cemetery and implications concerning the social structure of those buried, as resulting from the archeological material.

1. Concerning the burial rites in the Kundomb cemetery we consider those phenomena to be of primary importance that relate to the ceremonies preceding the deposition of the dead in the grave. As compared to other Avar Period cemeteries explored about at the same time, the Kundomb excavations offered considerably more observations, more archeological informations on this subject; such as the presence of ashes, charcoal etc.⁹⁸ Phenomena being in connection with the funeral rites can be summarized as follows. The observations that in grave 43 there was a layer of ashes, 2–3 cm in thickness, 30 cm above the skeleton and under the skeleton the grave-floor was burnt red. In grave 87, in a small pit sunk in the grave-floor bronze fragments, a polishing bone tool and a bone awl were preserved; these objects showed no traces of burning. The skeleton in grave 262 bore traces of burning, the dead was deposited upon an ashy layer containing a large quantity of pottery sherds. In the fill of the same grave two incomplete gilded bronze earrings with pyramidal pendants turned up and no other grave-goods were found in the grave. The excavator, basing his opinion on these phenomena suggests that the grave had been disturbed. We, however, might regard the position of the earrings indicating that they were cast into the fill after the deposition of the dead; as a symbolical offering or symbolical burial.⁹⁹ The ceremonies might be reconstructed like this: fire was brought to the grave from a large central „offering pit”, the dead was deposited upon the fire, then the earrings deprived of their hoops were cast in the grave pit. Without desiring to draw too far-reaching conclusions in respect of the observations regarding the burial rites we have to consider the fact that the Glodos-find equally came from a cremation burial, and that it also harboured a pair of earrings with pyramidal pendants.¹⁰⁰ Taking these observations in connection with the Avar burials as a basis we evaluate the 9 pits of about 150 cm diameter, occurring in the excavated part, in which ashes and in one of them, under a layer of snails, the shin bones of a colt and pottery sherds were found, as being the central place of the funeral ceremony. The said pits were in the vicinity of graves 190 and 197.

2. The investigations into the archeological material of the Kundomb cemetery have demonstrated that the burials began in the early Avar Period and continued without a break until the end of the Avar age. No superpositions were recorded.

The earliest chronological horizon includes such male graves as contained belts adorned by repoussé mounts: graves 102, 179, 180, 266, 275, 276, 289, 293, 300, 303, 305. Also the types of the belts deposited in graves 180 and 289 and the decoration of the mounts found in these graves are interrelated; the large strap-ends coming from these graves. The double-shield shaped belt-mounts and the shield-shaped broad small strap-ends coming from grave 180 show similar decoration: „dot-and-comma” motifs on both sides of a central lyriiform pattern. This decoration is closely related with that of the mounts of Jánosháza grave 26,¹⁰¹ Tarnaméra grave 1,¹⁰² Mezőkovácsháza grave 5.¹⁰³ Among the matrices for pressed foils the one found at Szekszárd-Palánk, a matrice for double-shield shaped-mounts, and the Adony matrice for large strap-ends show affinity with the decoration of the Kundomb mounts in question.¹⁰⁴ The decoration of the belt-mounts coming from grave 289, concave dots and „dot-and-comma” motifs, bears a strong resemblance to those of the mounts found in Deszk Sz grave 20, Fenékpusztá grave 15 and Aradac Měcka grave 85.¹⁰⁵ The Fönlak finds include matrices for manufacturing complete belt-sets bear similar patterns.¹⁰⁶ Similarly the decoration of the small strap-end of Kundomb grave 102 has its counterpart among the Fönlak finds,¹⁰⁷ whereas the ornamentation of the mount still extant is identical with the ornaments of that bearing one of the matrices found in the Kunszentmárton goldsmith's grave.¹⁰⁸ This grave contained three series of matrices for producing belt-sets of similar type. One of them is adorned by plant pattern¹⁰⁹ and is similar to the Kunágota and Tótipusztá belt-mounts of gold,¹¹⁰ as well as to the Mezőkomárom double-shield-shaped mounts (sent to the Hungarian National Museum not long ago).¹¹¹ Its composition is similar to those of the Akalan mounts and to a piece preserved in the Kiev Collection.¹¹² A belt of similar type was described by Elvira H. Tóth; it came to light in Kecskemét (Sallai Str.). As regards decoration they are related to the Adony matrice and to the belt-ornaments of Rékás.¹¹³ Belts of similar type were found at Kiskőrös Pohibuj Mackó, graves 16 and 53.¹¹⁴

The date of the goldsmiths' graves discovered at Fönlak and Kunszentmárton can be placed between the dates of the manufacturing between the Kunágota and Tótipusztá assemblages. Research assigns the Kunágota princely burial to the early Avar Period¹¹⁵ the Tótipusztá finds to the middle Avar Period, estimating it as the „top find” of the research, and even brings it into connection with the appearance of a new people in the Carpathian Basin.¹¹⁶

In grave 293 there was a Környe-type belt.¹¹⁷ Though the mounts are in a poor state of preservation, it could be stated that according to the general rules concerning these belts here there were also „pseudo-buckle mounts”. Research connects this type of mounts with the Bócsa finds.¹¹⁸ Among the Kundomb finds the earrings of grave 262 are to be connected to Bócsa: the decoration of the openwork pendants is similar to that of the strap-end-shaped mounts for the crossbar of the Bócsa sword;¹¹⁹ to this group belong also the ornamental pieces for the collar excavated in the Kiskőrös Vágóhíd cemetery, grave IV.¹²⁰

The type of the earring with pyramidal pendant decorated with cells is also known among the Szentendre finds yielded by burials of high ranking persons.¹²¹ At Szentendre these earrings came to light together with specimens with globe-pendants of large and of medium size and the burials also yielded large-sized bossed glass heads. The presence of earrings having globe-pendants is characteristic for the female graves belonging to the early burial phase of the Kundomb cemetery also: graves 213, 255, 280, 283, 281, 284, 291, 308. According to their numbering these graves were excavated in the same area as the male graves containing belts decorated with repoussé belt-ornaments. In one of the earliest graves also a spoon perforated with five holes belonging to toilet appliances was found (grave 308). Similar strainers made of silver were found at Páhipusztá, Peszér-Adács, Várpalota, Környe and Körösladány; at Peszér-Adács in complete set of toilet appliances associated with an earring with cell-decorated pyramidal pendant of large size.¹²²

The belts having many pendent straps furnished with plate small strap-ends of narrow type, graves 266, 275, 276, 279, 300, 303, 305 are interconnected, both in time and in respect to numbering of the graves to the belt adorned by repoussé belt-ornaments. The narrow belts were ornamented with flat or domed small-sized buttons above the pendent straps.¹²³ The belt of a similar construction of a grave discovered at Szegvár Sápoldal was a coin-associated find dated by the solidus of Mauritius Tiberius (582–602).¹²⁴

The greater part of the Kundomb graves yielded bone disentangling hooks, and in one of them bone plates for the grip of a bow were recovered. Grave 275 yielded an earring with small globe-pendant, grave 305 a pair of circular earrings with pendants of cone-frustum type.

Grave 64 yielded a belt adorned by „Italian-type” cast bronze mounts which assigns the grave to a last date of the early burial phase within the cemetery. Kundomb is the only site outside the Transdanubian parts of Hungary (Pannonia) where an „Italian-type” belt-set was recovered in a grave scientifically excavated.¹²⁵

The second chronological horizon is represented by male graves in which belts decorated with mounts of various shapes, quadrangular or oblong cut out of metal plates were found. Such graves are 23, 52, 58, 61, 71, 83, 314.

In addition to rectangular belt mounts a large strap-end and two small strap-ends, together with belt-hole guards generally belong to this type of belt-sets. One of them is the „Kundomb-type”, with a group of five mounts in the middle of the back. Several belts coming from the Alattyán cemetery¹²⁶ as well as the belt-set from grave E of the Kerepes cemetery belong to this group.¹²⁷ Another group of this belt-types is that of the „Alattyán type” in which the centre of the back is decorated by a triple group of mounts.¹²⁸ No such belt was unearthed in the Kundomb cemetery. None of the Kundomb belts was the same as that found in the Makkoserdő grave 24, where the back part of the belt was decorated only by a single mount with „stone” inlay. This grave yielded a solidus of Constant II and Constantinus IV (654–659).¹²⁹ The large strap-end decorated with interlace pattern, coming from Kundomb grave 23, has a connection with two Alattyán belt-sets.¹³⁰ The Kundomb grave yielded a belt-loop the upper part of which is decorated with a female half-length portrait depicted „en face”; similar figural motifs are to be found among the decorations of Byzantine buckles.¹³¹ The buckle of the belt in grave 52 was of the „Balgota type”.¹³²

The female graves dating of the same period as the male graves in which also belts adorned with mounts cut out of metal plates were buried, were rather poorly furnished. Out of the 23 graves assigned to this chronological group they only yielded earrings, in eight graves a few beads were also found. Two graves, 247, 264, contained a string of milletseed beads each, one of them a bronze bracelet of rectangular section. In these graves one or two single melonseed-shaped beads and biconical spindle-whorls were additionally found.

The third burial phase within the Kundomb cemetery comprises 17 male graves preserving belts decorated with cast belt-ornaments, namely 18, 20, 35, 38, 53, 111, 124, 130, 139, 140, 143, 145, 152, 168, 214, 218, 285. Two of them: 168 and 218 were the graves of young boys. A characteristic feature of the Kundomb cast bronze belt-ornaments is the absence of leit-motifs of the late Avar Period, that is griffins and scenes of fighting animals. The large strap-end of the belt of grave 18 is adorned with plant pattern; discoid belt-mounts belong to this belt-set. Motifs similar to those on the large strap-end are represented by the cast bracelets recovered from grave 108; a comparative material yielded the Kiskörös cemetery.¹³³ The greater part of the cast belt-ornaments is adorned by flat-leaf tendrils. One of them was found in grave 152; the mounts for the pendent straps and the belt-loop have engraved palmette decorations against a punched background. Engraved plant patterns against a punched background show the belt-loop and the propeller-shaped mount belonging to the belt-set excavated in grave 285. The belt-sets, of the same period as those of Szébény with a belt-loop each, are decorated with engraved palmettes against a punched background¹³⁴ like to the assemblages from Kiskörös 156, 158 and 165 graves.¹³⁵ The Szébény grave 100 may also be assigned to this group, and so may the belt-ornaments excavated in county Tolna, where the large strap-ends are decorated with human heads similarly to the large strap-end of the Kundomb-grave 285.¹³⁶ Among the belt-sets cast in bronze those of graves 140 and 111 belong to the latest such sets. The belt-mounts with pendants of grave 140 are of the openwork type, whereas the strap-ends coming from grave 111 are embellished with fleur-de-lise motifs in openwork.

The third burial phase in the cemetery, comprise the last burials. Graves 143 and 144 belong here. One of them yielded only a cast strap-end and in the other grave a few mounts with palmette decorations against a punched background came to light. Both of them were coffin burials.¹³⁷

Concerning the female graves that can be assigned to the last burial phase — as compared with the first group — one should be surprised by the richness of jewelry. 10 among 19 female graves yielded more than two different sorts of jewels. The graves have preserved oval earrings, strings of melonseed-shaped and milletseed-like beads, breast clasps of petalled type and bronze bracelets. Among the beads black beads with yellow plastic ornamentation appear. In grave 175 a blue „eyespot-bead” occurred. Besides grave 108 that yielded a cast bronze bracelet already mentioned, two graves deserve special attention: grave 17 in which there was a lunule pendant, and grave 227 that hid a cylindrical silver amulet case. Both objects were strung flanked by beads.

Among the pottery vessels that of grave 95, a pot decorated with an impressed design of woven material belongs to the last burials.

Conclusions:

1. As to the chronology the explored area was continuously used as a burial ground all over the entire Avar Period. The last burials took place at some date in the late 8th century or in the early 9th century.

2. According to the grave-finds, the stopping came about all of a sudden, but it will be evident from what has been said as introduction that the very last burials maybe in the areas not yet excavated.

3. The investigations into the structural questions was based on the male graves containing mount-decorated belts and female burials yielding jewels. The data yielded by these graves include the suggestion that the balance between the male and female burials belonging to the first burial phase (I) did not preserved during the second burial phase (II) of the cemetery; the number of the male graves with mount-decorated belts decreased and as far as it can be discerned from the jewels of the female graves a certain pauperization or change of the fashion may be supposed. Characteristic feature of the third (III) burial phase is the sudden increase of the numerical value of the rich male and female burials.

4. From the evidence of the cemetery plan we have come to the conclusion that the grave belonging to the first burial phase form two groups, those belonging to the second burial phase form two other groups and the same can be established for the graves of the third burial phase.

5. Some characteristic features of the cemetery must be mentioned.

a) Besides the low number of weapons they occurred only in graves belonging to the first burial phase.

b) No horse-graves or burials of horse-men came to light.

c) No hairplait-ornament can be found among the grave-goods.

D) No grey pottery vessel made on kick-wheel was deposited.

e) Concerning the belt-ornaments, no belt-sets with incised decoration and no strap-ends showing scenes of fighting animals were excavated in the cemetery.

6. Sarmatian pottery came to light in two graves (57 and 75); a Roman fibula (knee-brooch) was found in a male grave (180) belonging to the early burial phase of the cemetery.

NOTES

¹ Relatively the activity of K. Cs. Sebestyén: Banner (1957) *Arch. Ért.* pp. 221–222; Vargha: (1957) *Ethn.* pp. 170–173.

² After the discontinuation of the excavations K. Cs. Sebestyén, based on the excavation records and the sketches drawn up in the course of the excavations, processed the Kundomb cemetery. The MS contains the descriptions of the graves, gives information concerning the burial customs and lists the grave-goods recovered. The MS is completed by the sketches of the graves and the determination of the find spots of the belt-ornaments, with photos of the skeletons, as well as the photos of the finds. The latter have preserved the pictures of a great deal of objects destroyed or lost since the time of the excavations, and were in existent at the time of the excavations, and were in existent at the time of the inventoring after the World War II. Considering this a part of the missing objects is published on the basis of the old photos. The MS was never published. In 1954 K. Cs. Sebestyén appealed to D. Csallány in writing to the effect that the latter „should revise the MS preserved in the MNM as a co-author so that the work complies with the requirements. The scheme of the publication of the Kundomb cemetery prepared in 1962 by D. Csallány after the death of K. Cs. Sebestyén is known. Then further photos of the belt-mounts cast in bronze, and drawings were prepared of some objects of graves 311, 314 and 316. The work was backed by the Hungarian Academy of Sciences, Institute of Archeology. When the series „Cemeteries of the Avar Period (567–829)” started, D. Csallány was given a commission for the processing of the material, yet he could not finish the work because he died. From his estate only K. Cs. Sebestyén’s MS could be recovered. The MS does not contain any remarks, and according to the List of Contents the closing chapters are missing. In 1968 I collated the descriptions of the graves mentioned in the MS with the material safeguarded in the Szeged Museum and had the archaeological material of the cemetery sketched. Here I give the drawings showing the site of the excavations; the sections of the graves, the situations of the belt-ornaments that came to light in grave 285; the bone object found in grave 218 as appendices to the MS of K. Cs. Sebestyén (Fig. 2.). Plates XXXVI and XXXVII contain the original photos of graves. The MS of the description of the Kundomb cemetery, together with the relative archaeological material and with the photos and records taken of the excavation are in the care of the Szeged Museum.

³ Lipták–Borosné–Marcsik (1966) *Anthr. Közl.* pp. 13–16. Correction: K. Cs. Sebestyén did not carry out excavation in Kundomb in the year 1935. The excavation works were completed by Cs. Sebestyén, not by Csallány, Cf, p. 13. The anthropological processing of the material did not include the determination of the sexes and ages of the deceased in the particular graves of the Kundomb cemetery. My information concerning these data has been derived from the correspondence of P. Lipták and D. Csallány. I have used it in the descriptions of the graves. On the trepanated skull of Kundomb grave 210: Bartuch (1966) *Palaeopathology* vol. III pp. 328–330.

⁴ Csallány (1956) *Arch. Denkmäler* p. 192 No. 864, together with earlier literature.

⁵ For the kind assistance in the identification of the site of the Kundomb cemetery and relatively to the archaeological material I am indebted to B. Kürti (Szeged, Móra Ferenc Múzeum).

⁶ Párducz does not mention grave 260, only gives a description of the Sarmatian type pottery vessel *Sarmatenzeit* vol. III p. 54. In his monograph *Gepiden* p. 333 Csallány mentions the Kundomb graves 10, 64 and 260. He dated the comb recovered from grave 10 to the 8th century; he believes the cast, Italian-type bronze belt mount as being of German provenience (pl. 228) and the „hunchbacked” comb of grave 260 as being Avar (p. 252). This type of comb is characteristic for the 5th century: Salamon (1976); *MittArchInst.* pp. 50–52, with further listing of literature.

⁷ Cf. Note 2.

⁸ This type of grave is also known from the cemeteries of the Roman Imperial Period in Pannonia. In the Avar cemetery of Kerepes there were two graves with lateral niches: Török (1973) *FA* pp. 126–132.

⁹ Graves with ledges are known, for instance in the Nagyharsány Avar cemetery: Papp (1964) *JPMÉ* p. 118, Fig. 6: and from Szekszárd Palánk: Salamon (1968) p. 4; Móra (1962) *Szegedi Múzeum kiadványai* p. 5.

¹⁰ Móra (1932) *Szegedi Múzeum kiadványai* p. 7.

¹¹ Móra (1932) *Szegedi Múzeum kiadványai* p. 6.

¹² Kovrig (1963) *Alattyán* p. 78.

¹³ Roman coins that could be regarded as obols were found in four graves: 24, 102, 180, 212. The evaluation of coins coming from late Roman burials are comprehensively described by Goreczki (1975) pp. 182–446; in connection with the Szegvár-Sápoldal Avar grave, the giving of obols also in burials earlier than the Avar period; Bóna (1980) *Acta Arch. Hung.* pp. 74–91.

¹⁴ Móra (1932) *Szegedi Múzeum kiadványai* p. 10: „There were graves in which the bones of four to five fowls were found”. Unfortunately the excavation records fail to give any further explanation on this.

¹⁵ Móra op. cit. p. 10. In a few small-children’s graves entire skeletons of piglets were found. The records fail to mention this.

¹⁶ Móra op. cit. p. 10.

¹⁷ Móra op. cit., pp. 10–11 also mentions lapwing and wild-goose eggs.

¹⁸ Observations regarding the existence of „cultic places” in Avar cemeteries are very few and uncertain: Kovrig (1960) *Arch. Ért.* p. 146; Jankhun (1967) *Nachrichten der Akad. der Wiss. in in Göttingen* pp. 137–138 on the central firing place in the cemetery: p. 139.

¹⁹ There were „symbolical burials” at Szekszárd-Palánk: Salamon (1968) *Szekszárd, Palánk* p. 4. As for kenotaphs: Cs. Sós–Salamon (198) *Pókaszeptk ...* The „empty” grave pit was sunk and filled back again is only a variant of kenotaphs.

²⁰ Cf. Note 3.

²¹ Bóna (1961/62) *Alba Regia* p. 47: „einheimisch–romanisch”; Werner (1974) *Civiltà dei Longobardi* p. 219 „einheimisch–italisch”.

²² A characteristic feature of these belts is that the small strap-ends and strap-end-shaped mounts are of almost the same sizes, their differences keep below 1 cm (the strap end of grave 180 is 33 mm, the belt mount 27 cm long). According to our information this belt type is decorated with 7–8 strap-ends, 5–6 strap-end-shaped mounts and 1–3 double shield-shaped mounts. A large strap-end and a buckle sometimes also belt-hole guards belong to the belt. Csallány (1962) *Acta Arch. Hung.* pp. 473–474; Kovrig (1963) *Alattyán* p. 105; Werner (1974) *Civiltà dei Longobardi* pp. 121–139. Lately a rich burial with a belt of this type was published by H. Tóth (1980) *Acta Arch. Hung.* pp. 117–152.

²³ Adony: Fettich (1926) *Kunstgewerbe* Pl. 6, 2.

²⁴ Szekszárd-Palánk female grave 202. a spindle-whorl and the fragments of a sigillata plate were found (excavation by A. Salamon, unpublished).

²⁵ Fönlak: Fettich (1926) *Kunstgewerbe* Pl. 4, 9, 13.

²⁶ Fönlak: Fettich op. cit. Pl. 4, 18.

²⁷ Mezőkovácsháza: Juhász (1973) *Békés Megyei Múzeumi Közlemények* Pl. 3, 1–7.

²⁸ The strap-end were not decorated with silver inlays (Tauschierung). For the radiographs I am indebted to I. Lengyel.

²⁹ Kovrig (1963) *Alattyán* p. 105. On the belt type with many pendent straps decorated with small strap-ends *is not identical* with the later belts of many pendent straps decorated with wide strap-ends belonging to group 2. of the Kundomb material.

³⁰ László (1955) *Études* Pl. 44, 3–4.

³¹ Kovrig (1963) *Alattyán* pp. 124–127 on the belts belonging to the group decorated with disc-shaped belt-mounts.

³² Salamon–Erdélyi (1971) *Környe* pp. 44–45.

³³ With the first detailed analysis of the belt type: Kovrig (1963) *Alattyán* p. 128.

³⁴ Salamon (in this volume) *Makkoserdő* pp. grave 241.

³⁵ The drawing representing the find spot of the belt-ornaments allows for this eventuality. Cf. Note 30.

³⁶ The belt-sets of cast ornaments, as a rule, consist of various-decorated mounts. Seldom the excavator meets with belt decorated with belt-ornaments showing the same motifs. In their assigning to groups the mount types frequently occurring together were considered as belonging in the same category.

³⁷ On a belt decorated with cast belt-ornaments in addition to buckles and large strap-ends there are mounts with pendants in numbers of 4 to 6 x 3, small strap-ends — 3 to 6 — mounts for the pendent straps their numbers depending on those of the small strap-ends. Further ornaments belonging to the belt-sets are belt-hole guards, and belt-loops.

³⁸ In the Pókaszeptk cemetery, for instance, no belt was fastened on the dead as he had worn it: Cs. Sós (1973) *Arch. Ért.*; Further particulars on the rites and their details. Cs. Sós–Salamon (19) *Pókaszeptk ...* The custom may be observed also at other times than the Avar Period.

³⁹ Werner (1955) *Kölner Jb* pp. 40–41 on a whole group of Byzantine buckles decorated with animal and human figures. A half-length portrait of a woman, with earrings and bracelets: op. cit. Pl. 6, 7.

⁴⁰ With a summary of earlier literature: Dekan (1972) *SLA* pp. 415–419. Large strap-end with similar decorations. On the Szebény large strap-end of the same type of ornamentation of Szebény: Garam (1975/2) *Szebény* Fig. 8.

⁴¹ Erdélyi (1956) *Jánoshida* grave 226, Fig. 2 and Plate XLIV; Szekszárd, Palánk. An excavation of Author’s, not yet published.

⁴² Bóna (1980) *Acta Arch. Hung.* pp. 39–42.

⁴³ Šala (Vágsellye) – Večka: Dekan (1972) *SLA* Fig. 93 1, 3.

⁴⁴ Almost every Avar cemetery contains a few graves yielding a buckle with iron belt-plate, such, for instance, Cikó, grave 191. Hampel (1905) *Alterthümer* vol. III Pl. 210; Környe graves 34, 64, 89; Salamon–Erdélyi (1971) *Környe* Pl. 5, 8, 9, 14. The Kundomb mounts were not decorated with silver inlays. Here I say thanks to Dr. I. Lengyel for the radiographs.

⁴⁵ Kovrig (1963) *Alattyán* p. 109; Čilinská (1975) *SLA* pp. 64–66 Type I A–B. The Pókaszeptk earrings with metal globe-pendants were assigned to three groups; the chronology of the types and their interconnections have been pointed out: Cs. Sós–Salamon (19) *Pókaszeptk*.....

⁴⁶ Čilinská refuses them as belonging to a separate group or even subgroup: (1975) *SLA* Fig. 1. On the chronology of the types discussed: Cs. Sós–Salamon (19) *Pókaszeptk*

⁴⁷ For the earrings with pyramidal pendants Čilinská (1975) *SLA* pp. 67–68, type I. D. Hampel discusses the objects found in Hungary under item c); points out the Szentendre and Závod pieces as being decorated with small granules and typical: Hampel (1905) *Altertümer* vol. I. p. 357, Figs. 952, 945 and 948. We have assigned the earrings with pyramidal pendants into four groups by their differences of their production technologies, namely 1) Szentendre-type, 2) Szegvár-type, 3) Kundomb-type and 4) Závod-type earrings. The individual types may show many variants in their sizes and in other details. The latest summarizing work on the Szegvár type: Bóna (1980) *Acta Arch. Hung.* pp. 39–42.

⁴⁸ Andrae (1973) *Acta Prehist. et Arch.* pp. 130–132 on the widespreading of „Kreisaugenperlen” and interconnections with other bead types, besides the Balatonberény and Kapospula pieces referred to by the Author and we mention the beads of Halimba grave 394: Török (1969) *FA* p. 80 Fig. 5, 2 and the pieces came to light in the Zalakomár Avar Period cemetery. I say thanks to the excavators B. M. Szőke and L. Vándor for the kind permission for inspecting the finds. The same bead type, of a pretty rare occurrence, is probably likewise present also in other Avar cemeteries, yet the descriptions and drawings or photos of the beads printed in Hungarian literature do not render their identification possible. About the problem: Salamon Radan (1980) p. 38 and Note 4.

⁴⁹ The fragments excavated do not permit anything more than a hypothesis.

⁵⁰ A similar phenomenon was observed at Környe: Salamon–Erdélyi (1971) *Környe* p. 39, yet some of the graves also yielded bigger fragments of iron chain armours: Pl. 13.

⁵¹ For the antique precedents of „cylindrical amulets” cf. Facsar–Skoflek–Salamon (1977) *Mitt. Arch. Inst.* pp. 104–105, with a glance upon the Avar finds. In Alattyán grave 196 the cylindrical amulet-case was likewise inserted in a string of beads Kovrig (1963) *Alattyán* Pl. XVI.

⁵² An openwork disc of similar pattern is known from the Early Medieval layers at Eketorp: Hagberg (1978) *Eketorp*: p. 54, Fig. 35.

⁵³ A bracelet bearing the same decorations, likewise hinged, was excavated in grave 156 of the Kisköre cemetery: Garam (1979) *Kisköre* Pl. 24.

⁵⁴ For the finger-ring with a repoussé rosette-bezel yielded by grave 291: Salamon–Erdélyi (1971) *Környe* p. 40. On the interconnections of the „stone ornamented” finger-ring: Kovrig (1963) *Alattyán* p. 144; Čilinská (1975) *SLA* p. 90.

⁵⁵ For plate head-dresses ornaments unearthed in Avar graves: Horváth (1936) *Üllő és Kiskörös* pp. 62–63; Halimba: Török (1968) *ŠtV* p. 271 Fig. 3, grave 165. The head ornaments are not identical with the Stirnschmucks (Diadems) found in male graves. Cf. Bóna (1980) *Acta Arch. Hung.* pp. 36–39. Among the examples brought forward by the author from Hungary he calls the attention to the rosettes of Környe grave 78 (Fig. 4/c). The three rosettes were purse-ornaments, found together with flints and an iron strike-a-light. Cf. Salamon–Erdélyi (1971) *Környe* Fig. 35 and Pl. 12.

⁵⁶ Cf. Note 6. On the analogy of the comb cf. Daringer (1967) *JbOMV* pp. 35–36 and 37.

⁵⁷ The spoon belongs to toilet appliances. A similar silver spoon fragment was found in Halimba grave 165 referred to above cf. Note 55; At Várpalota Erdélyi–Németh (1968) *VMMK* 192 Pl. XI, 8; Juhász (1973) *Békés Megyei Múzeumi Közlemények* pp. 99–101; the author considers the cylindrical gilt bronze case found side-by-side with the toilet appliances to be a knife handle. We believe that it had been a needle-case, because in a set of the 5th century there was a similar cylindrical case which still contained needles: Salamon (1968) *Szekszárdi Múzeum Füzetek* p. 3, grave 217.

⁵⁸ Kralovszky (1959) *Arch. Ért.* pp. 76–82; Čilinská (1975) *SLA* p. 89.

⁵⁹ Earlier literature handled it as a pair of breast-clasps recovered in the Szeged-Kundomb cemetery grave 270. Yet, while processing the grave-finds it turned out that one of the two pieces of the same type came from grave 135, and the other from grave 270. The pieces still preserve the traces of gilding. The earlier publications mentioned them as being made of bronze; lately Garam (1978) *Arch. Ért.* p. 207. Under the coloured glass plates the thin bronze plates can still be distinguished; under it or between the back plate and the cells there was a piece of fabric. Garam (1978) *Arch. Ért.* p. 207 in the discussion of the newly determined necklace and appartenances preserved in MNM lists this „Igar-type breast clasp” or „disc” to which also the Kundomb pieces belong, as being closely related. Yet between the two groups there are fundamental differences. The „Igar-type” pieces belong to the group of multipartite breast-clasps and discs decorated with glass plates, whereas the jewelry published by the author have a common distinctive feature independent from character (neck-laces, breast-clasps, finger-rings) as well as the techniques of production (casting or pressing): they were decorated with strings of beads. The small loops found on the items between the border and the central part carried the strings of beads fastened upon a piece of wire. In the publication of the Üllő box-type breast-clasps and of the Dunapataj jewelry T. Horváth did not pay attention to the said arches; Horváth (1936) *Üllő és Kiskörös* p. 61 Note 16. Cs. Sós, however, in connection of the Kecel breast clasps already mentioned points out their being beads *Kecel* p. 17 with reference to Kovrig, *ibidem*, cf. Note 36. Though the beads of the pieces known to us are missing, yet Wosinszky in the publication of the graves 532–533 of the Cikó cemetery states that in the lugs of the three discs in repoussé the beads were still present. Wosinszky (1896) *Tolna megye* vol. 2 pp. 960–961, Pl. 5–6. The three discs found in the Cikó graves were parts of similar necklaces of cheaper execution than the gold jewelry lately defined by Garam and actually in the possession of MNM. This group of jewels show interconnections with late antique Byzantine metal works that adorned the pieces with beads by similar ways: for instance crescent-shaped earrings: Chatzidakis (1978) *Benaki Museum* p. 20, Fig. 7/a or the earrings whose drop-shaped members are framed by similar ornaments: Ross (1964) *Byzantine Art* Fig. 404, or the earrings that came to light in one of the Rutigliano (Bari) cemetery; their hoops show similar decorations: Salvatore (1981) *Riv. Arch. Christiana* Fig. 6 p. 138.

⁶⁰ Erdélyi (1956) *Jánoshida* p. 67; Kovrig (1963) *Alattyán* Pl. 6 grave 71.

⁶¹ Erdélyi (1956) *Jánoshida* pp. 65–66.

⁶² Bone plates of similar shapes were discovered in two graves at Várpalota. Bóna (1959) *Acta Arch. Hung.* Pl. 36, 3–4 Pl. 38, 3–4. A tentative determination of the functions of the plates in Werner (1962) *Longobarden* p. 28, Note 5.

⁶³ Móra (1932) *Szegedi Múzeum Kiadványai* p. 14; Csallány (1966/1967) *MFMÉ* pp. 61–72. The expanded drawing reproduced in our Plate 28 of a „rattle handle” was done by K. Cs. Sebestyén, Cf. Note 2.

⁶⁴ The Ürbópuszta knife may be termed as a dagger: Bóna (1970) *Arch. Ért.* p. 163; the Ivánca dagger might be said to be a long or a large-sized knife: Bóna (1970) *Arch. Ért.* Fig. 8 p. 251. On long knives cf., Szabó (1968) *EME* p. 52. Long knives keep turning up not only in the graves of the middle, but also in the late Avar Period in the Kundomb cemetery.

⁶⁵ Tomka (1972) *Arrabona* pp. 27–75.

⁶⁶ The same thing was met with in several Avar graves in Szekszárd Palánk. An excavation of the Author's not yet published.

⁶⁷ Cf. descriptions of the graves.

⁶⁸ László (1941) *Arch. Ért.* pp. 145–186.

⁶⁹ Quite a lot of whetstones were unearthed in the Pókaszeptek cemetery. Cs. Sós–Salamon (19) *Pókaszeptek*.....

⁷⁰ Probable both hypotheses are acceptable. Cf. Török (1969) *FA*: Halimba grave 174, Fig. 3, 5, 6.

⁷¹ Csallány (1939) *FA* pp. 121–180 cf. Török (1969). It was a knife handle.

⁷² Erdélyi (1975) *Ethn.* pp. 163–173.

⁷³ According to the excavation records the „hoe” had a wooden handle (shaft) and it was deposited wrapped in a piece of linen. For the tool type cf. Erdélyi (1982) *Az avarság és a kelet* pp. 154–157.

⁷⁴ The piece is worth attention because glazed pottery seldom occurs in Sarmatian regions.

⁷⁵ Several spindle-whorls decorated with impressed ornaments were found in the Szebény cemetery: Garam (1975/2) *Szebény* pp. 49–108.

⁷⁶ On the ways of production of the various types of needle-cases cf. Salamon (in this volume): *Makkoserdő* Cf. Notes 72–73.

⁷⁷ For the production methods of turned bone needle-cases: Erdélyi (1956) *Jánoshida* pp. 62–64.

⁷⁸ Móra (1932) *Szegedi Múzeum kiadványai* pp. 13–14. László (1941) *Arch. Ért.* pp. 186–191.

⁷⁹ In the Környe cemetery a bronze sceptre head found up in child's grave 133; Salamon–Erdélyi (1971) *Környe* Pl. 23 and p. 28.

⁸⁰ Csallány (1939) *FA* pp. 137–141.

⁸¹ The X-ray pictures did not display any detail. For the radiographs I am indebted to Dr. I. Lengyel.

⁸² Csallány (1939) *FA* pp. 148–150.

⁸³ Spearheads seldom occur in Avar graves. For their typology and widespreading, as well as for burials with spearheads cf. the connections with the Pókaszeptek cemetery where some graves yielding two, and even three spearheads: Cs. Sós–Salamon (198) *Pókaszeptek*

⁸⁴ Cf. Note 6. Sarmatian pottery vessels were also found in the Avar graves of the Makkoserdő cemetery: Salamon (in this volume) *Makkoserdő*..... Roman vessels seldom occur in the graves of Avar cemeteries, for instance Eisner (1952) *Devinské nová-Ves* Pl. 77 and Pl. 78; Fettich (1965) *Pilismarót Basaharc* grave 211, Fig. 122; Kiss (1977) Baranya, Gyód, Máriahegy grave 31, Pl. LXXXVIII. Cs. Sós–Salamon (19) *Pókaszeptek*

⁸⁵ Considering the pottery vessels of the same type, excavated so far we believe the vessel of grave 44 equally to be a Sarmatian vessel. Párducz (1938) *Dolg.* Pl. XVIII, 3. Fragments of wheel-made vessels with carrier handle often occur in Sarmatian material: Párducz (1938) *Dolg.* Several pottery vessels with carrier handle came to light at Tiszaföldvár on a late Sarmatian settlement; for the study of the material I am indebted to Mrs. A. H. Vaday. „Paintings” like those on the Kundomb vessel were described by Fettich (1965) *Pilismarót Basaharc* grave 62 Pl. 1.

⁸⁶ Similar pottery bottles were found also in the Makkoserdő cemetery, Salamon: (in this volume) *Makkoserdő* pp., at Csóka (Čoka) grave 40: Kovrig–Korek (1960) *Acta Arch. Hung.* p. 206 Fig. 3., and at Solt Palé: Párducz (1935) *Dolg.* Pl. XXXI, 12; in to graves in the Fiesole Longobard cemetery: V. Hessen (1971) *Toscana* p. 50. Pl. 28–29.

⁸⁷ Visznek grave 73: Török (1975) *Visznek* Pl. 37, 7–8., Szőke (1980) *Acta Arch. Hung.* pp. 185–187.

⁸⁸ For pottery vessels with rectangular mouths: Cs. Sós (1956) *Kecel* p. 20.

⁸⁹ For the small-size pottery vessels turned up in children's graves: Bóna (1968) *Studijne Zv.* pp. 40–41.

⁹⁰ Several small pottery vessels with „pedestalled bottoms” formed this way were found in the Homokmégy cemetery Garam (1951/1) *Homokmégy* pp. 11–42.

⁹¹ Bialeková (1967) *SlA* pp. 5–76; Garam (1969) *Arch. Ért.* pp. 207–241; Erdélyi (1982) *Az avarság és kelet* p. 164.

⁹² In earlier publications Horváth's work *Üllő és Kiskőrös* included the yellow jug showing painted decoration described as coming from grave 41; in reality it was unearthed in grave 148.

⁹³ Nagy (1974) *Művészet* p. 10 Fig. 55, 1. Earlier the representation had been considered by Horváth (1936) to be a griffin *Üllő és Kiskőrös* pp. 105–106; by Mavrodinow (1943) *Nagyszentmiklós* p. 33 as a dragon; by Szőke (1960) *Stud. Slavica* p. 79 as a peacock. Garam believes the drawing to picture a boar's head, basing her opinion upon the Székkutas vessel. (1960) *Arch. Ért.* p. 48, without reference of Nagy's paper. The painted medallion with black and white dots in equally found in ancient fabrics and building decorations, and the embossed band ornaments of the metal vessels are equally connected there. The recently published yellow pottery vessel found in the Avar cemetery of Pécel is adorned with painted band; Török (1971) *FA* grave 20 Fig. 4: a painted mug with a medallion was recovered in the Dunaharsány cemetery: Török (1972) *FA* grave 1, Figs. 6, 5.

⁹⁴ Nagy (1971) *RAD*. The yellow pottery vessel of grave 79 Pl. XLVI. Further yellow mugs were discovered in graves 56, 84, 78. The latter was adorned with painted medallions.

⁹⁵ László (1965) *Études* grave 42. Pl. XV.

⁹⁶ Cf. I. 1, the Chapter *The Orientation*”.

⁹⁷ Cf. III, 6 on the excavation of the cemetery.

⁹⁸ Kovrig (1973) *Alattyán* pp. 67–70.

⁹⁹ Cf. 18 and Note 47.

¹⁰⁰ Smilenko (1965) *Glodosi* Pl. III, 1.

¹⁰¹ Erdélyi (1956) *Jánoshida* Pl. 12

¹⁰² Szabó (1965) *EMÉ* Pl. 10, 2–4.

¹⁰³ Juhász (1973) *Békés Megyei Múzeumi Közlemények* Pl. 3, 1–7.

¹⁰⁴ Cf. I. 24 and Note 23.

¹⁰⁵ Deszk „Sz”: Csallány (1962) *Acta Arch. Hung.* pp. 473–474 Pl. 22; Fenékpusztá Horreum: Barkóczi (1968) *Acta Arch. Hung.* Pl. XLIII; Aradac-Mečka: Dimitrijević–Kovačević–Vinski (1962) *Seoba Naroda* p. 11, Figs. 5–8.

- ¹⁰⁶ Cf. Note 25.
- ¹⁰⁷ Similar strap-ends were found as the harness-ornaments of the Környe grave 149: Salamon-Erdélyi (1971) *Környe* p. 63. Cf. Notes 279–280.
- ¹⁰⁸ Csallány (1933) *Kunszentmárton* Pl. 1, 10–12.
- ¹⁰⁹ Op. cit. Pl. 1, 2–5.
- ¹¹⁰ Hampel (1905) *Alterthümer* vol. III Pls. 261, 268.
- ¹¹¹ Garam (1976) *FA* Fig. 1.
- ¹¹² Werner (1975) *Civiltà dei Longobardi* Pl. 7, 1–5: the Kiev matrice for a presses model: *ibid.* Pls. 1–6.
- ¹¹³ H. Tóth (1980) *Acta Arch. Hung.* pp. 117–152.
- ¹¹⁴ Török (1975) *Kiskőrös Prohibuj Mackó* Fig. 2: grave 16, Fig. 5: grave 53.
- ¹¹⁵ For the establishing of the dates of princely burial finds Garam (1976) *FA* pp. 144–145 and Note 66; Kovrig (1963) *Alattyán* p. 105.
- ¹¹⁶ Bóna (1970) *Arch. Ért.* pp. 256–261.
- ¹¹⁷ Salamon-Erdélyi (1971) *Környe* pp. 44–45.
- ¹¹⁸ László (1965) *Études*
- ¹¹⁹ Op. cit. Pl. 44, 3–4.
- ¹²⁰ Op. cit. Pl. III 1–5.
- ¹²¹ Hampel (1905) *Altenthümer* vol. III. Pl. 263, 5–6.
- ¹²² Cf. Note 57.
- ¹²³ Cf. Note 57.
- ¹²⁴ Bóna (1979) *Arch. Ért.* p. 26.
- ¹²⁵ Cf. Note 21.
- ¹²⁶ Kovrig (1963) *Alattyán* p. 128.
- ¹²⁷ Török (1973) *FA* p. 123, Fig. 7, p. 125, Fig. 8. With respect of the belt-mounts of Kerepes grave E cf. Salamon (in this volume) *Makkoserdő* and Note.....
- ¹²⁸ Kovrig (1963) *Alattyán* pp. 125–126.
- ¹²⁹ Salamon (in this volume) *Makkoserdő*
- ¹³⁰ Kovrig (1963) *Alattyán* pp. 133–134.
- ¹³¹ Cf. Note 53.
- ¹³² Werner (1955) *Kölner Jb.* p. 40, Abb. 5 and Karte 2 Liste 4. Type Bologna No. 8 Szeged-Kundomb; Vinski (1968) *Vjesnik* Taf. 9, 51.
- ¹³³ Cf. Note 53.
- ¹³⁴ Garam (1975) *Szebény* Figs. 19, 20, 21, 23 — Graves 245, 290, 3,4, 335.
- ¹³⁵ Horváth (1936) *Üllő és Kiskőrös* p. 48, Fig. 10, Pl. 32, 33.
- ¹³⁶ Op. cit. p. 110, Abb. 31.
- ¹³⁷ Similar to mounts with palmette decorations: Kecel, Határdúló grave 74. Cs. Sós (1958) *Kecel* Pl. 12.

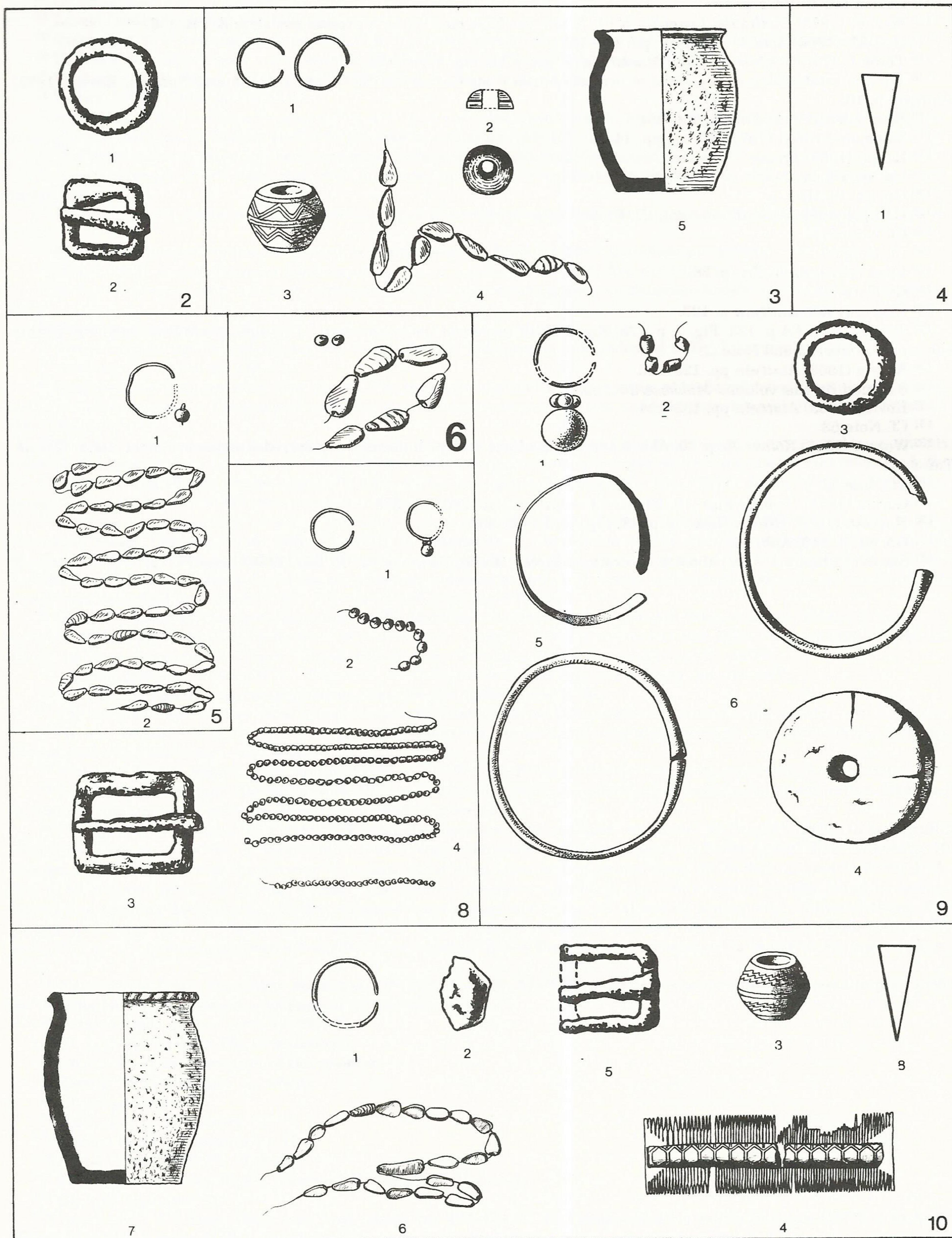

Plate 1 Szeged-Kundomb Graves 2-6, 8-10

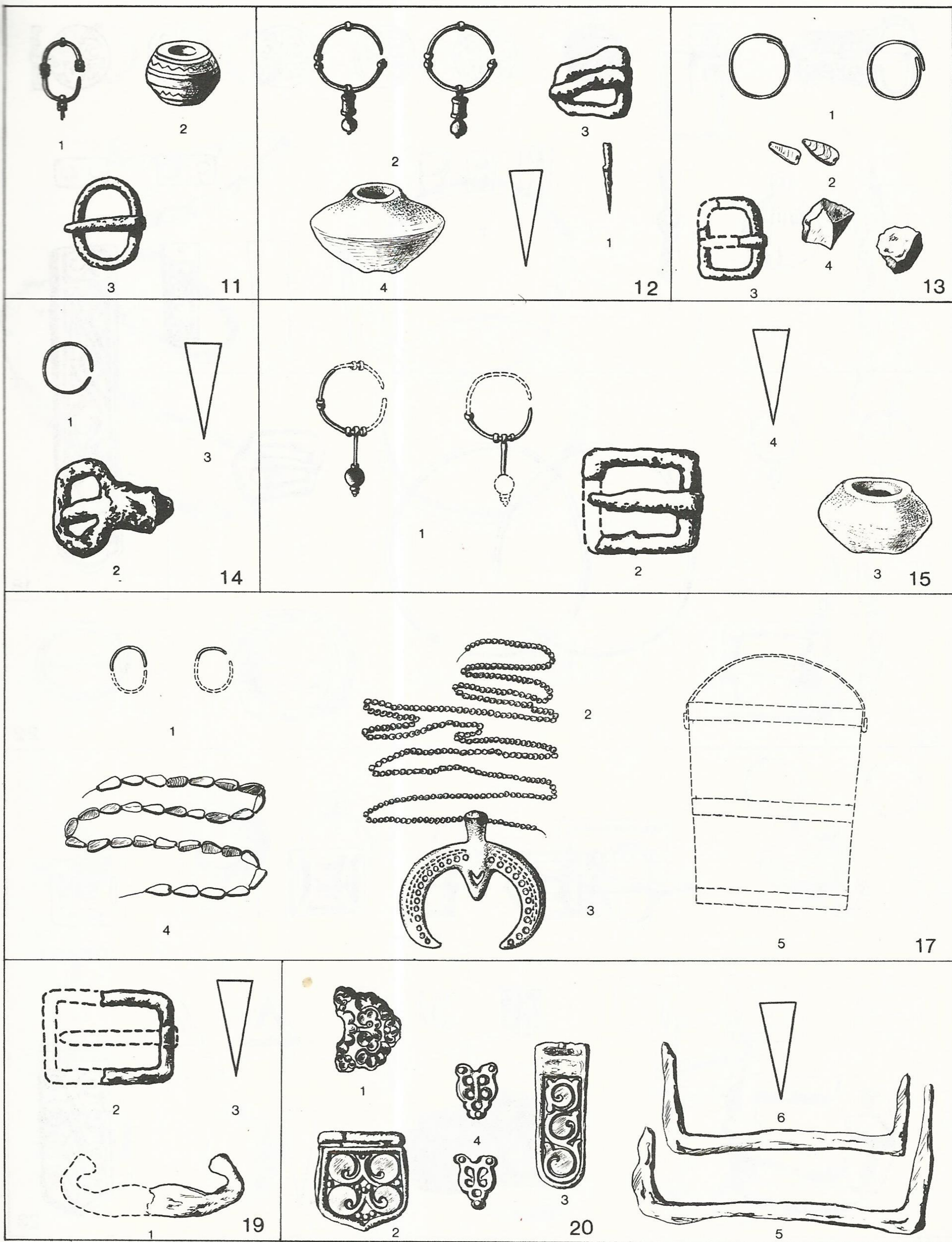

Plate 2 Szeged-Kundomb Graves 11-15, 17, 19-20

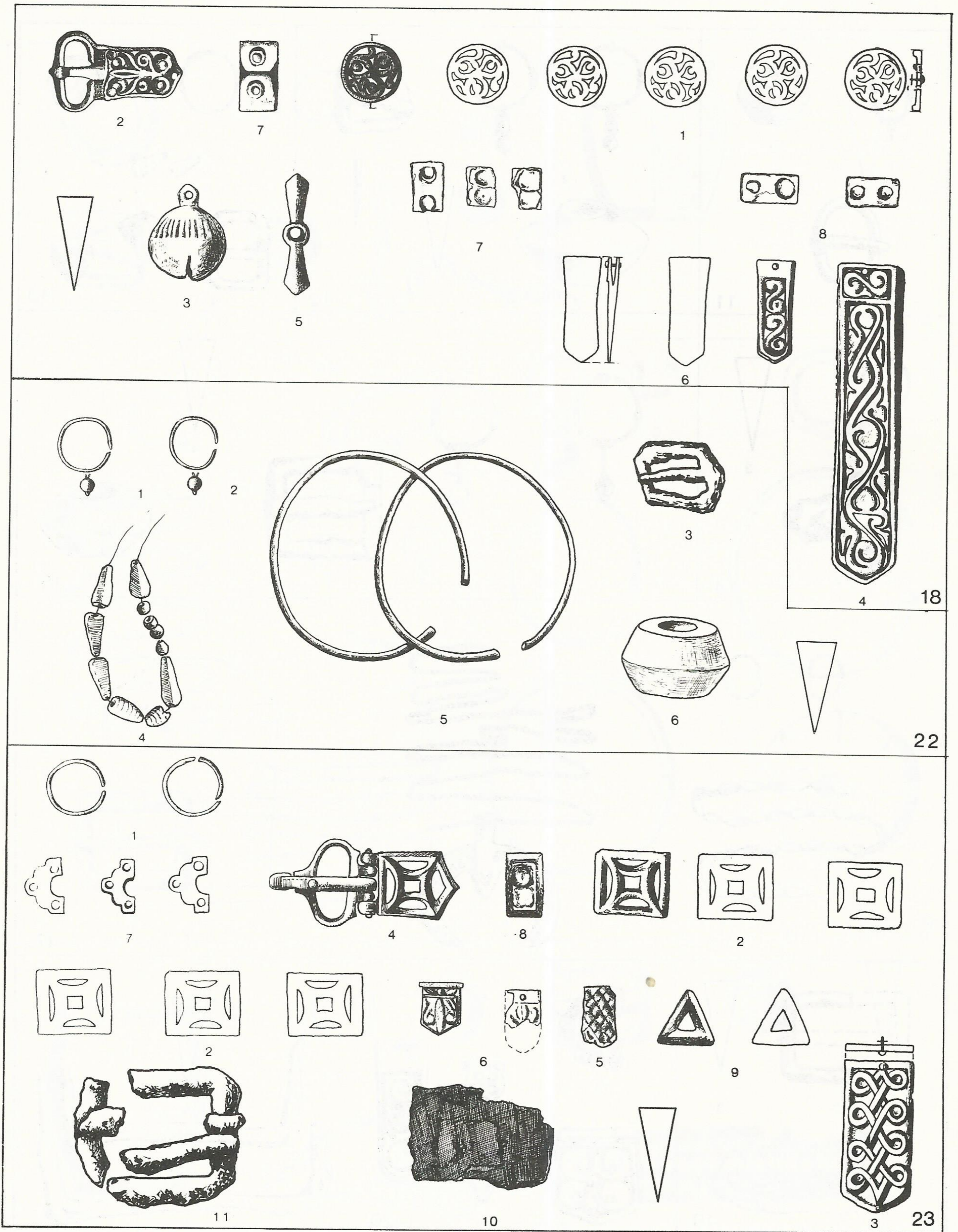

Plate 3 Szeged-Kundomb Graves 18, 22, 23

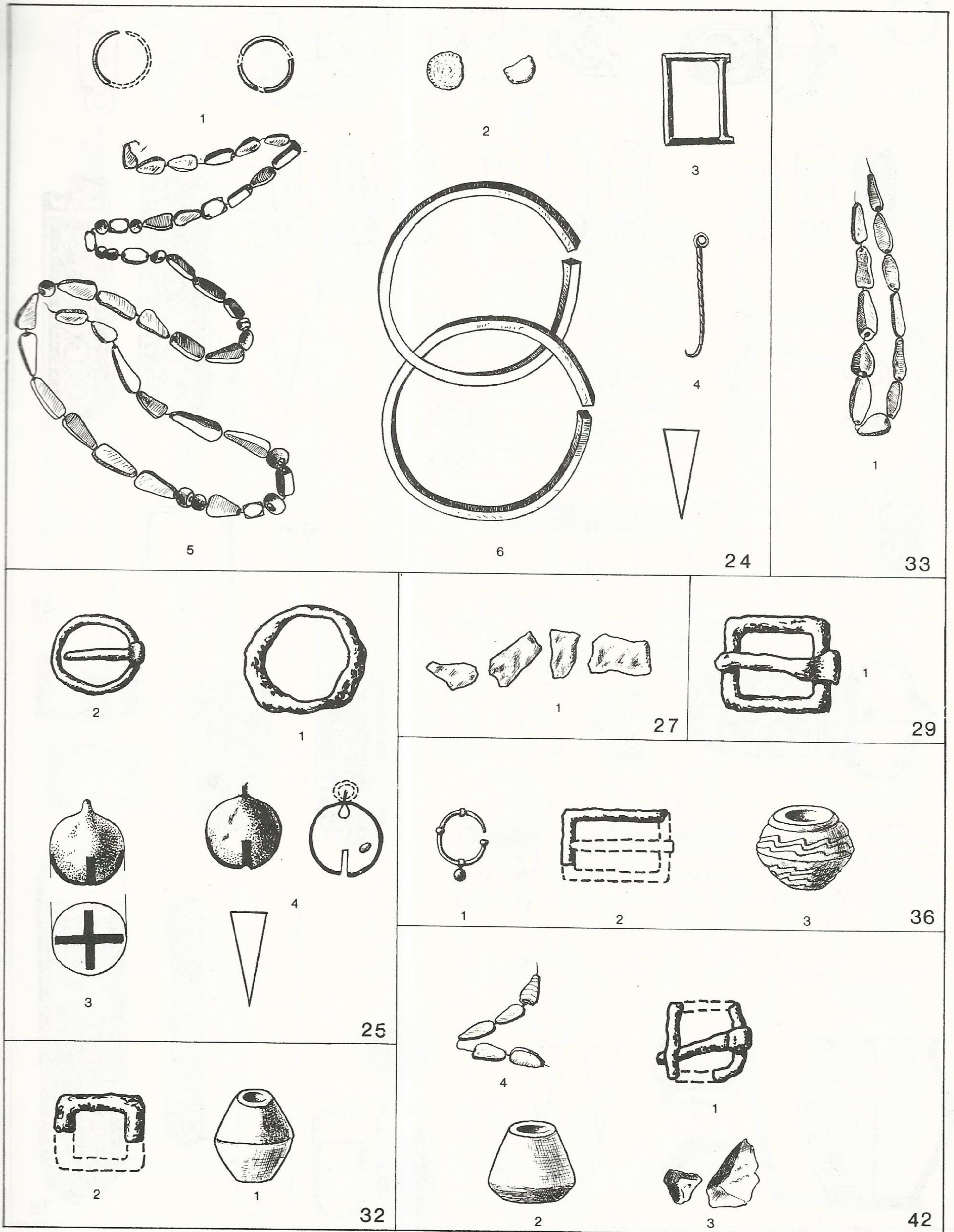

Plate 4 Szeged-Kundomb Graves 24, 25, 27, 29, 32, 33, 42

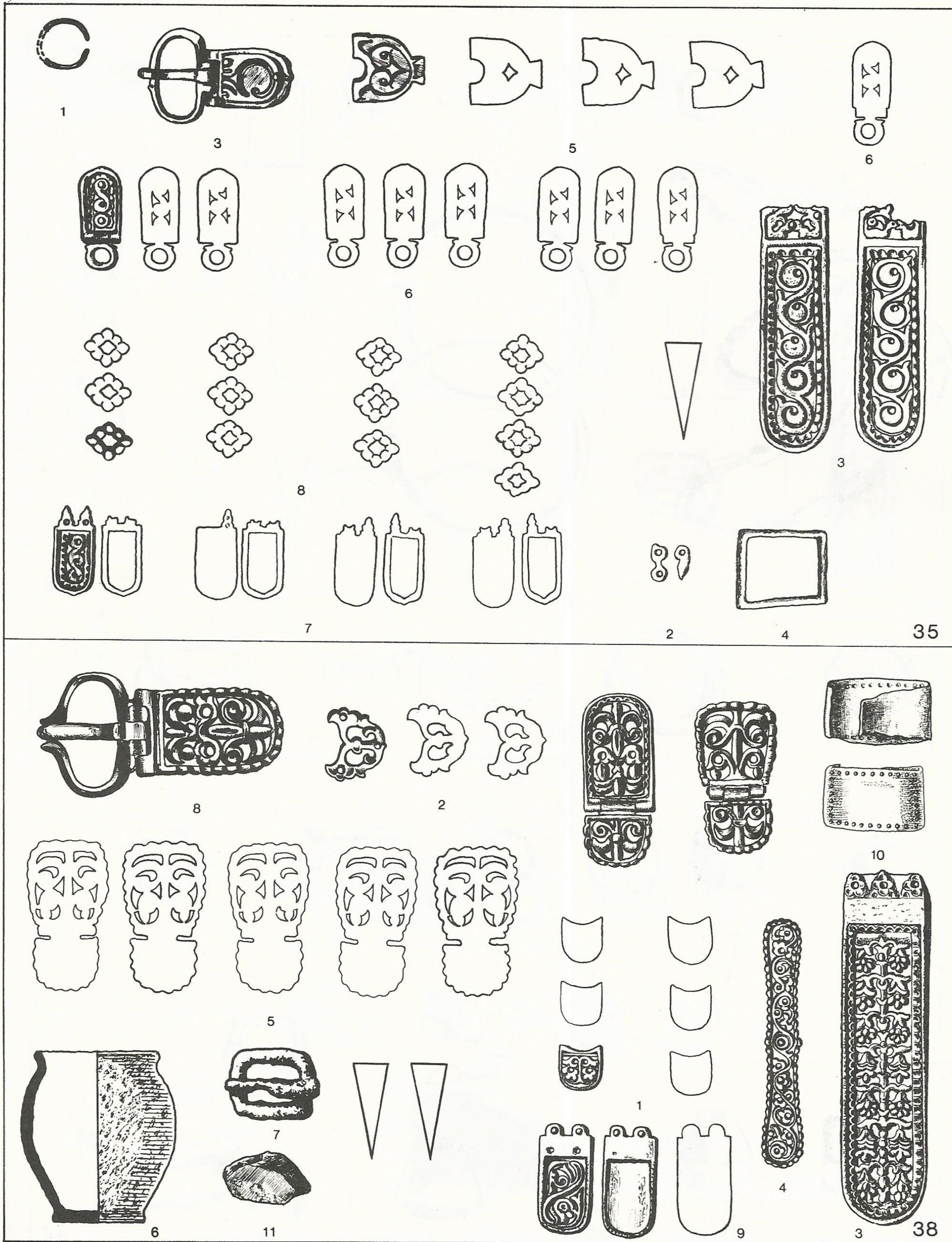

Plate 5 Szeged-Kundomb Graves 35, 38

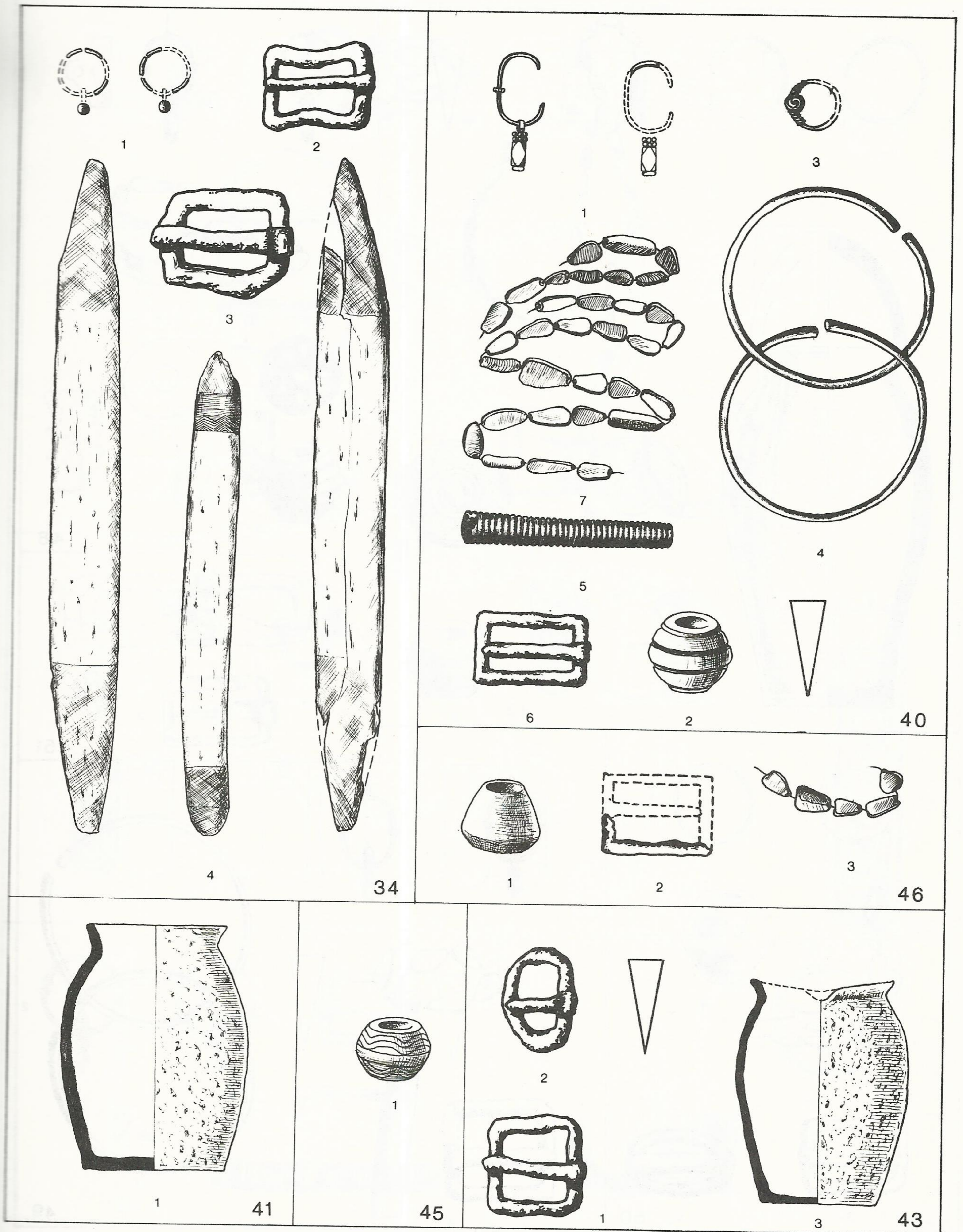

Plate 6 Szeged-Kundomb Graves 34, 40, 4, 43, 45, 46

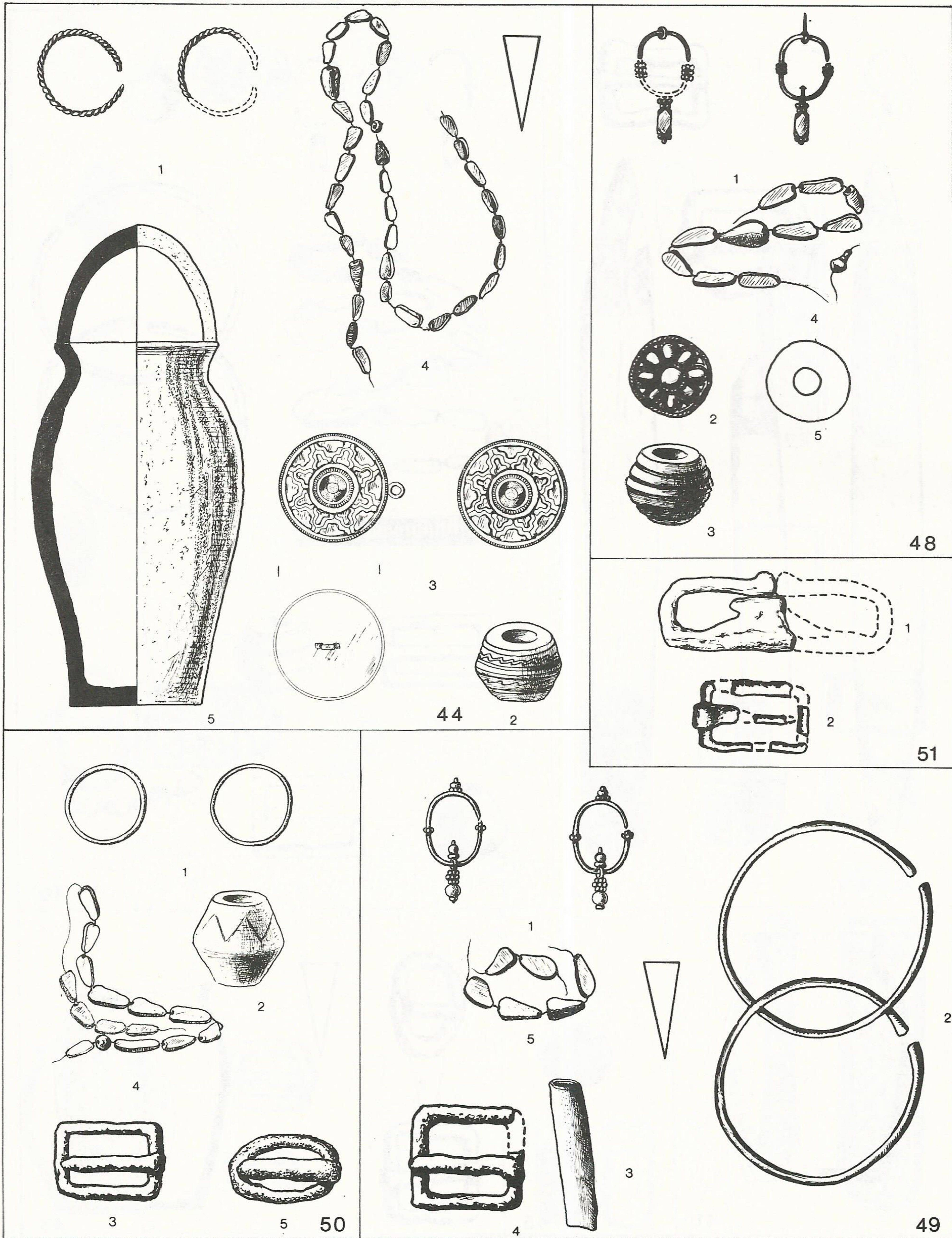
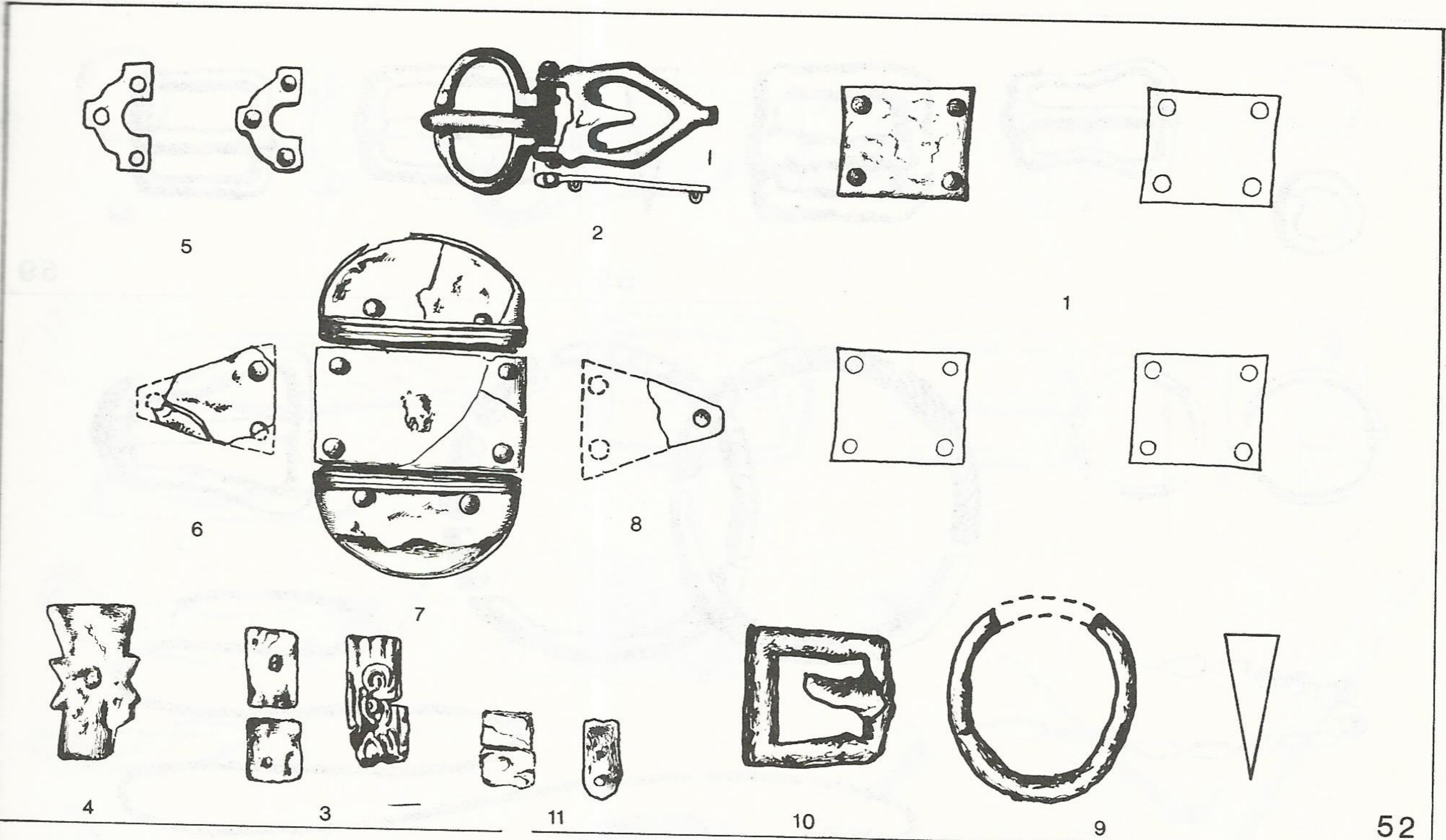
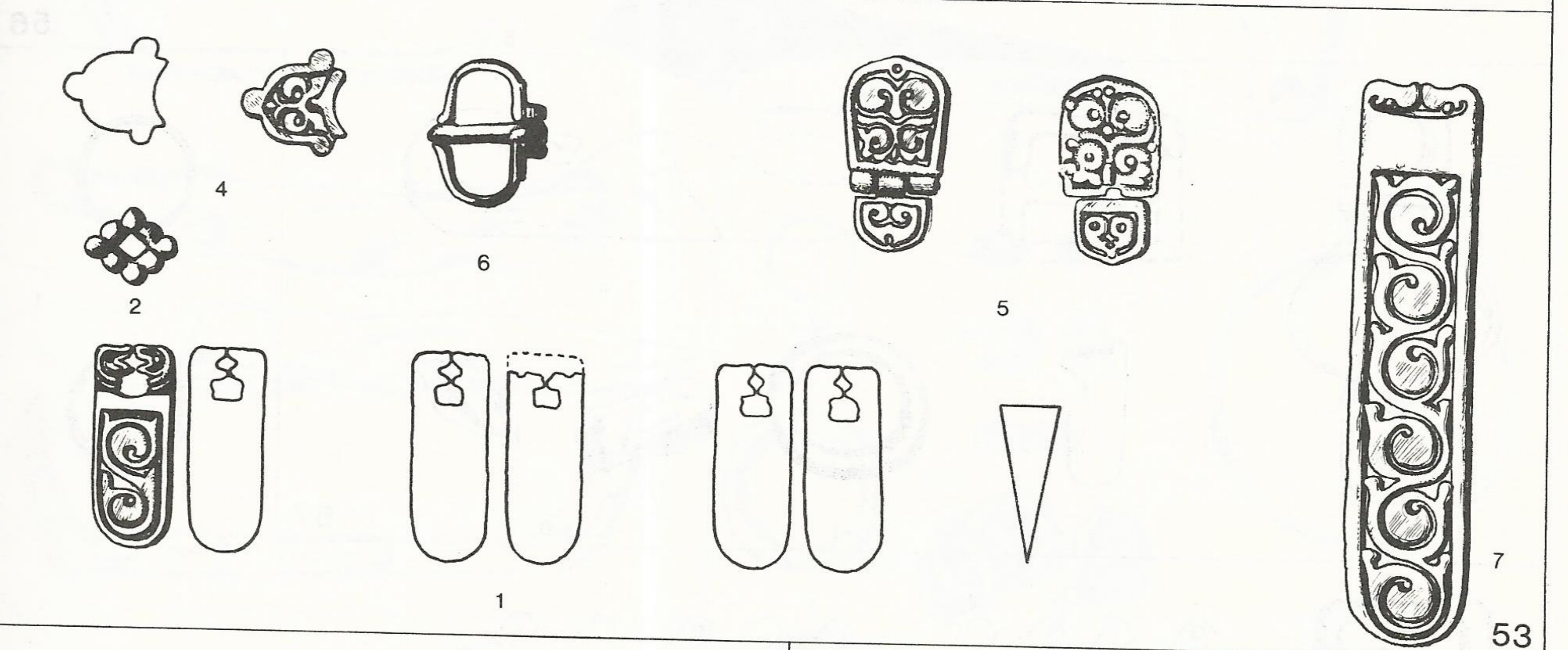

Plate 7 Szeged-Kundomb Graves 44, 48-51



52



53

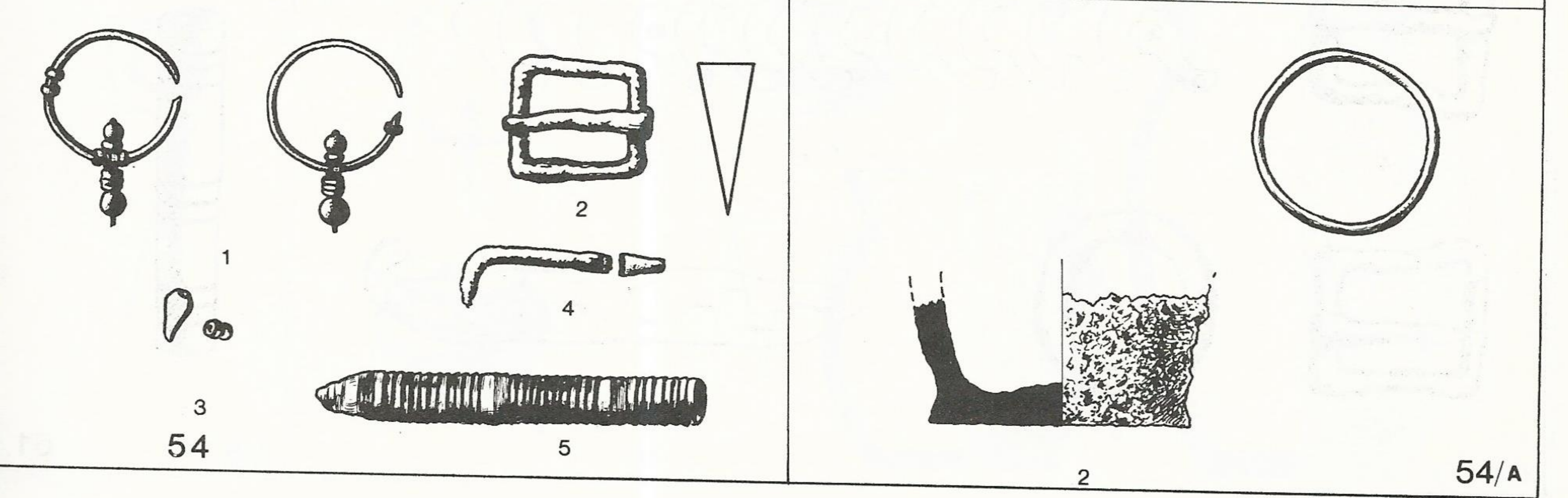

54

54/A

Plate 8 Szeged-Kundomb Graves 52-54a

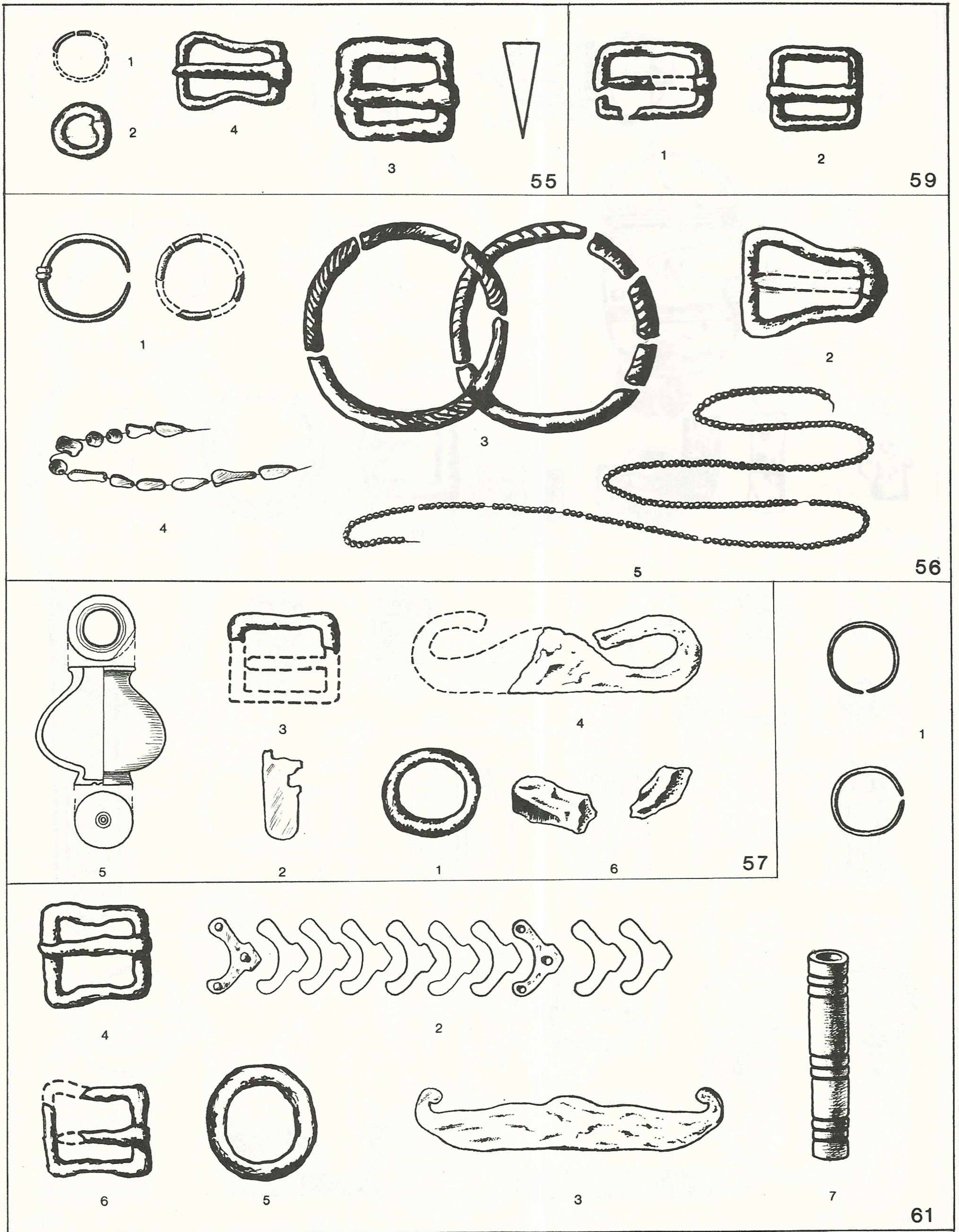

Plate 9 Szeged-Kundomb Graves 55-57, 59, 61

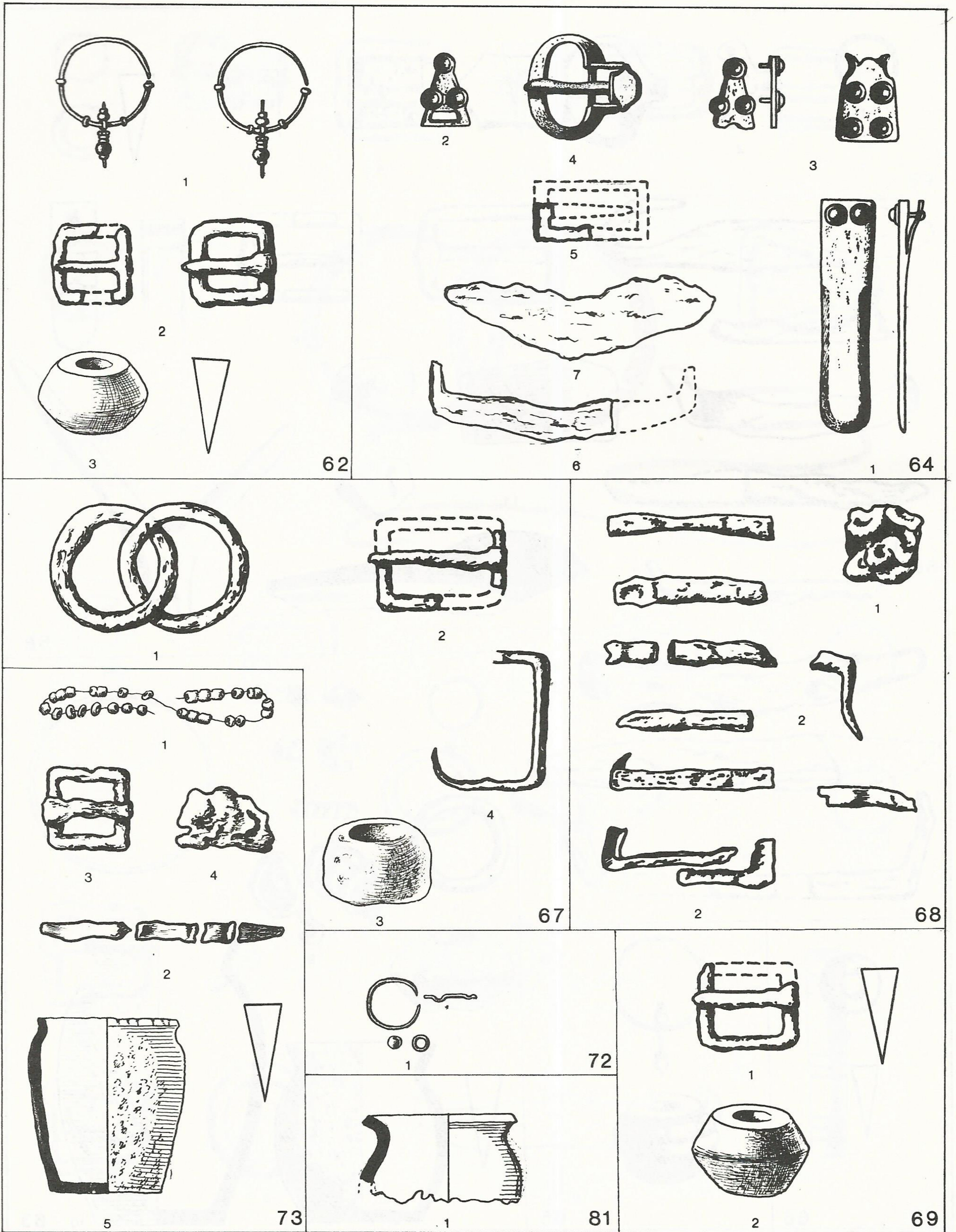

Plate 11 Szeged-Kundomb Graves 62, 64, 67-69, 72, 73, 81

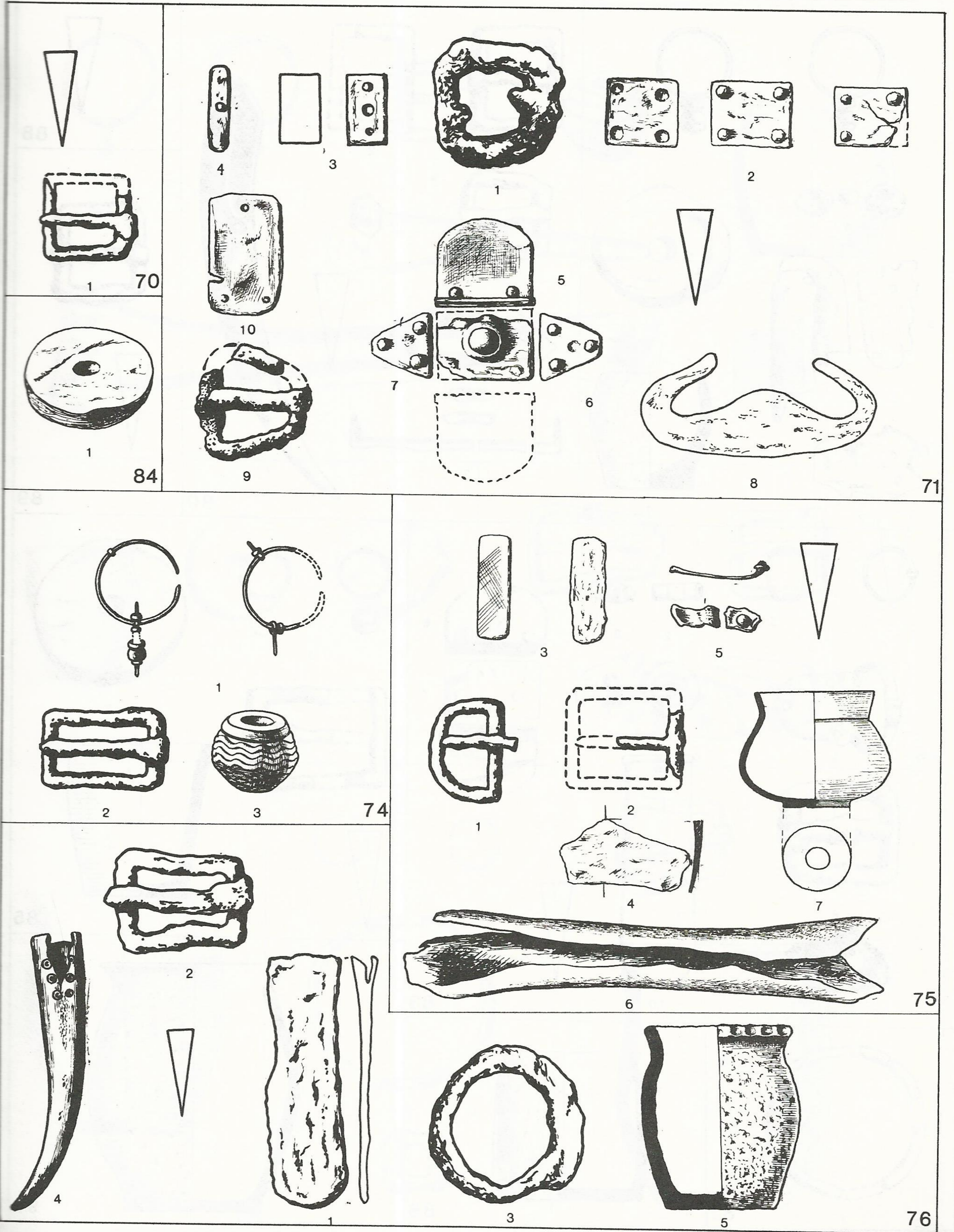

Plate 12 Szeged-Kundomb Graves 70, 71, 74-76, 84

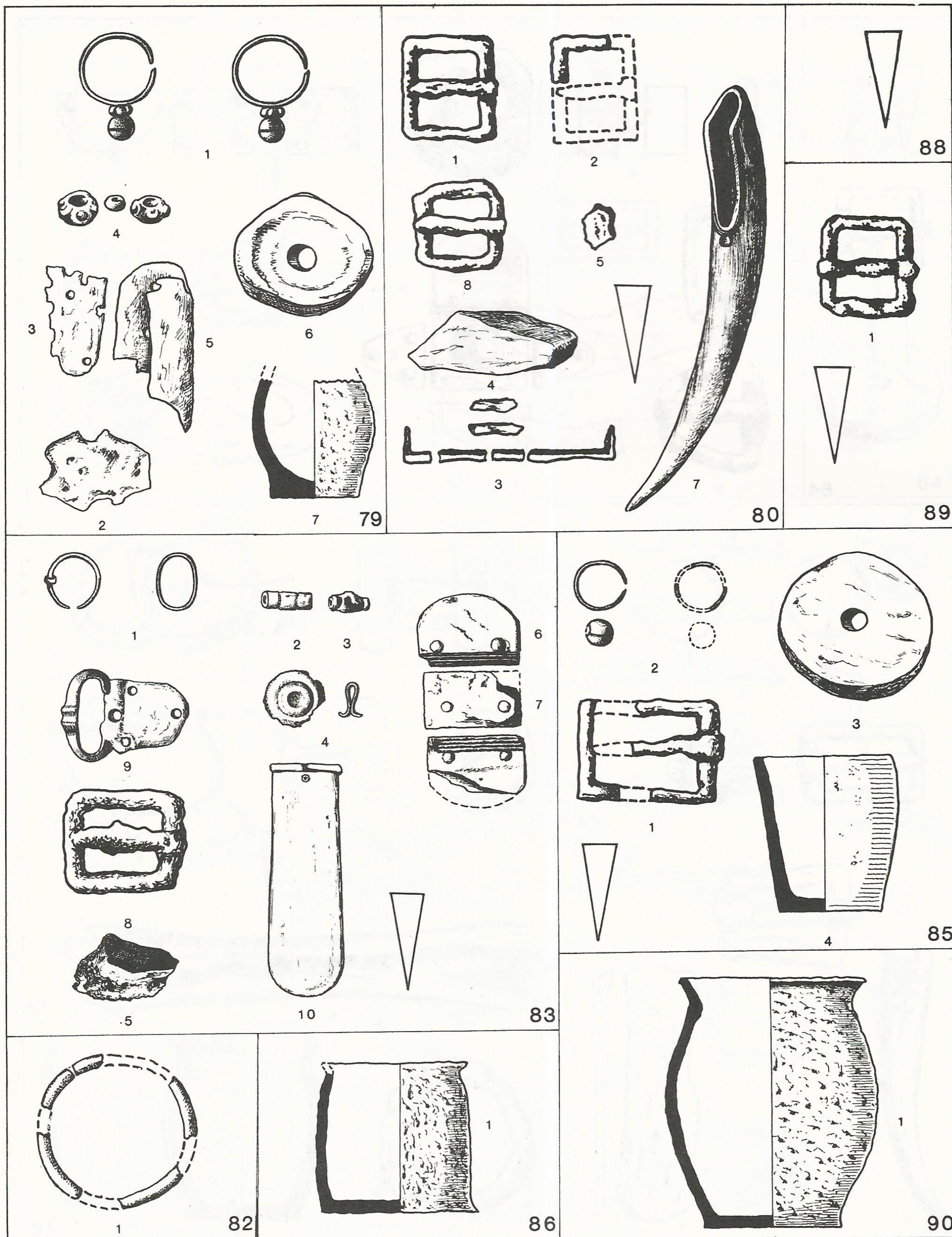
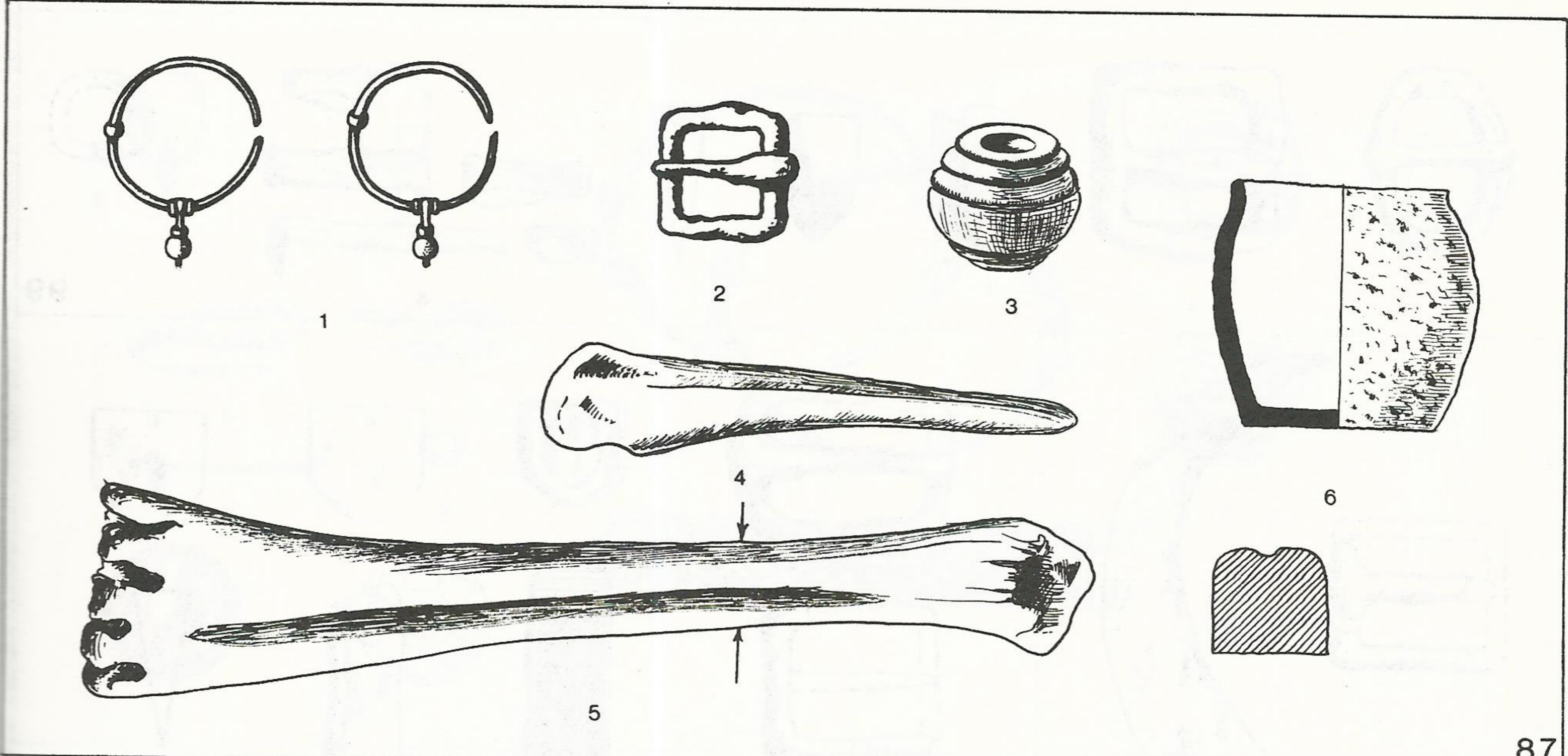
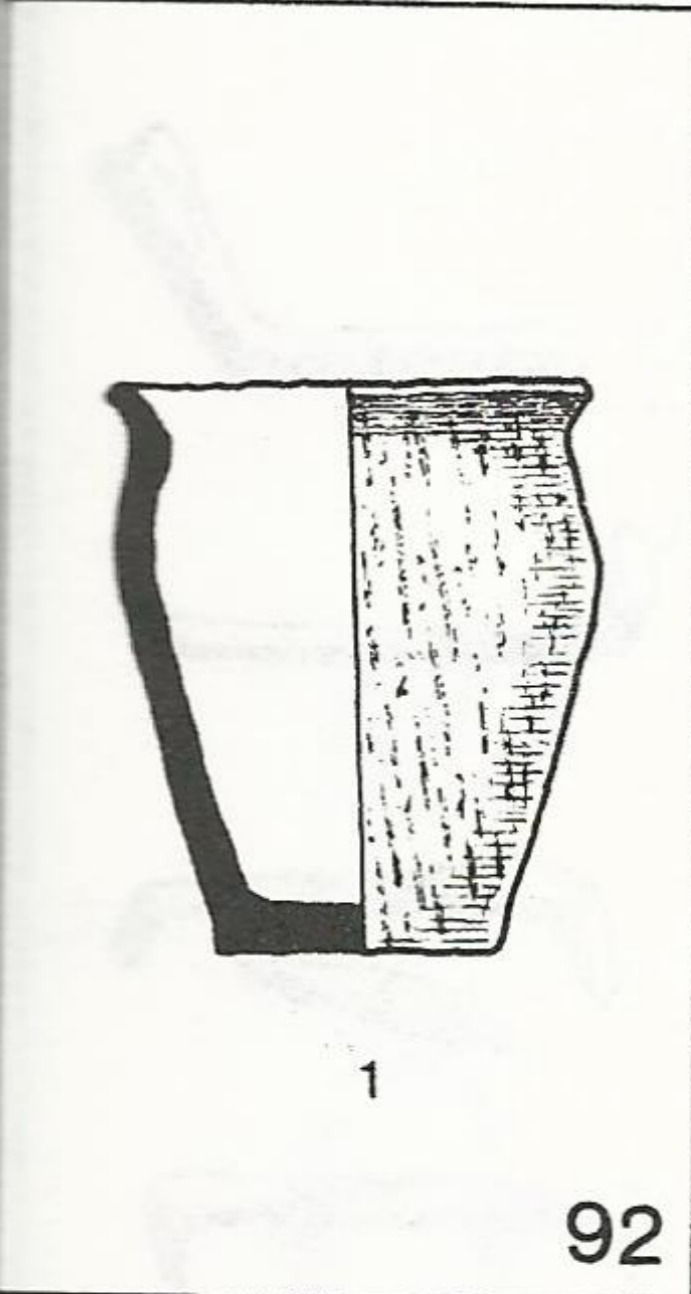

Plate 13 Szeged-Kundomb Graves 79, 80, 82, 83, 85, 86, 88, 89, 90



87



92

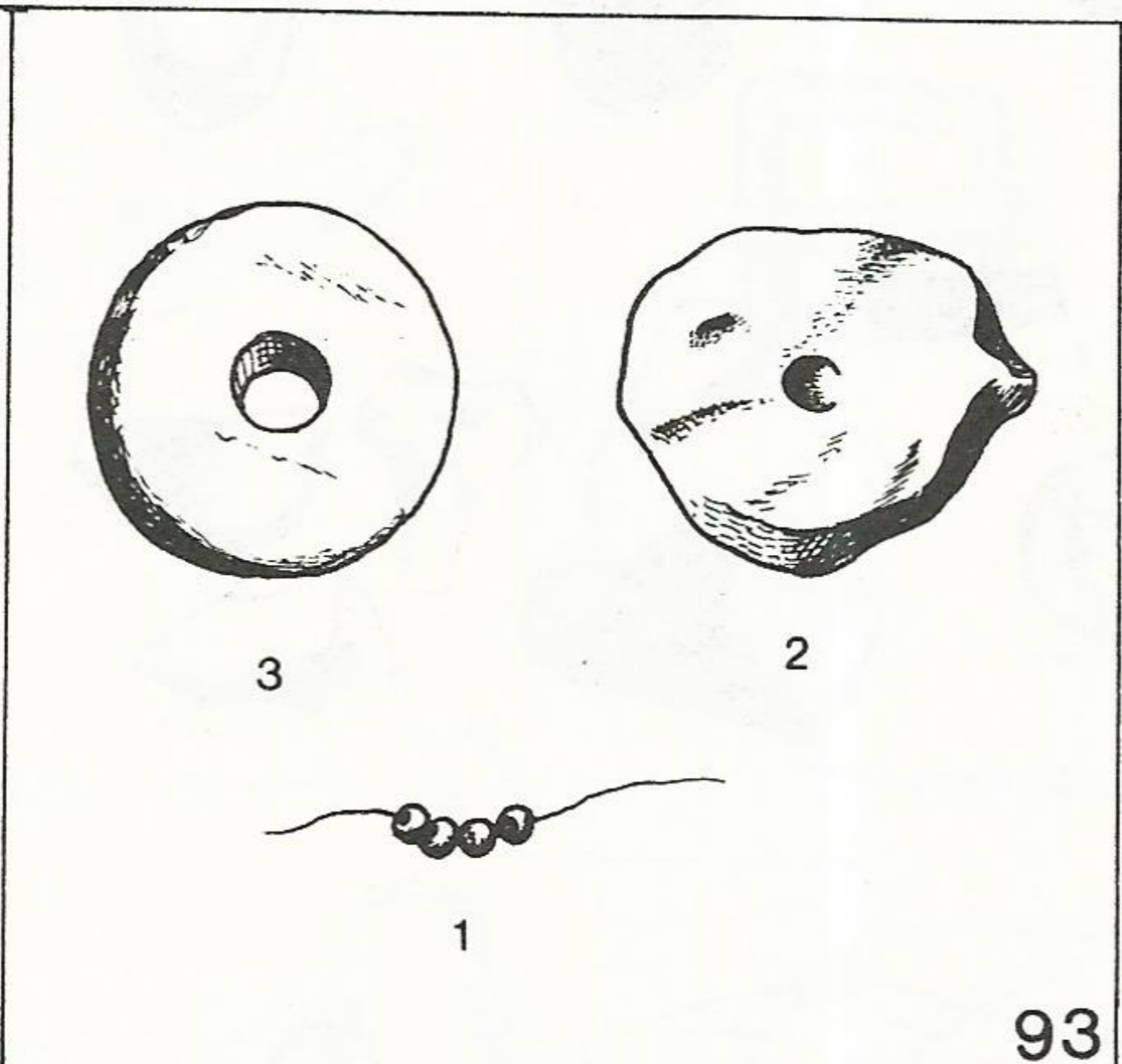

93

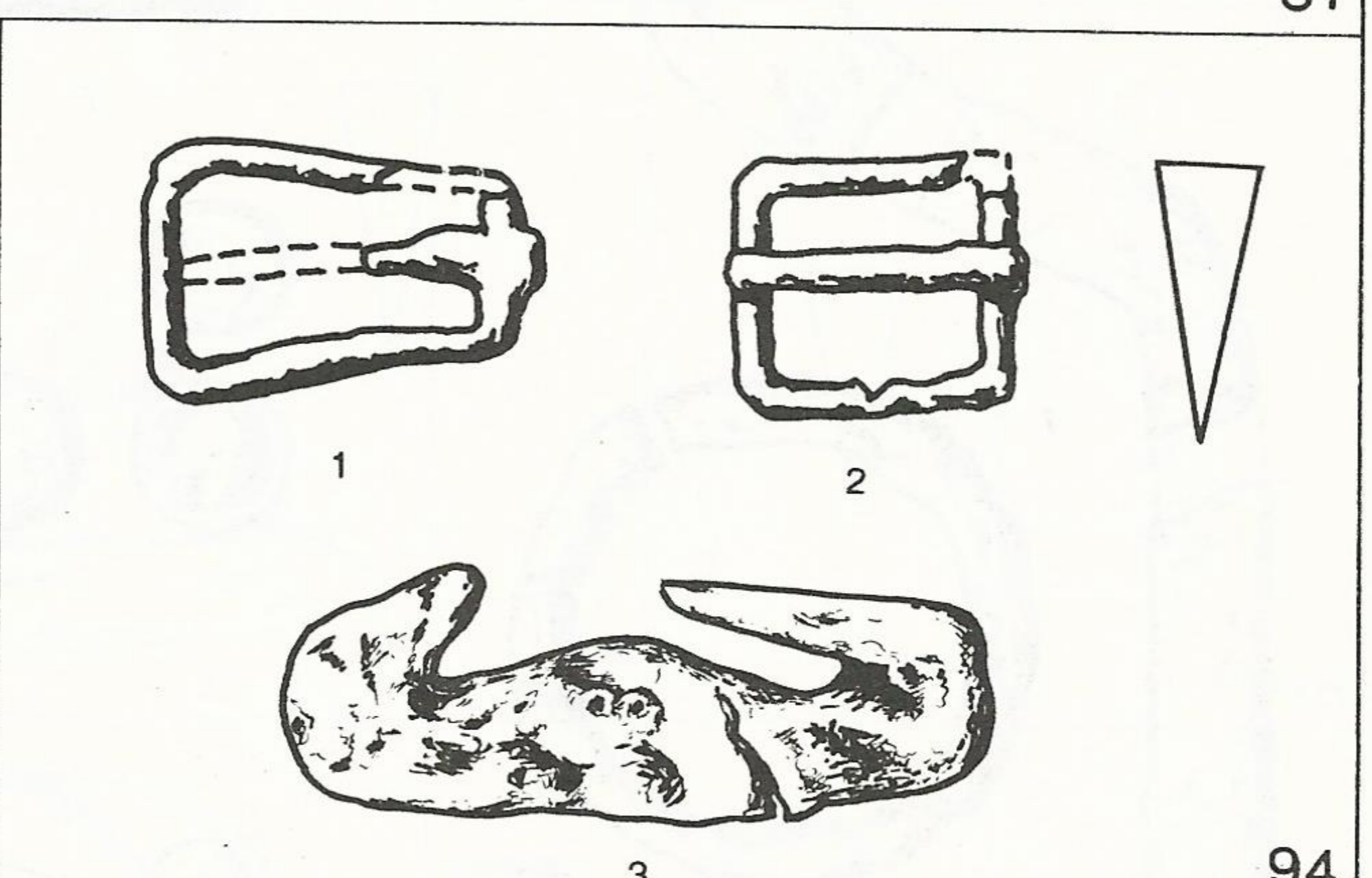

94

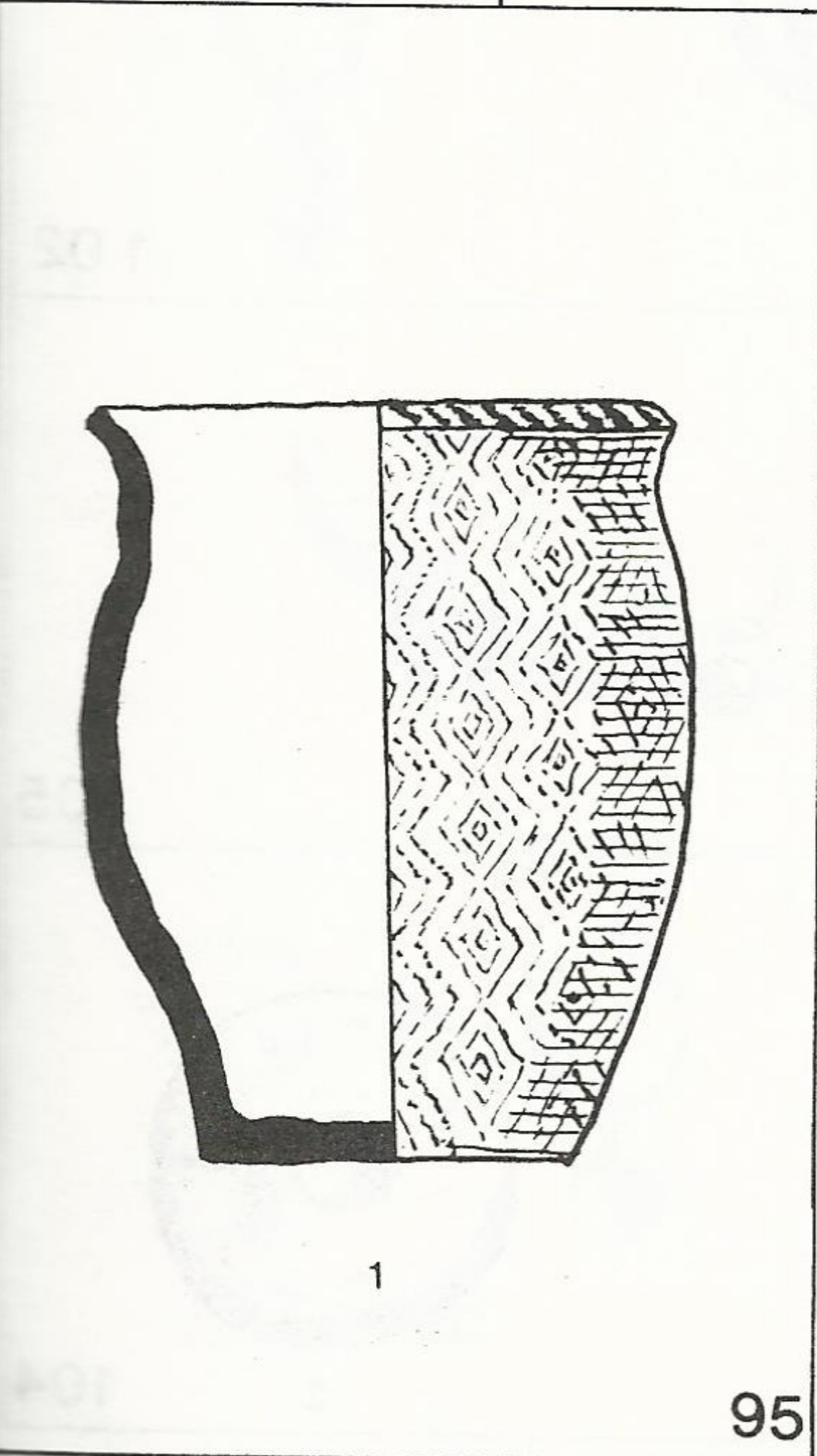

95

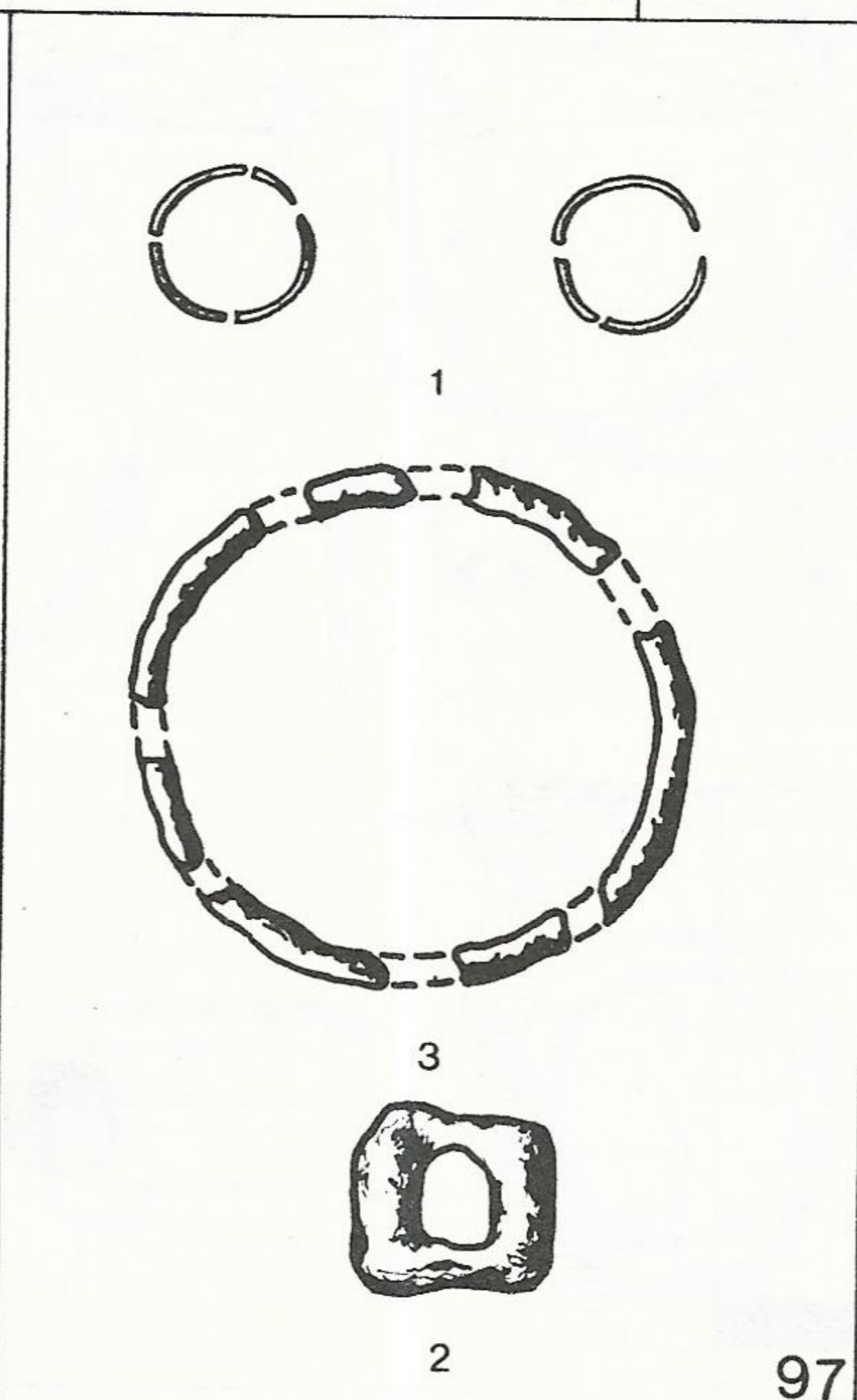

97

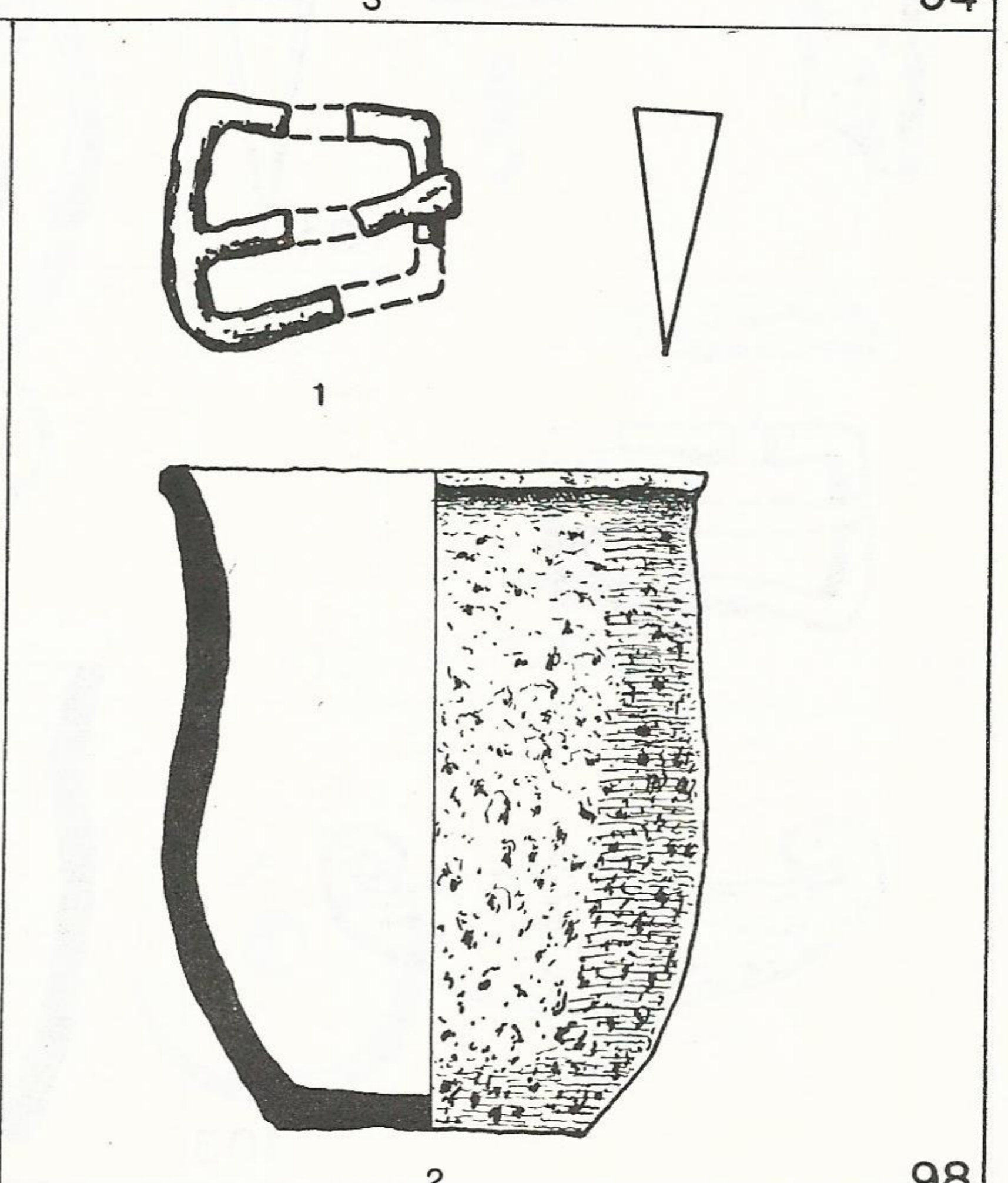

98

Plate 14 Szeged-Kundomb Graves 87, 92-95, 97, 98

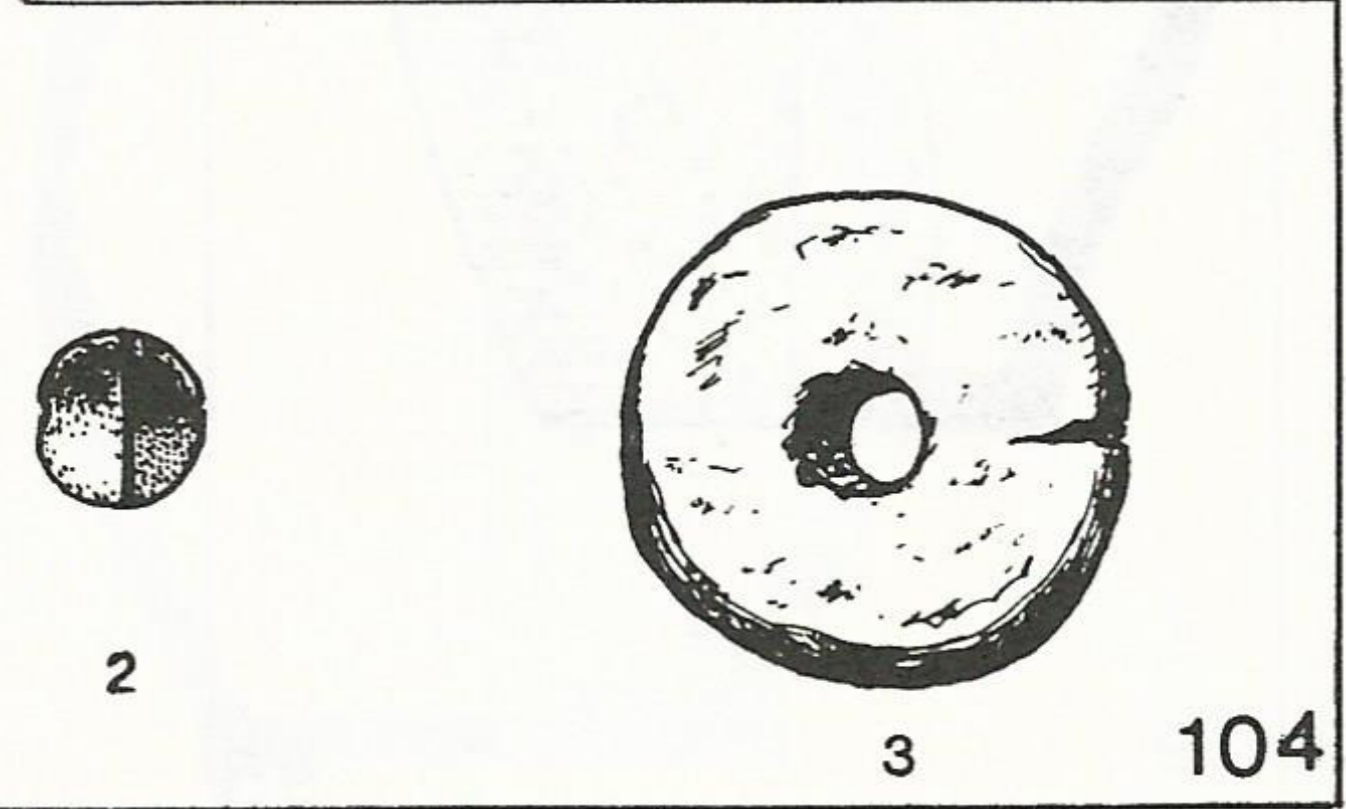
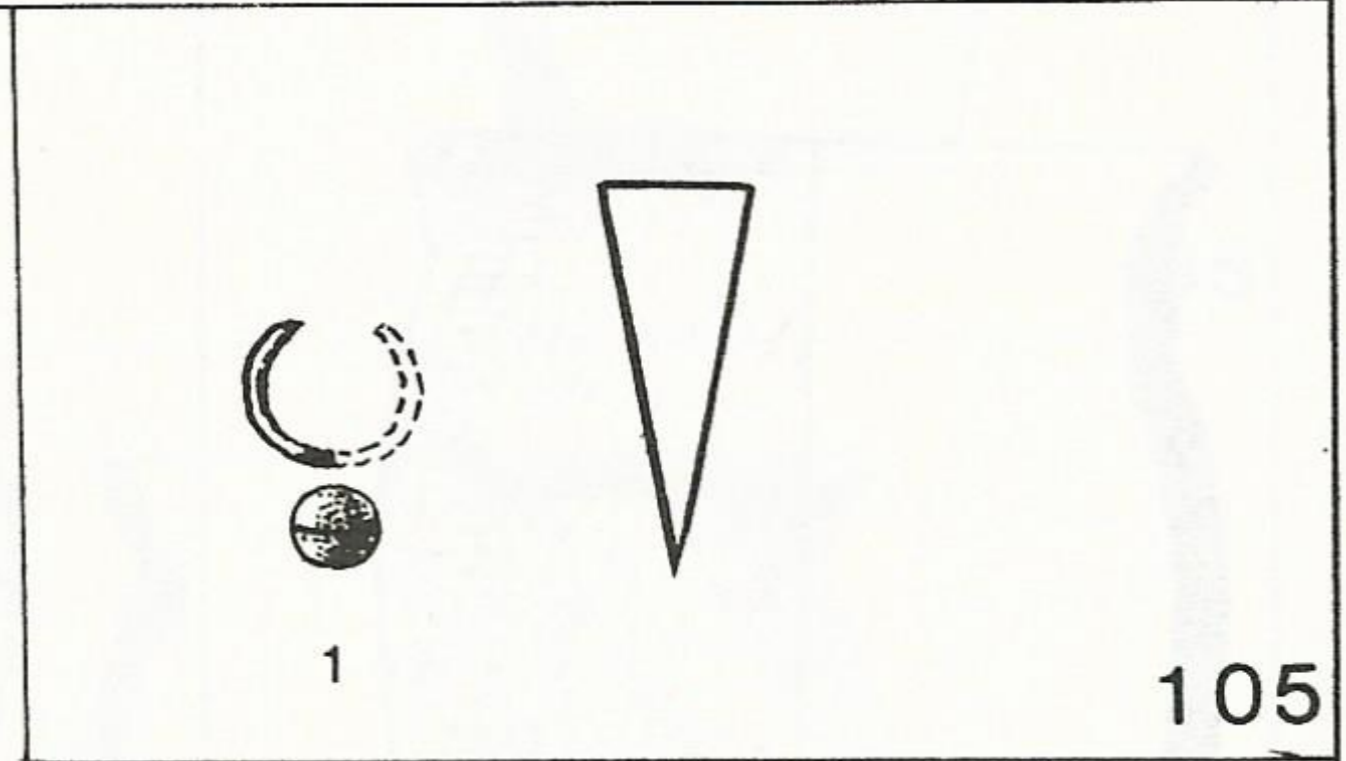
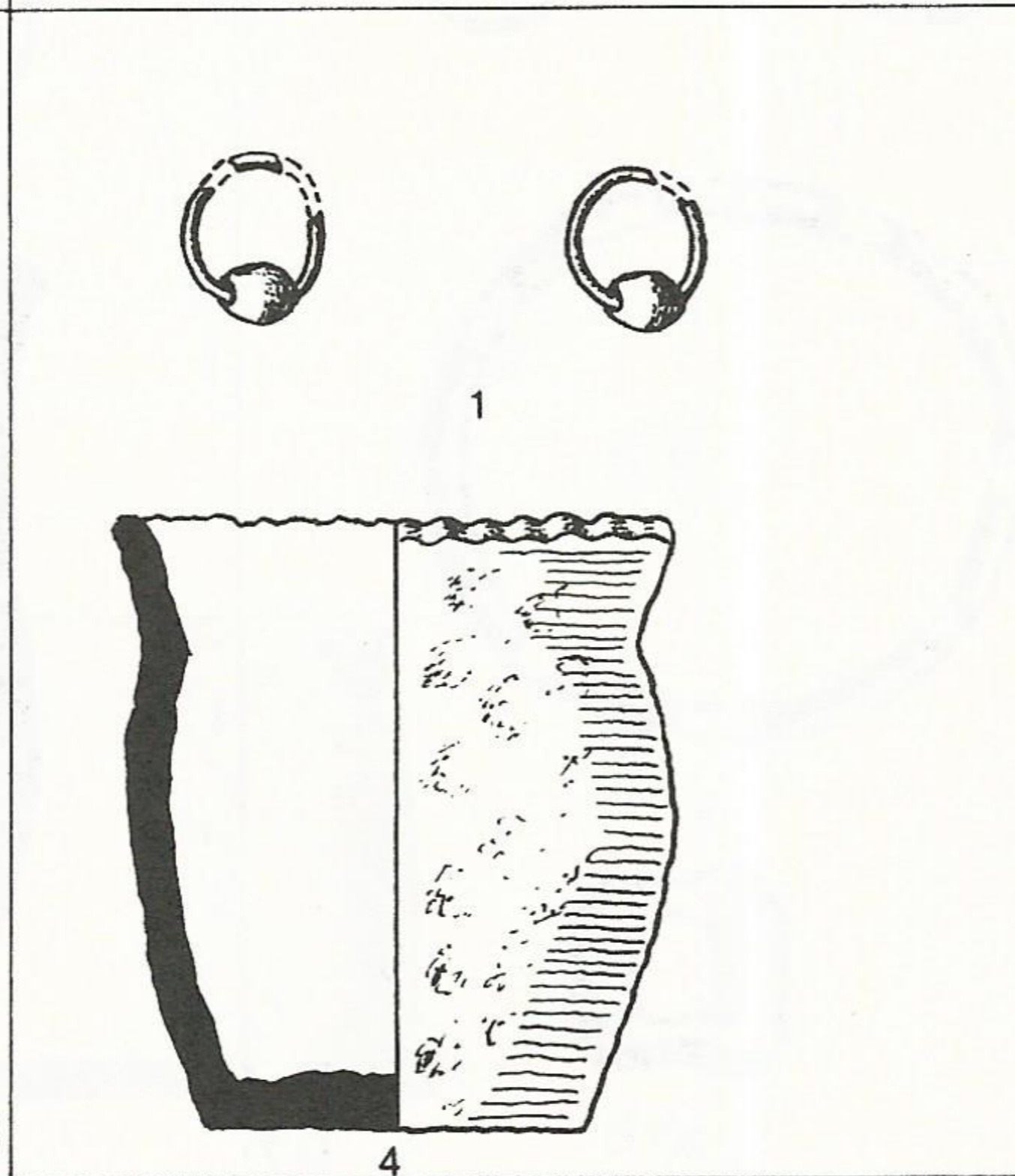
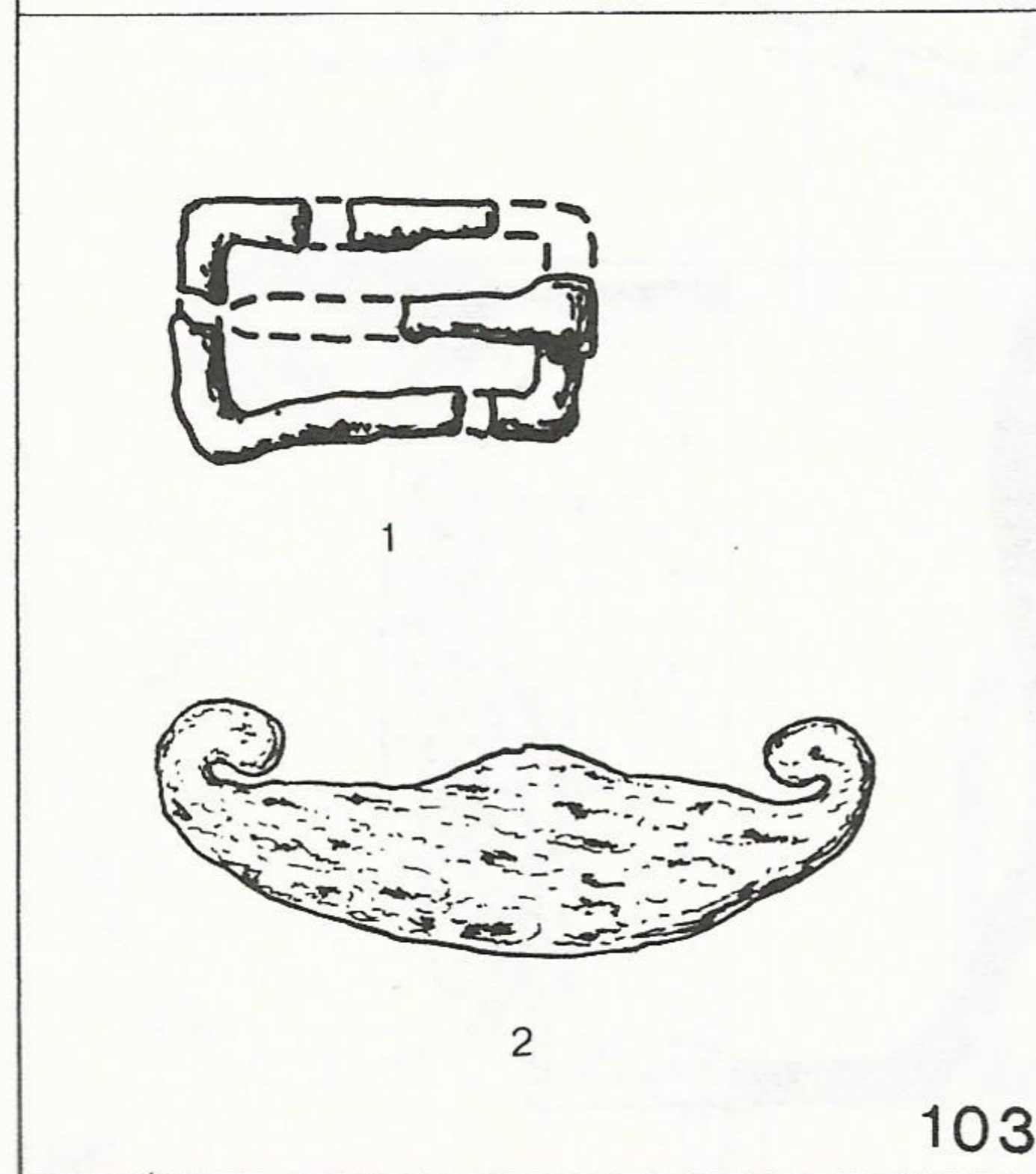
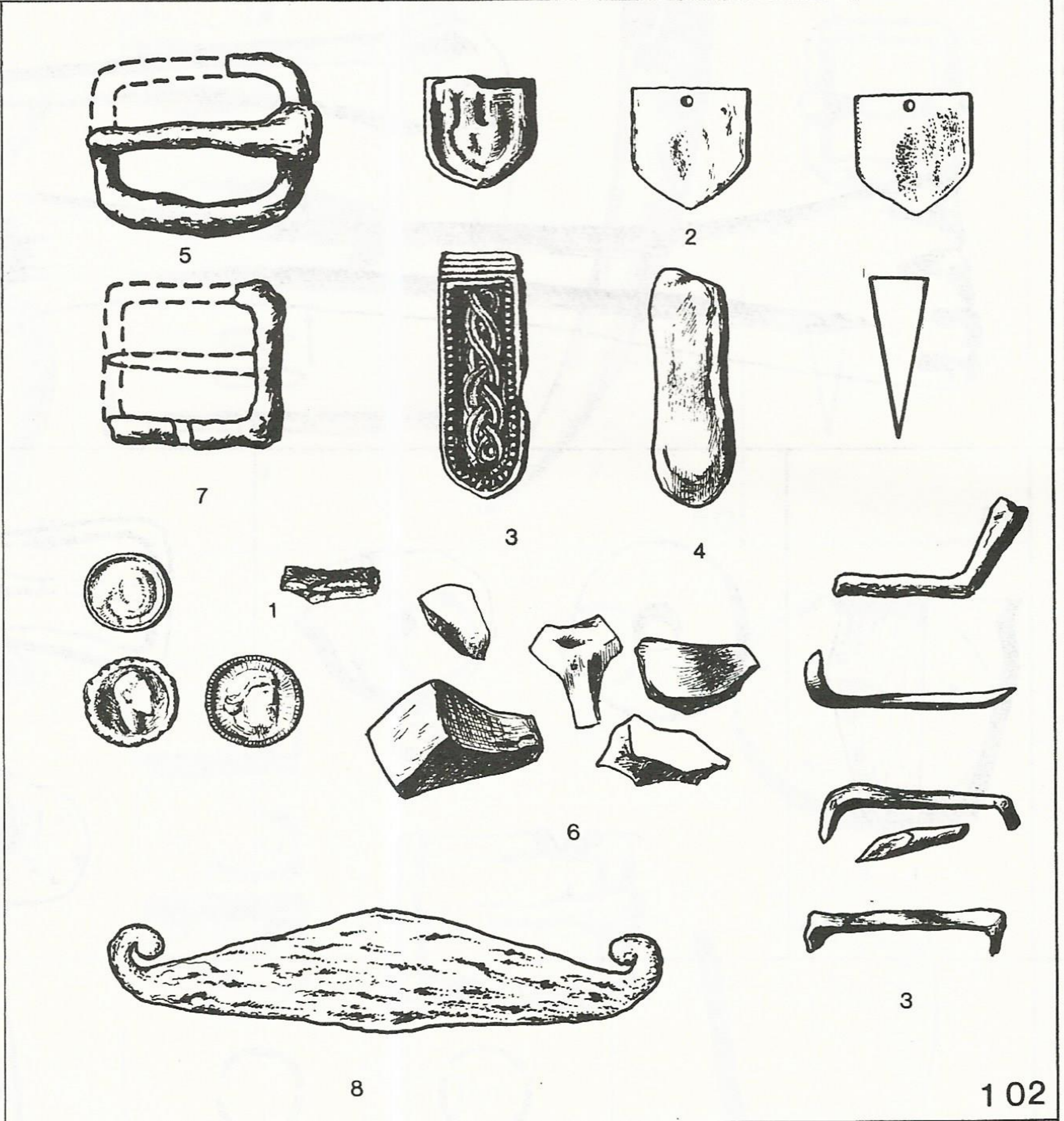
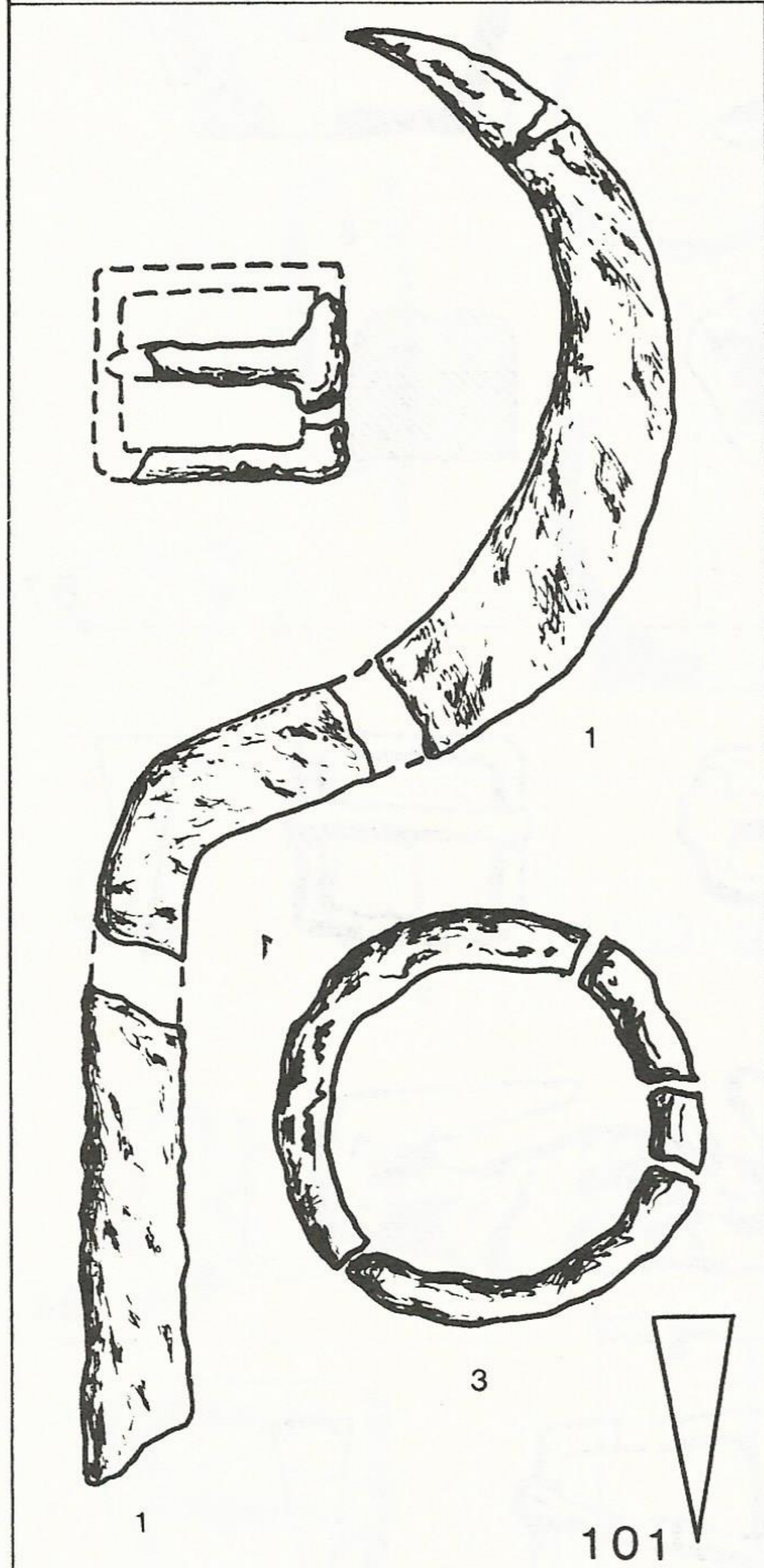
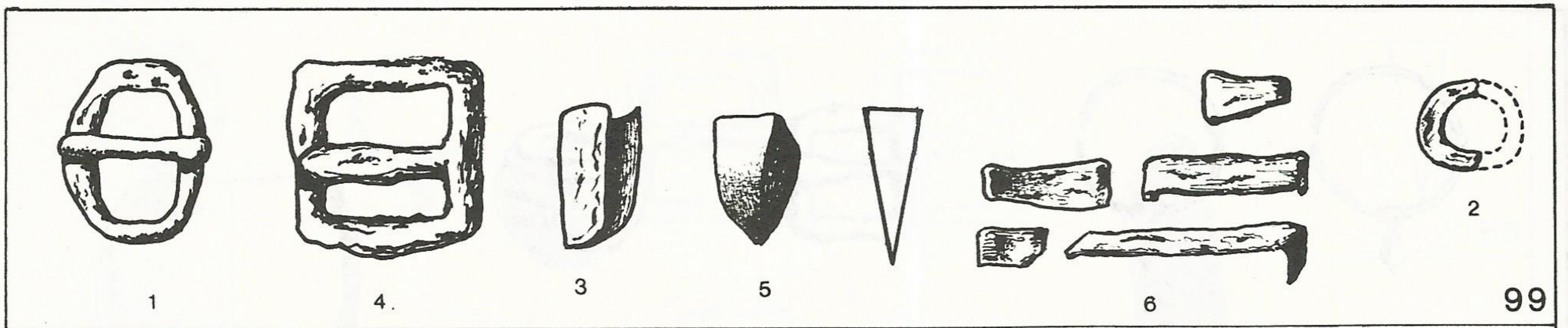

Plate 15 Szeged-Kundomb Graves 99, 101-105

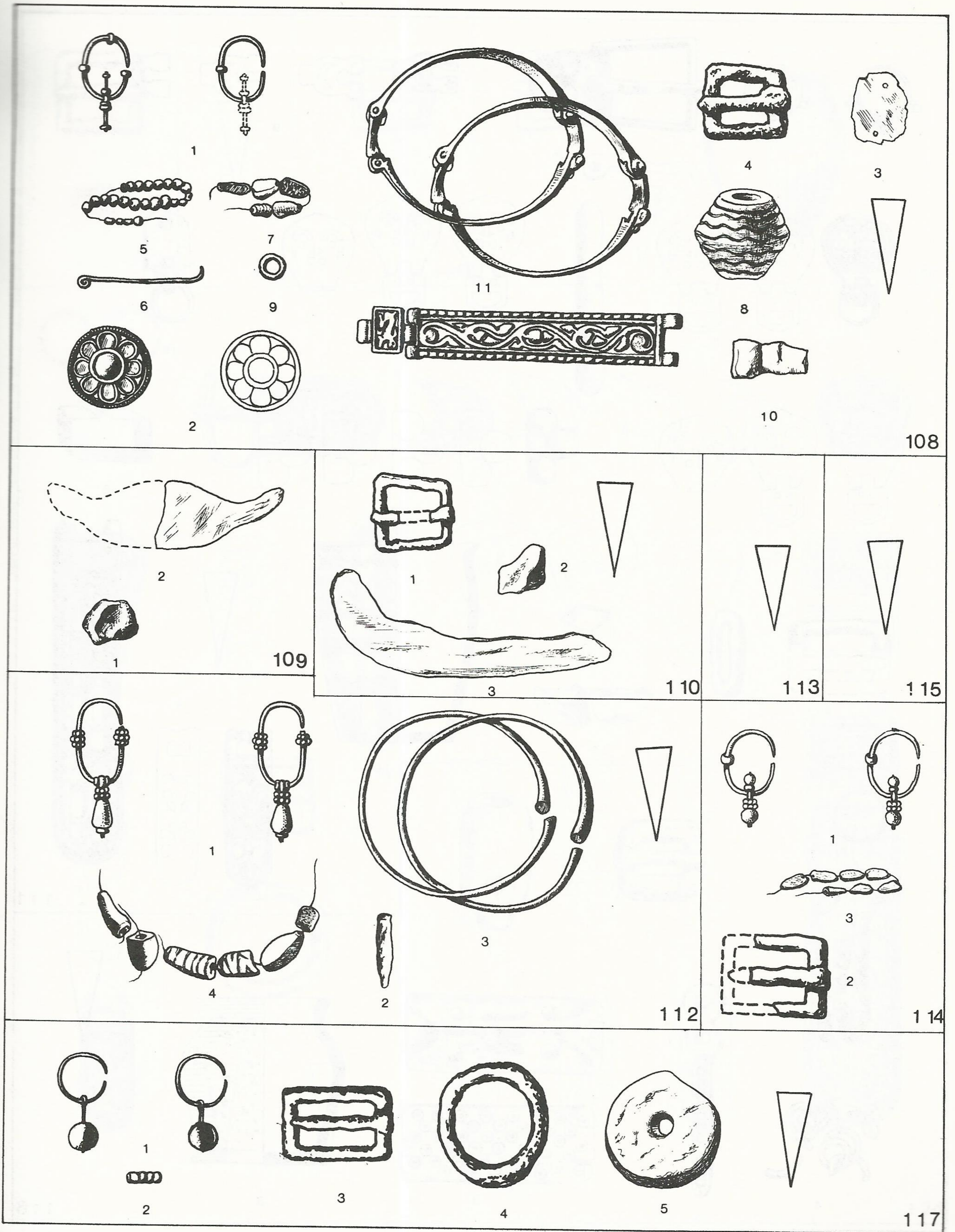

Plate 16 Szeged-Kundomb Graves 108-110, 112-115, 117

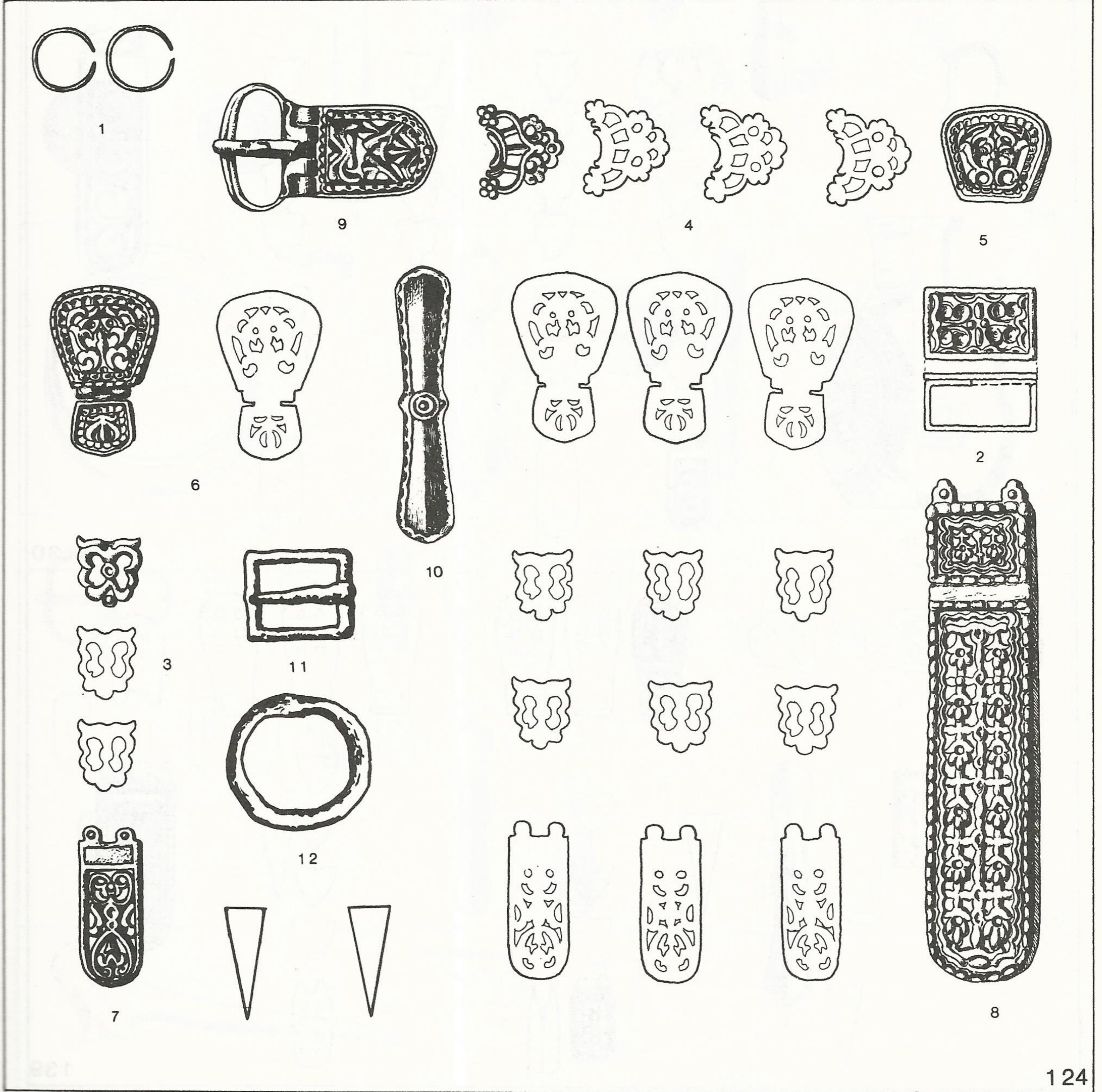
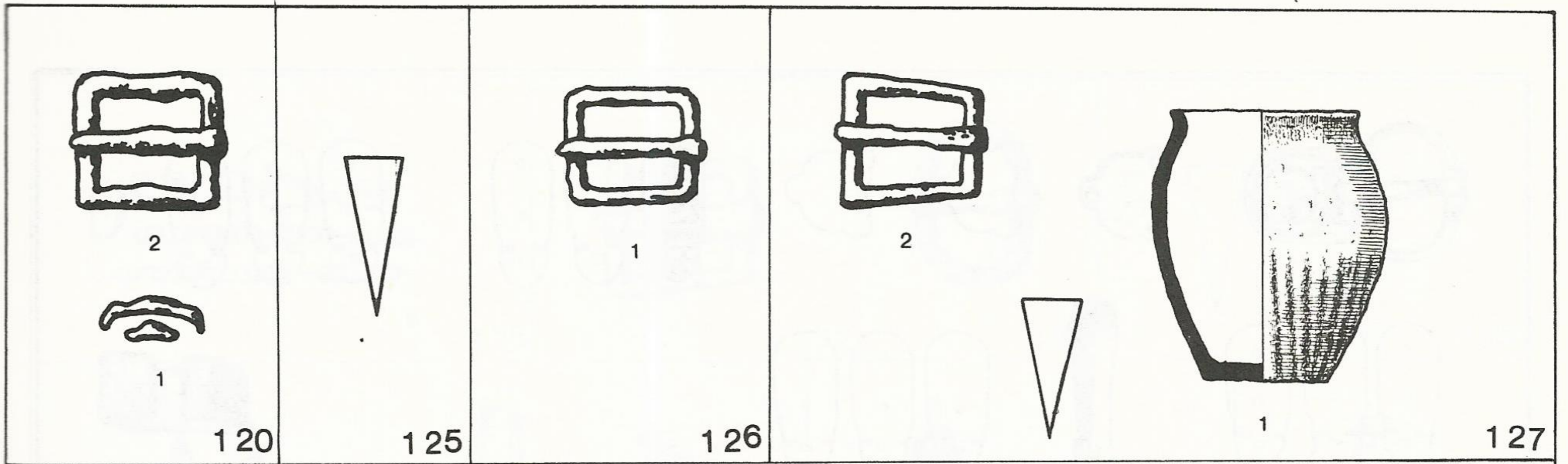
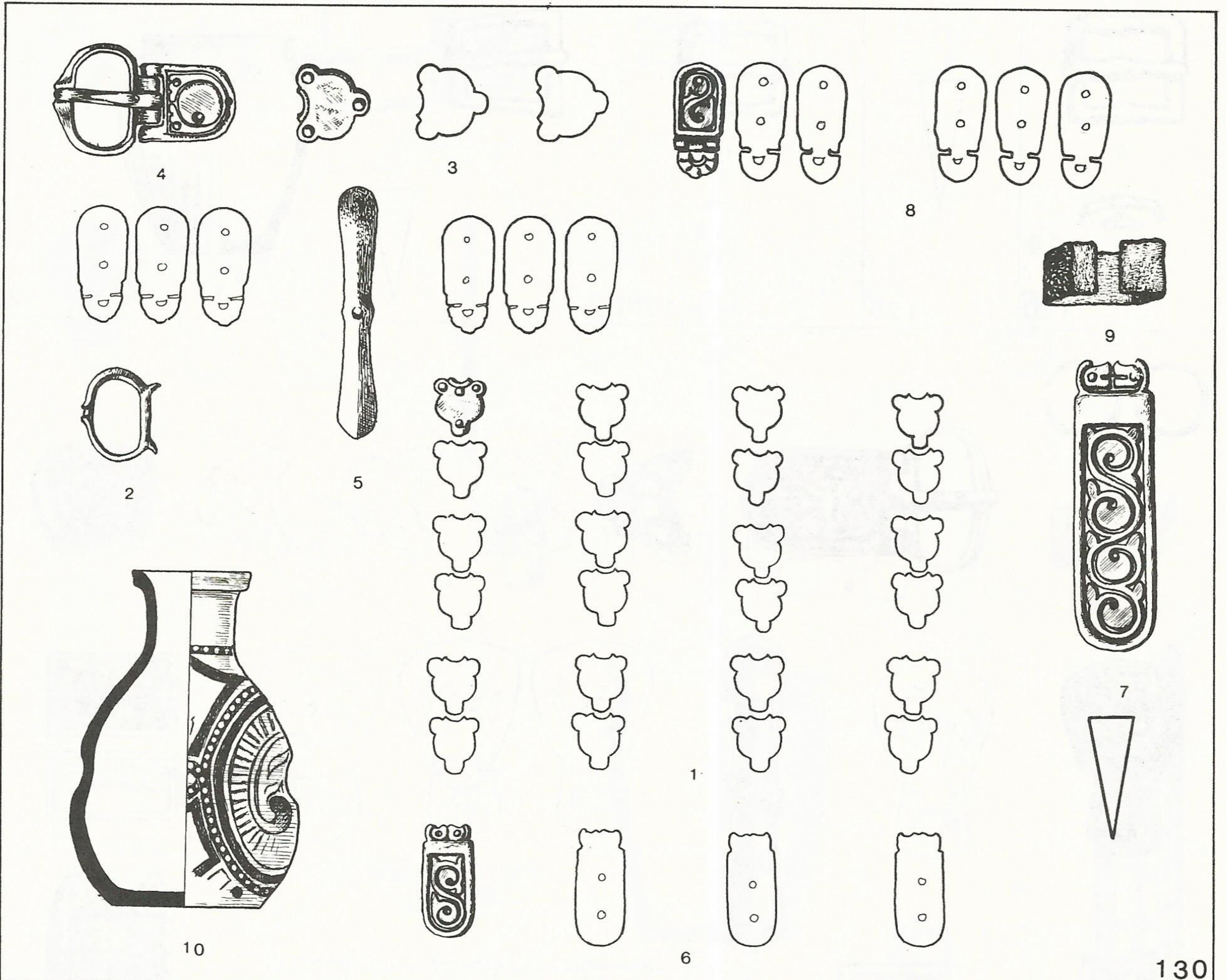
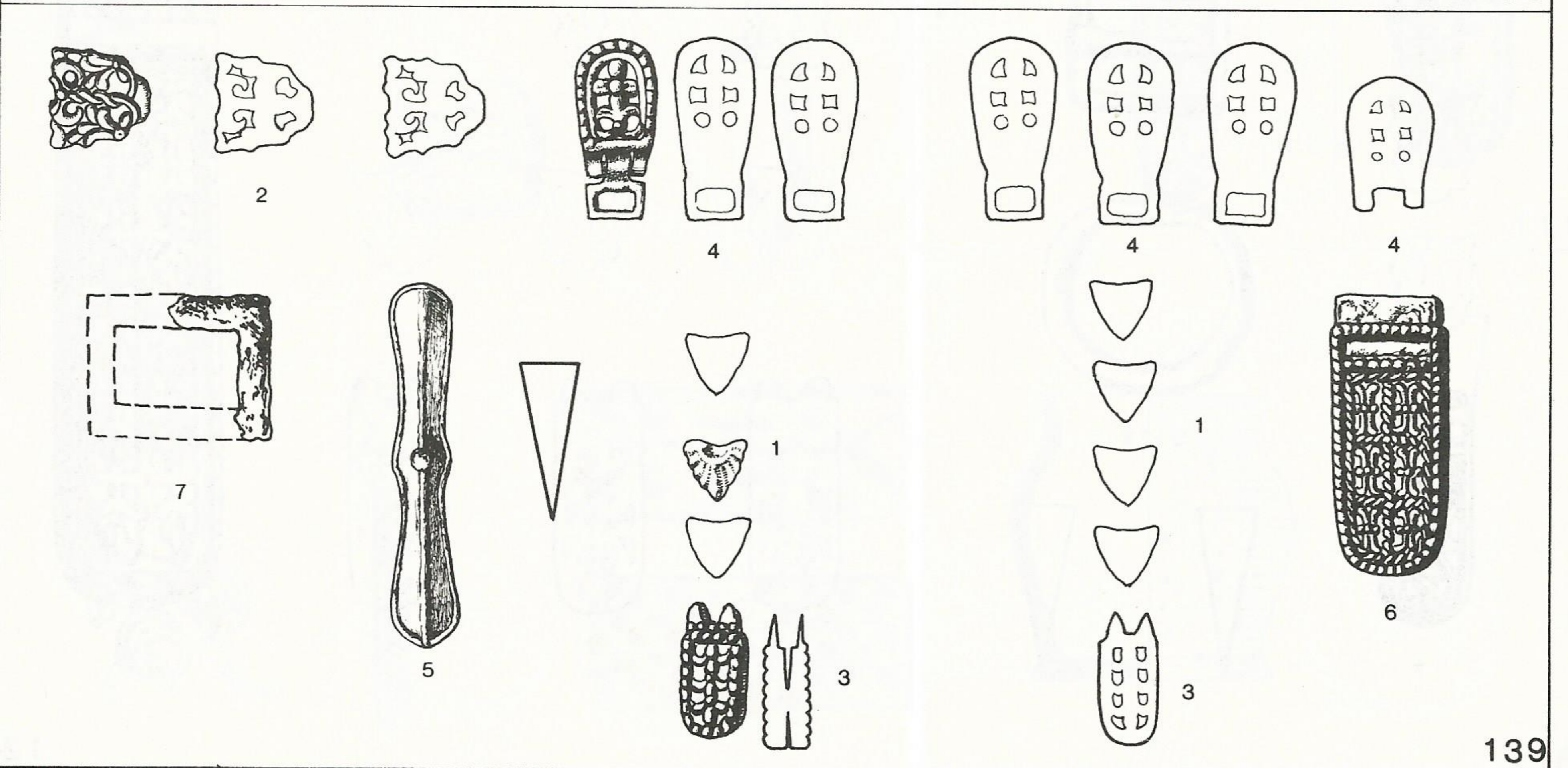

Plate 18 Szeged-Kundomb Graves 120, 124-127



130



139

Plate 19 Szeged-Kundomb Graves 130, 139

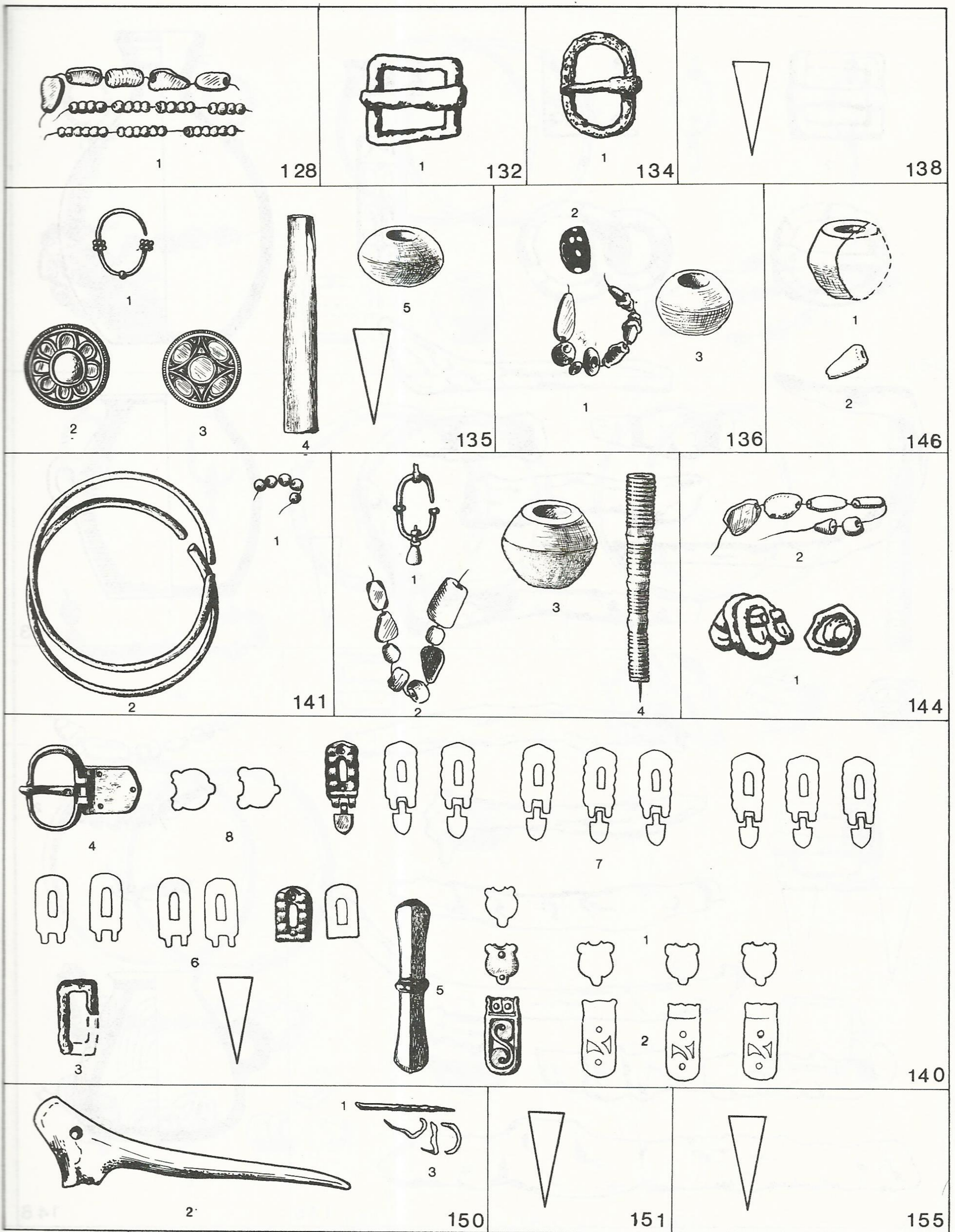

Plate 20 Szeged-Kundomb Graves 128, 132, 134-136, 138, 141, 146

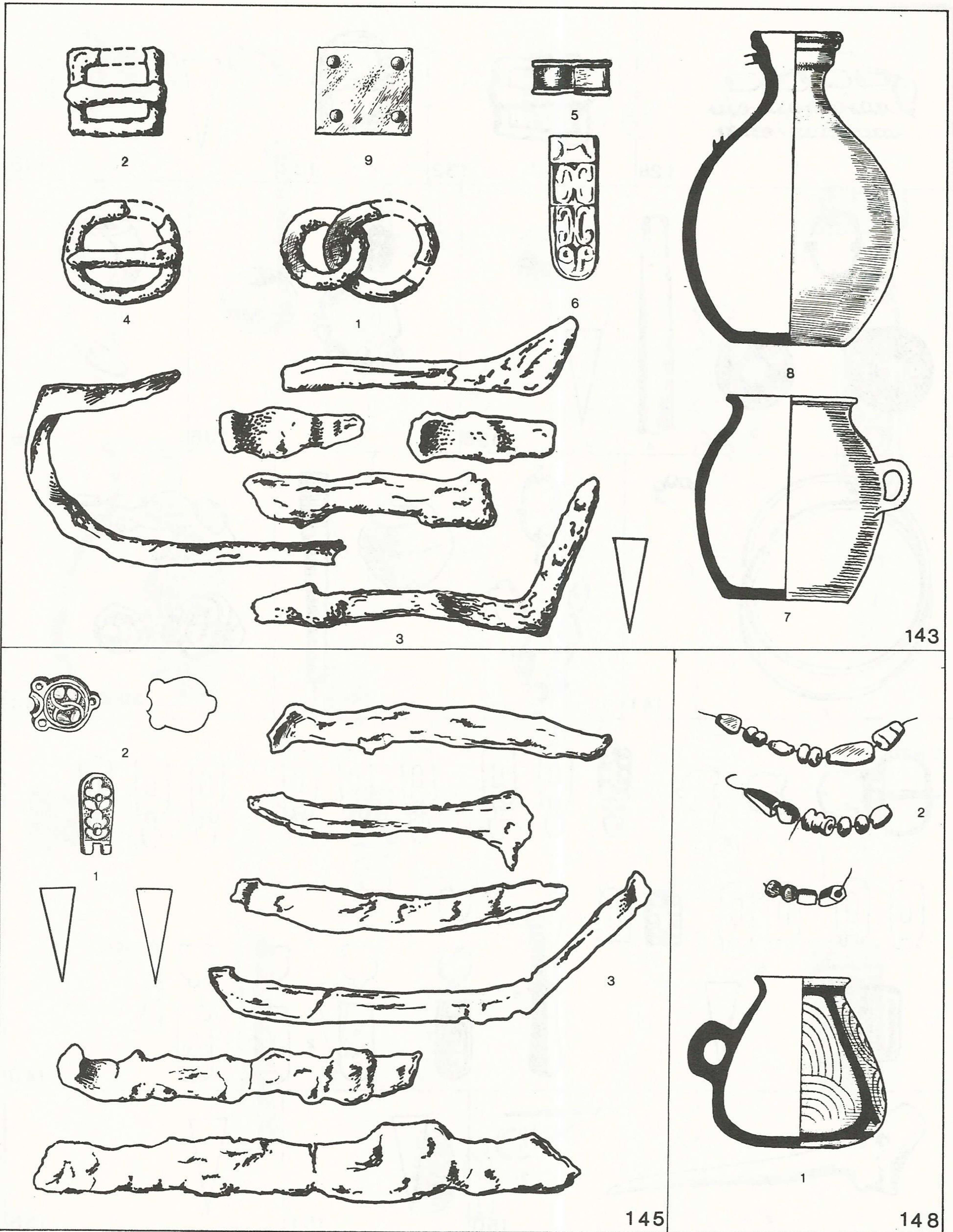

Plate 21 Szeged-Kundomb Graves 140, 142-145, 148, 150, 151, 155

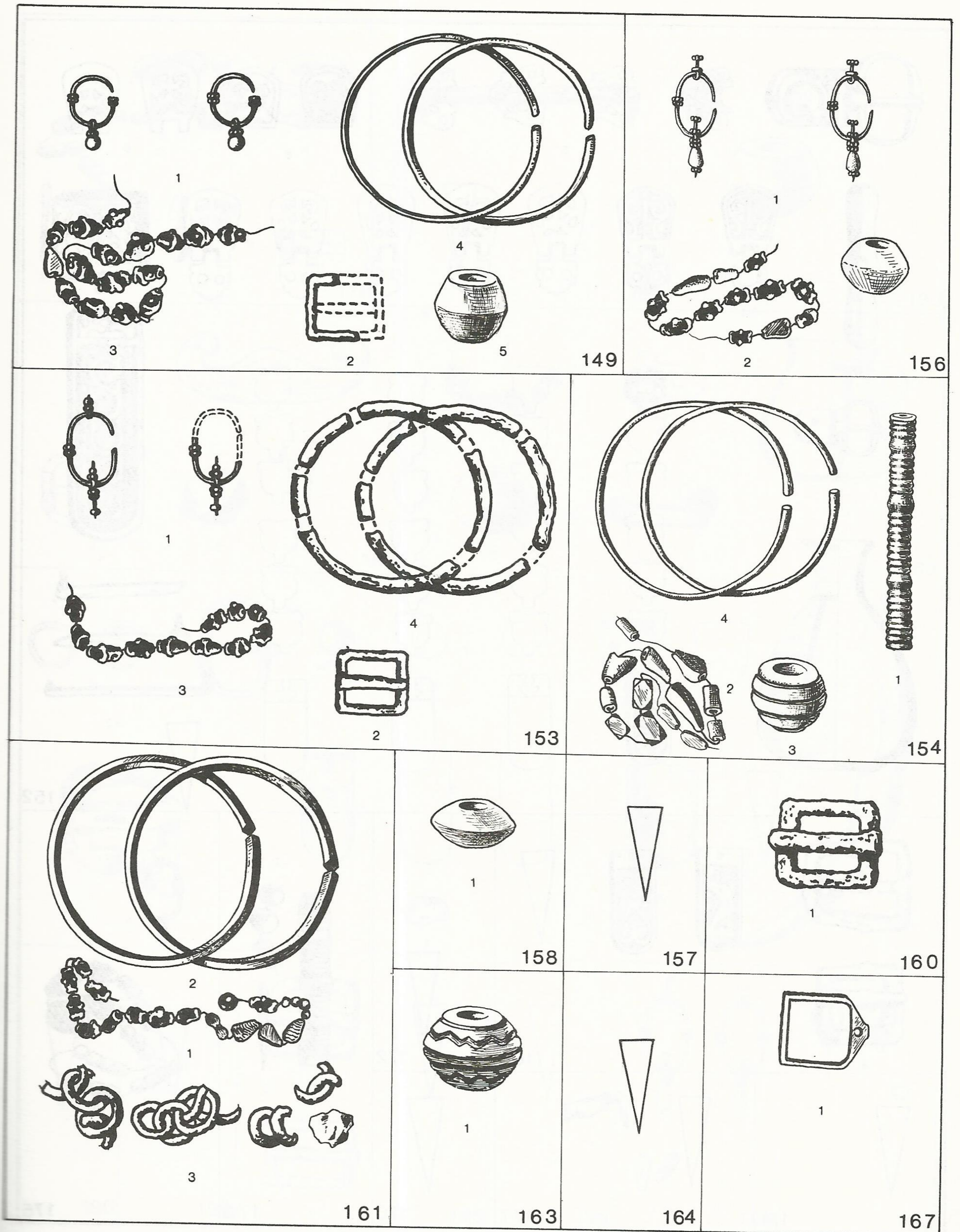

Plate 22 Szeged-Kundomb Graves 149, 153, 154, 156-158

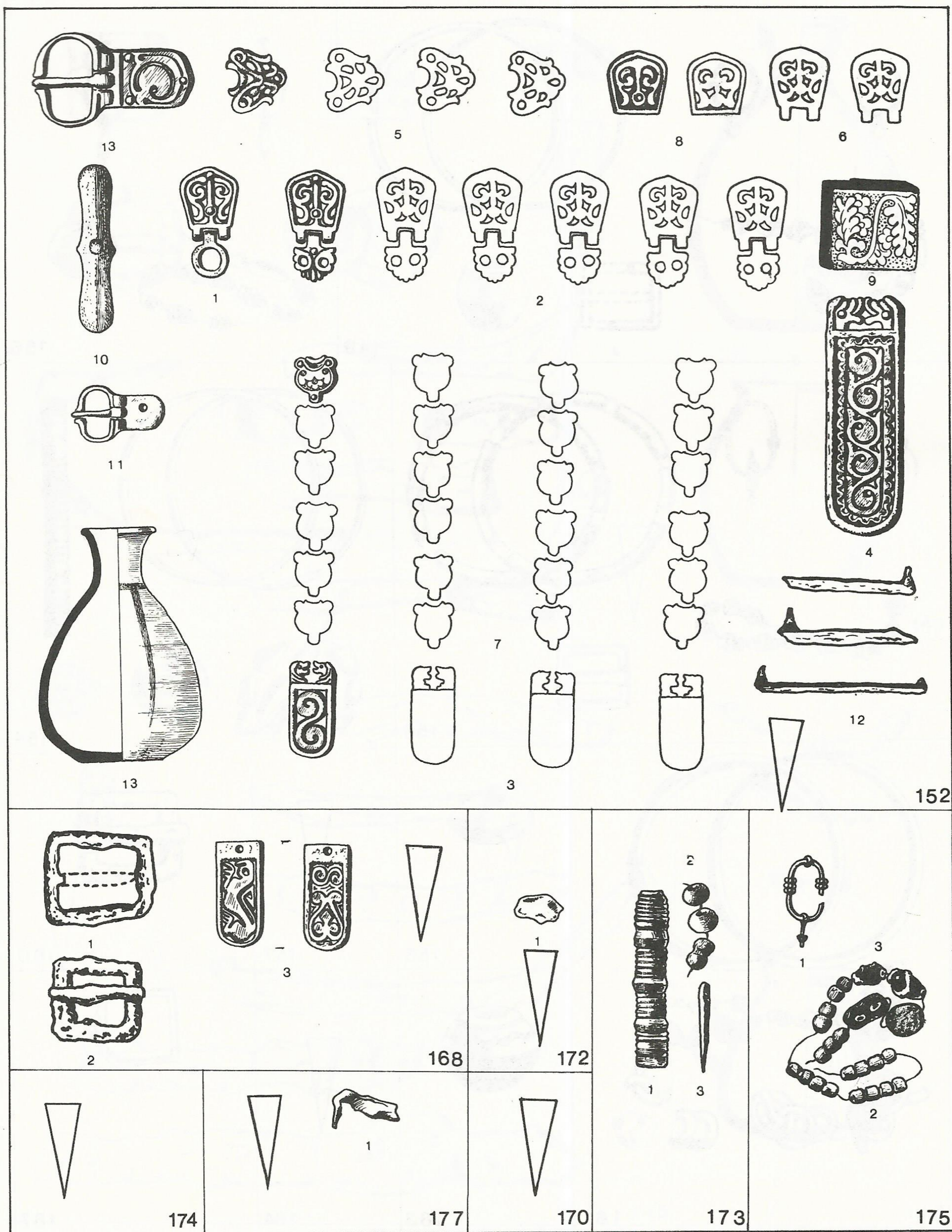

Plate 23 Szeged-Kundomb Graves 152, 168, 170, 172, 173-175, 177

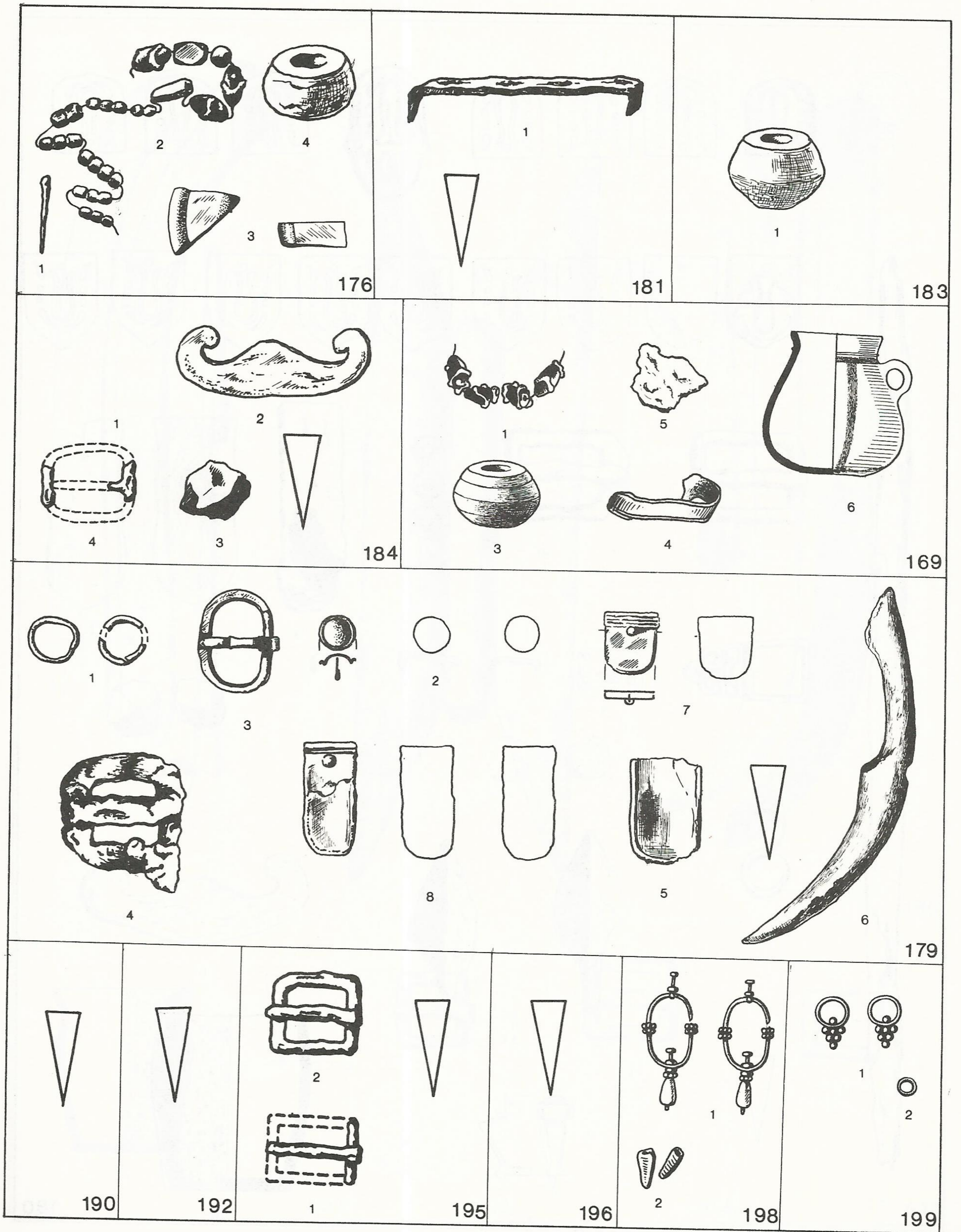

Plate 24 Szeged-Kundomb Graves 169, 176, 179, 181, 183, 184, 190, 192, 195, 196

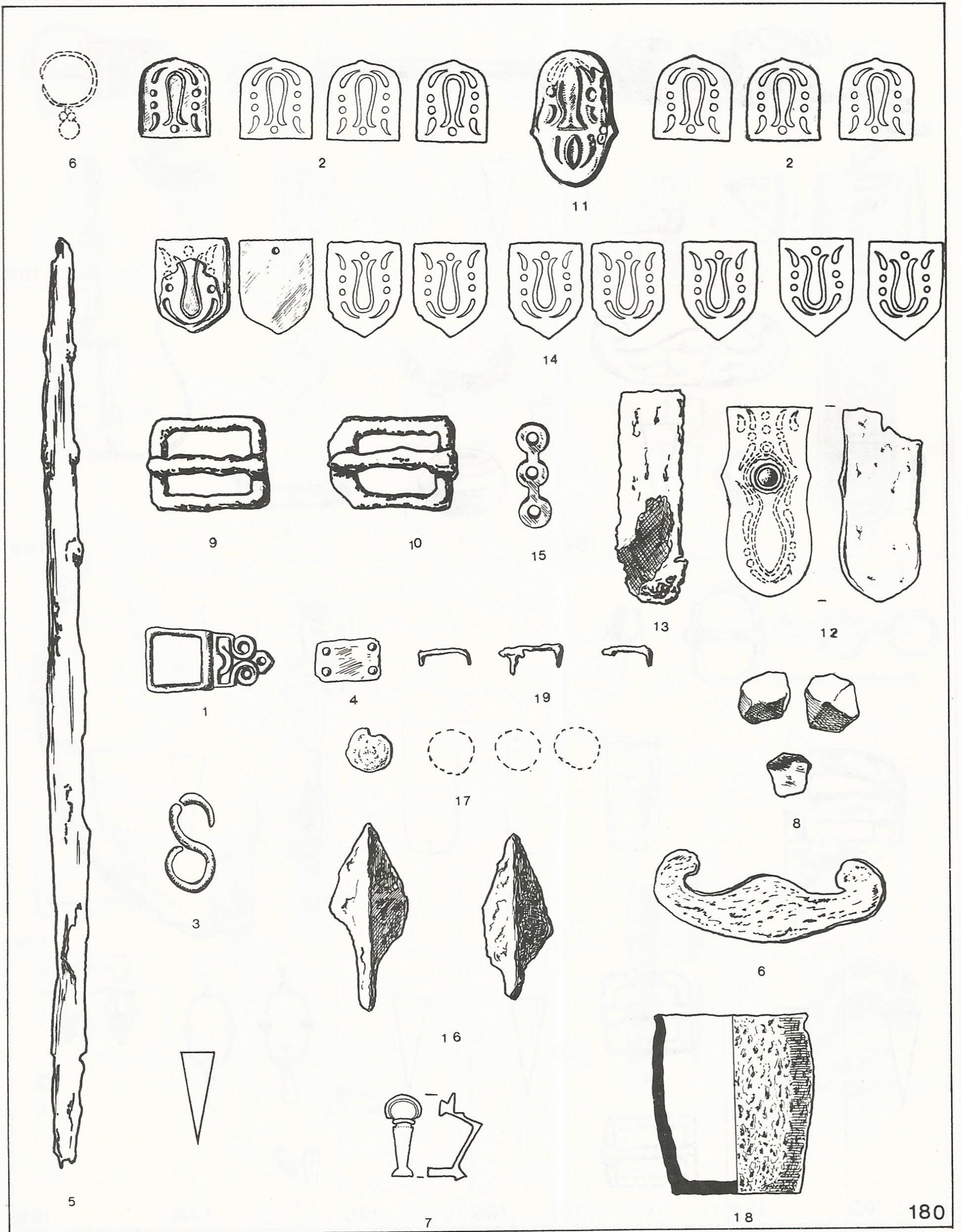

Plate 25 Szeged-Kundomb Grave 180

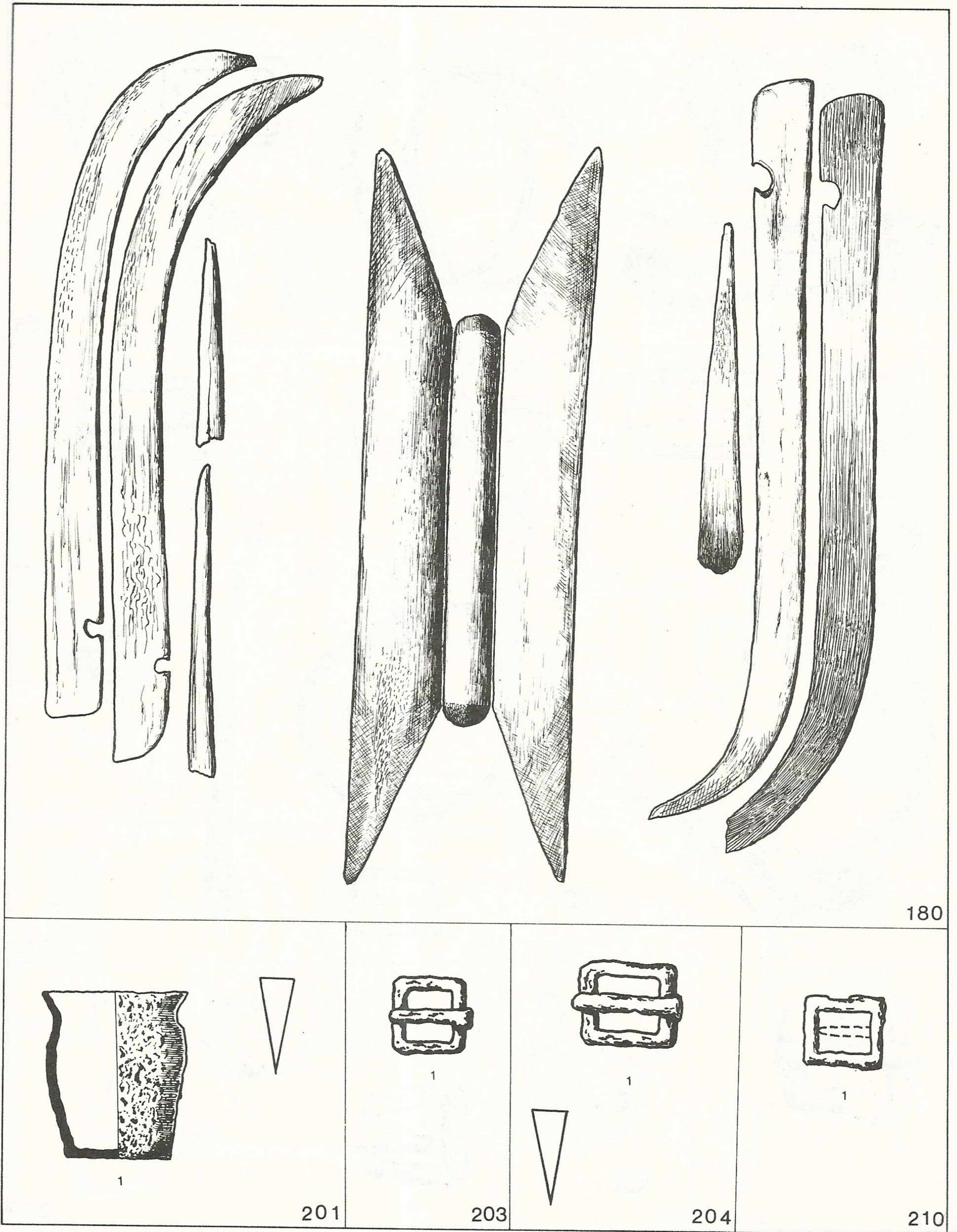

Plate 26 Szeged-Kundomb Graves 180, 201, 203, 204, 210

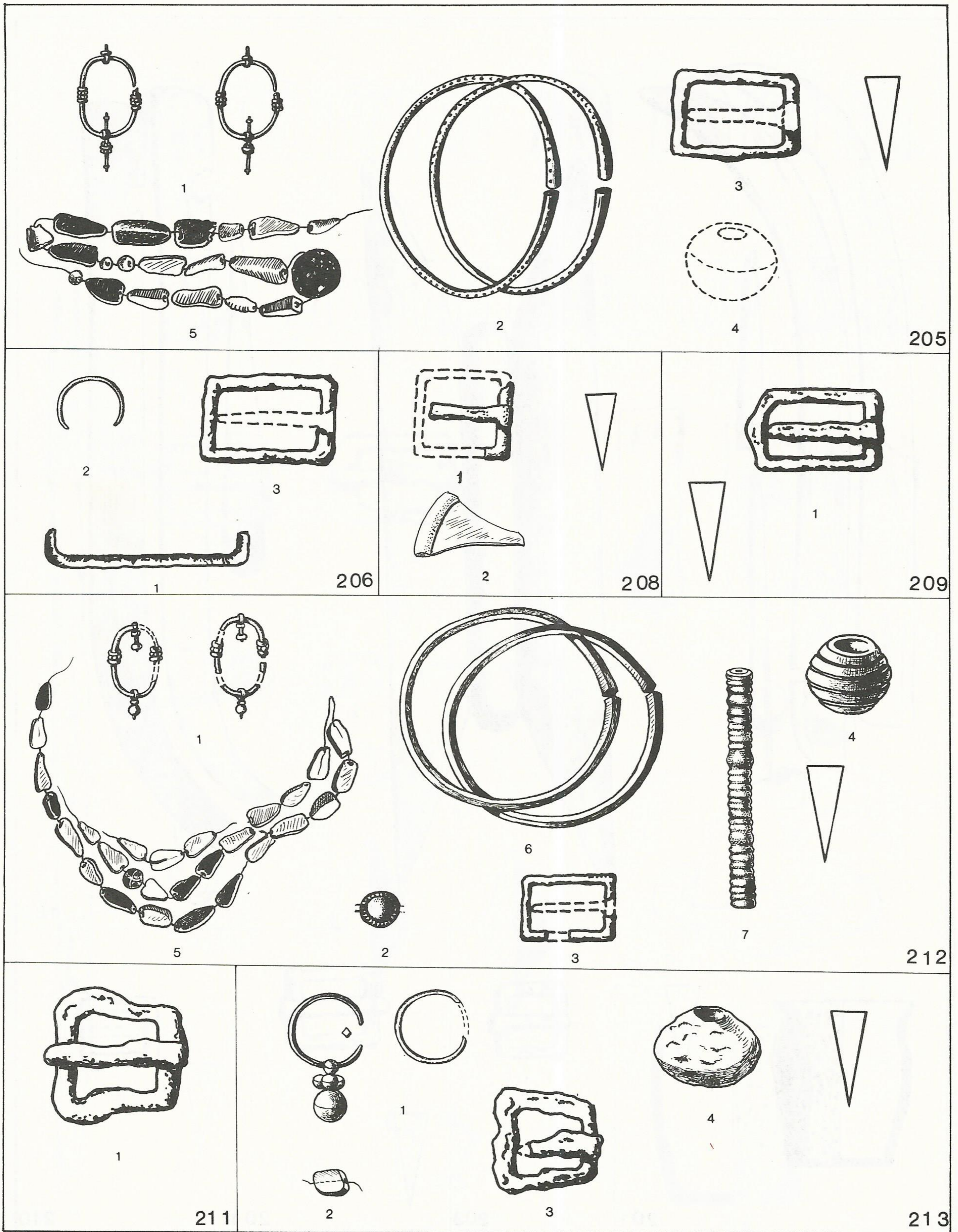

Plate 27 Szeged-Kundomb Graves 205, 206, 208, 209, 211, 213



Plate 28 Szeged-Kundomb Graves 214, 215, 217-219

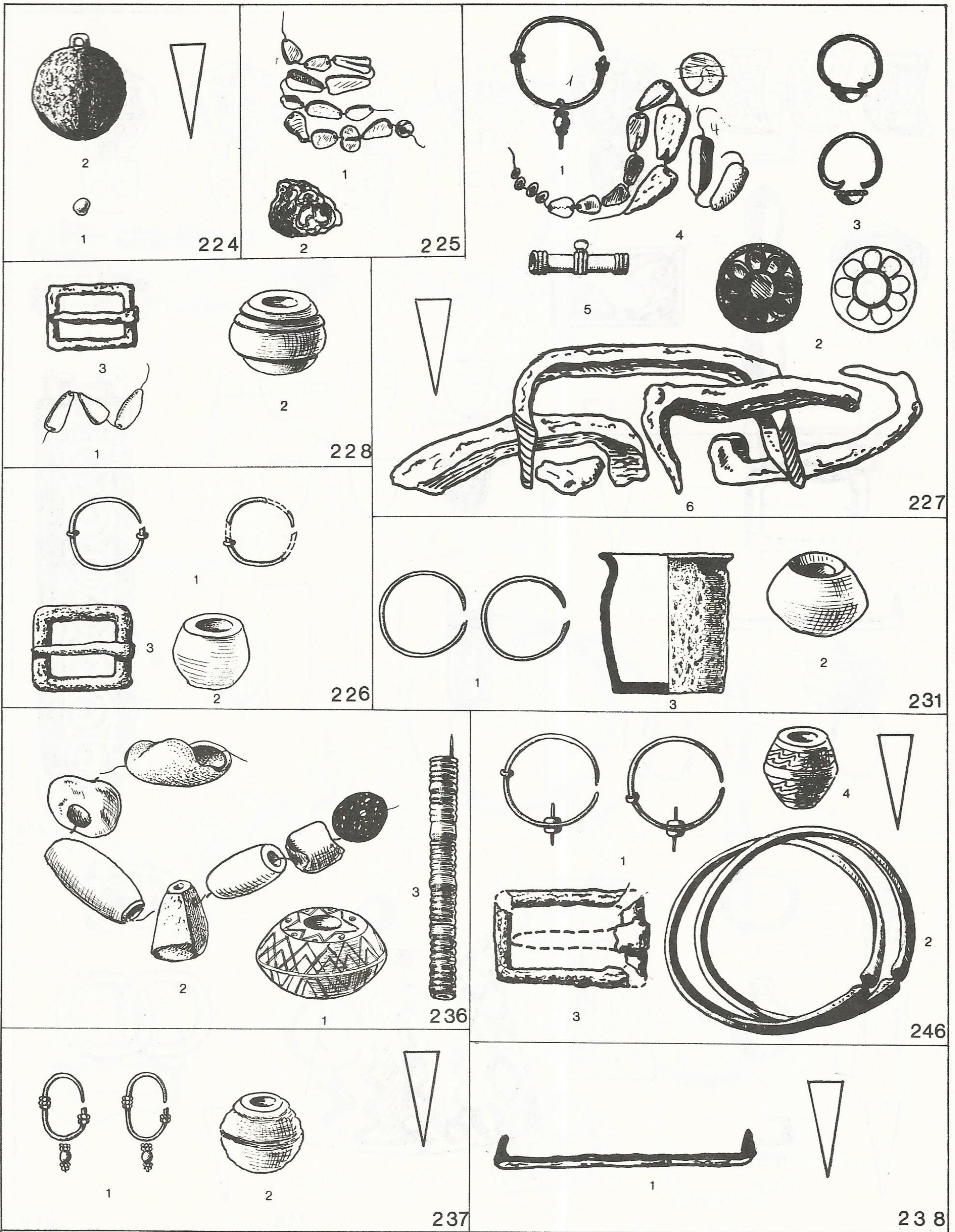

Plate 29 Szeged-Kundomb Graves 224-228, 231, 236-238, 246

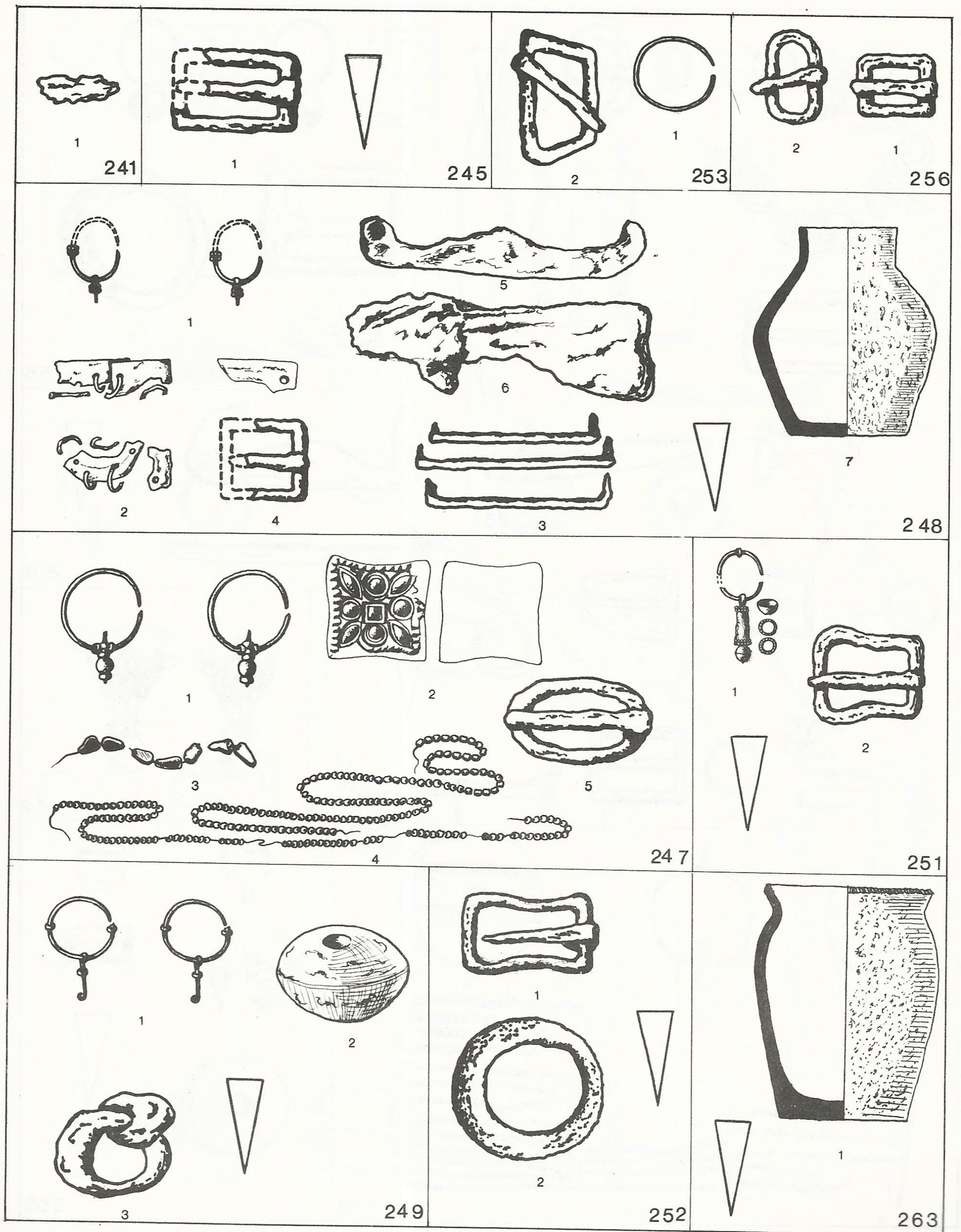

Plate 30 Szeged-Kundomb Graves 241, 245, 247-249, 251-253, 256, 263

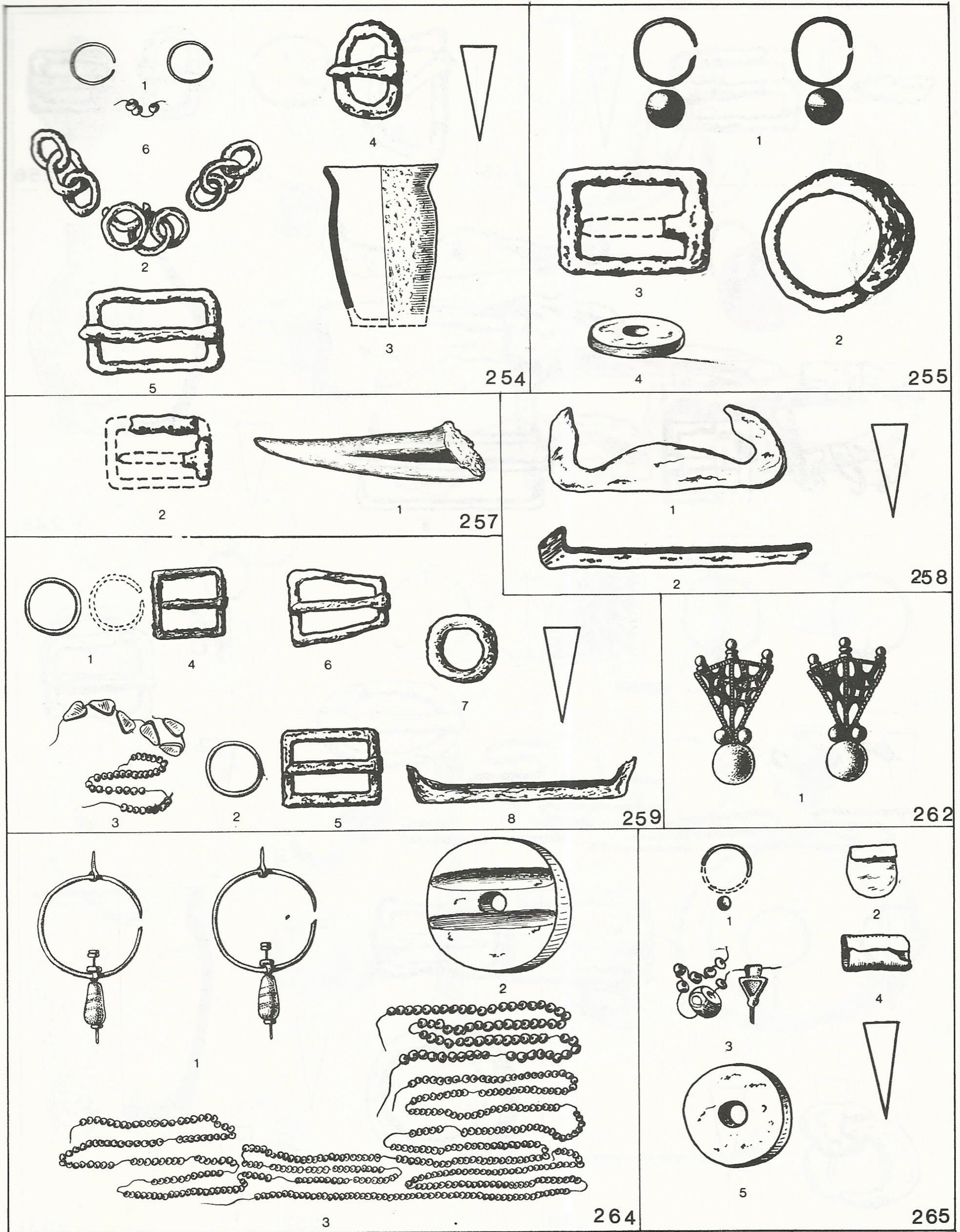

Plate 31 Szeged-Kundomb Graves 254, 255, 257-259, 262-264

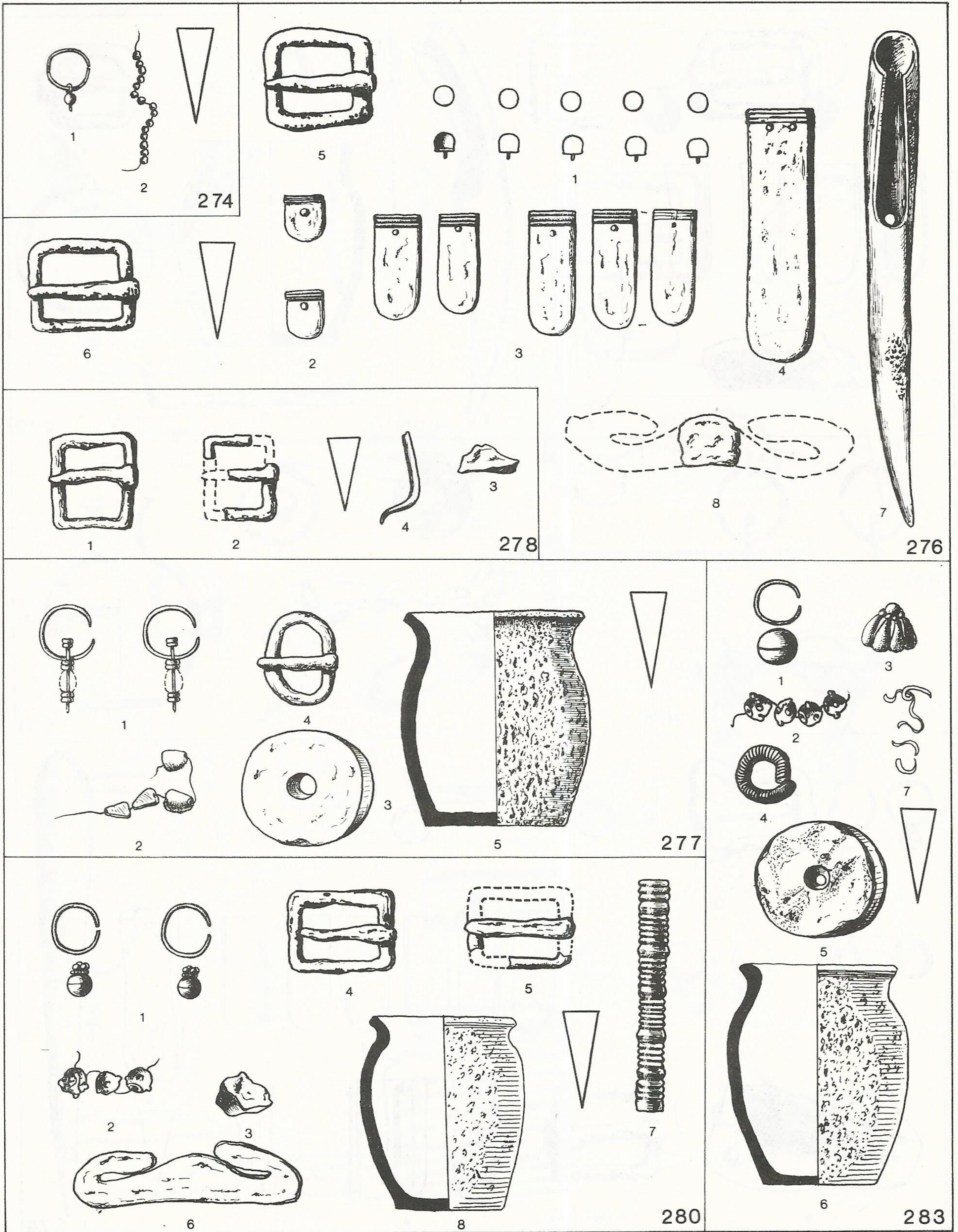
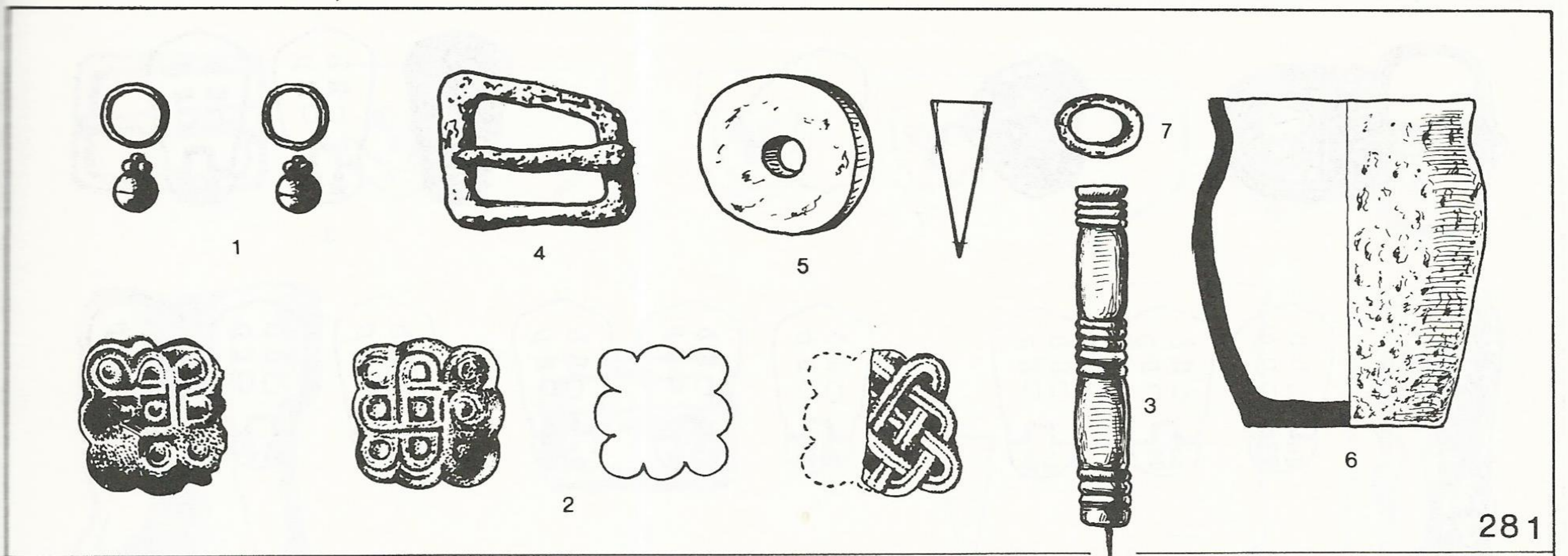
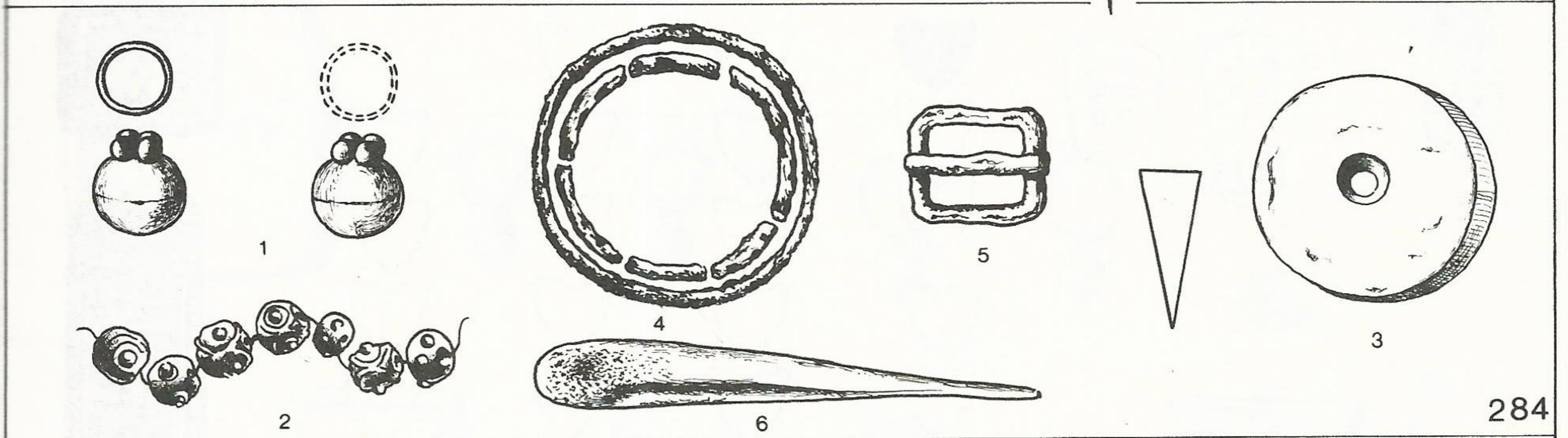

Plate 33 Szeged-Kundomb Graves 276, 277, 278, 280



281



284

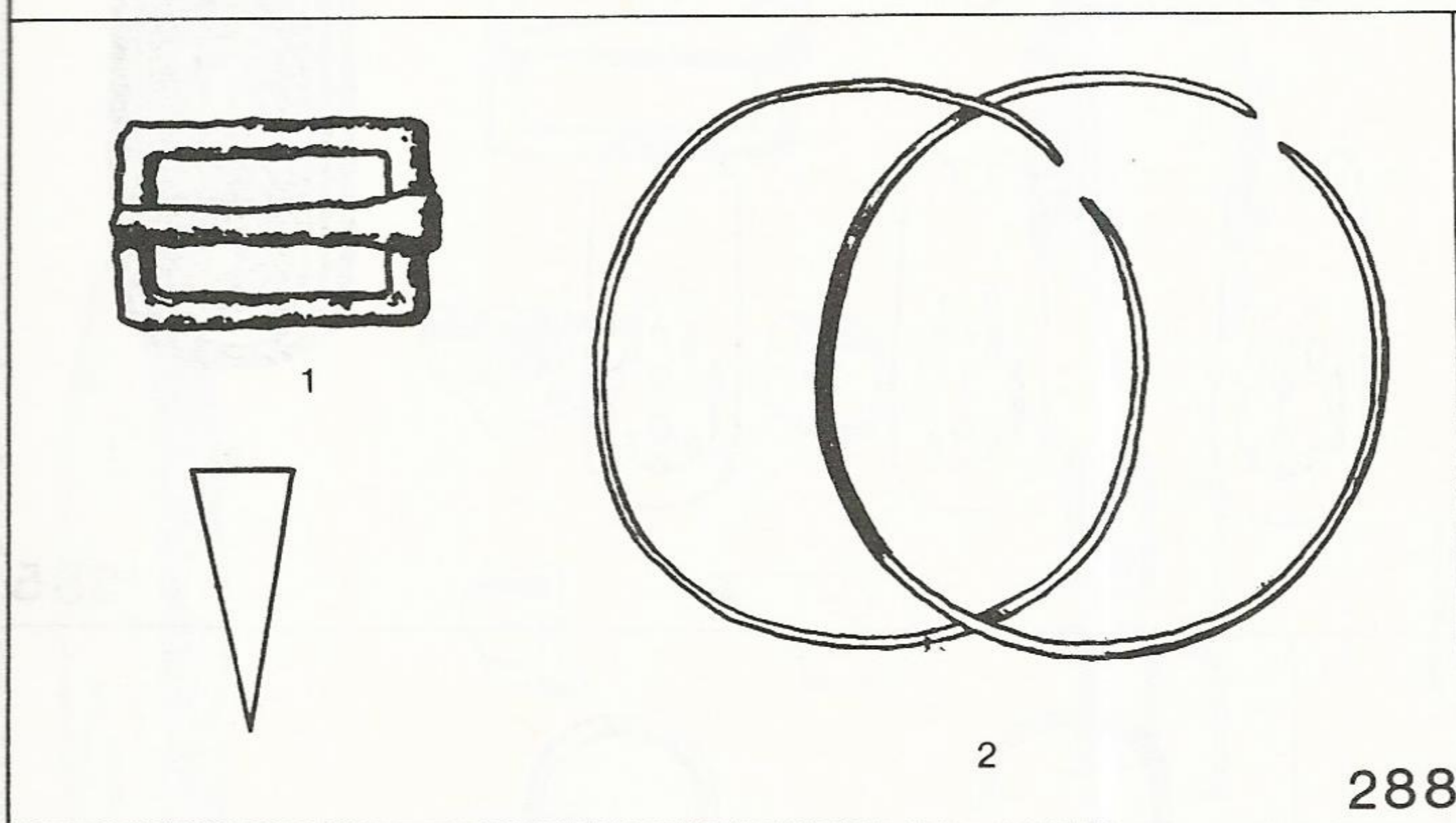

288

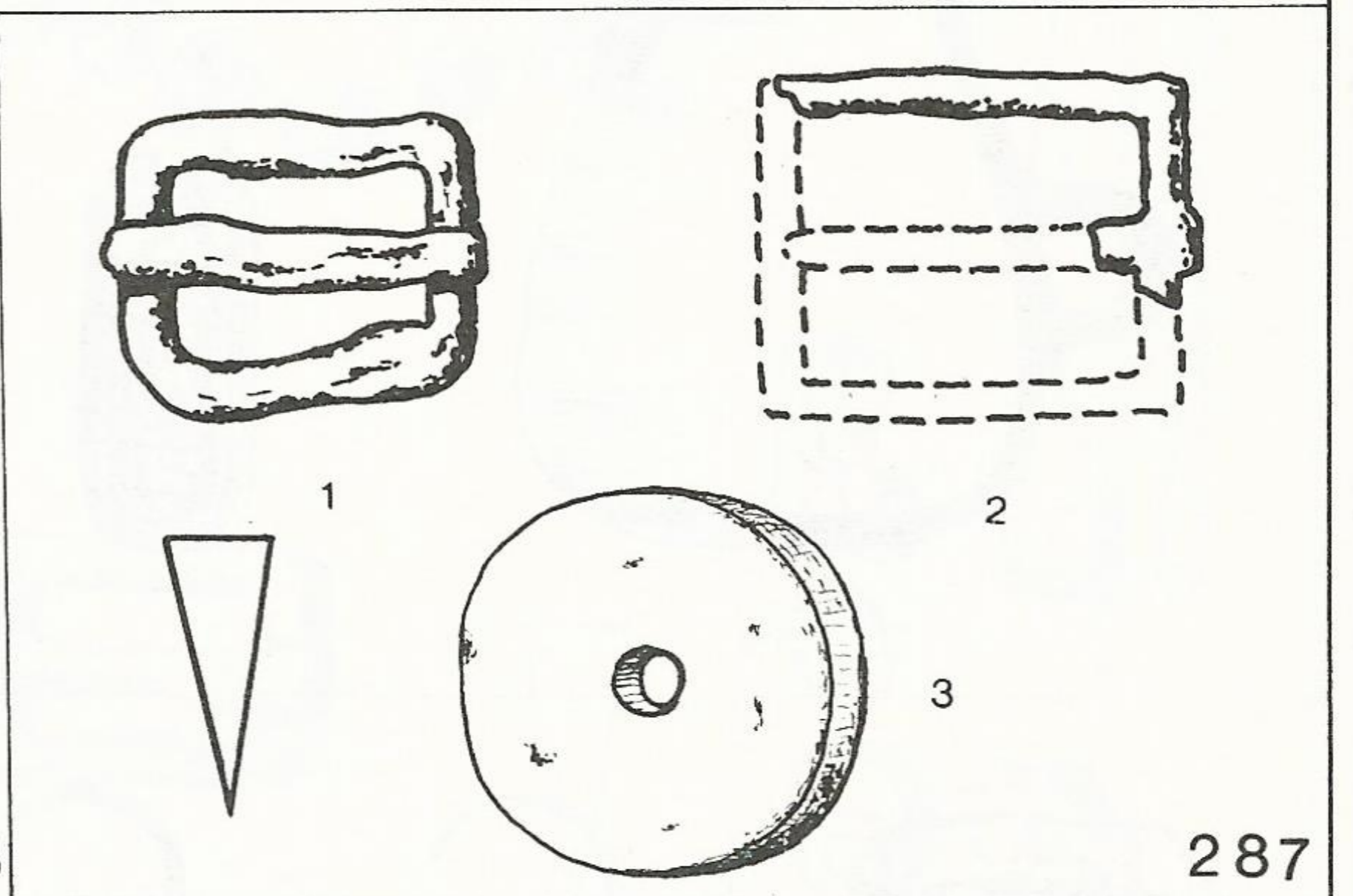

287

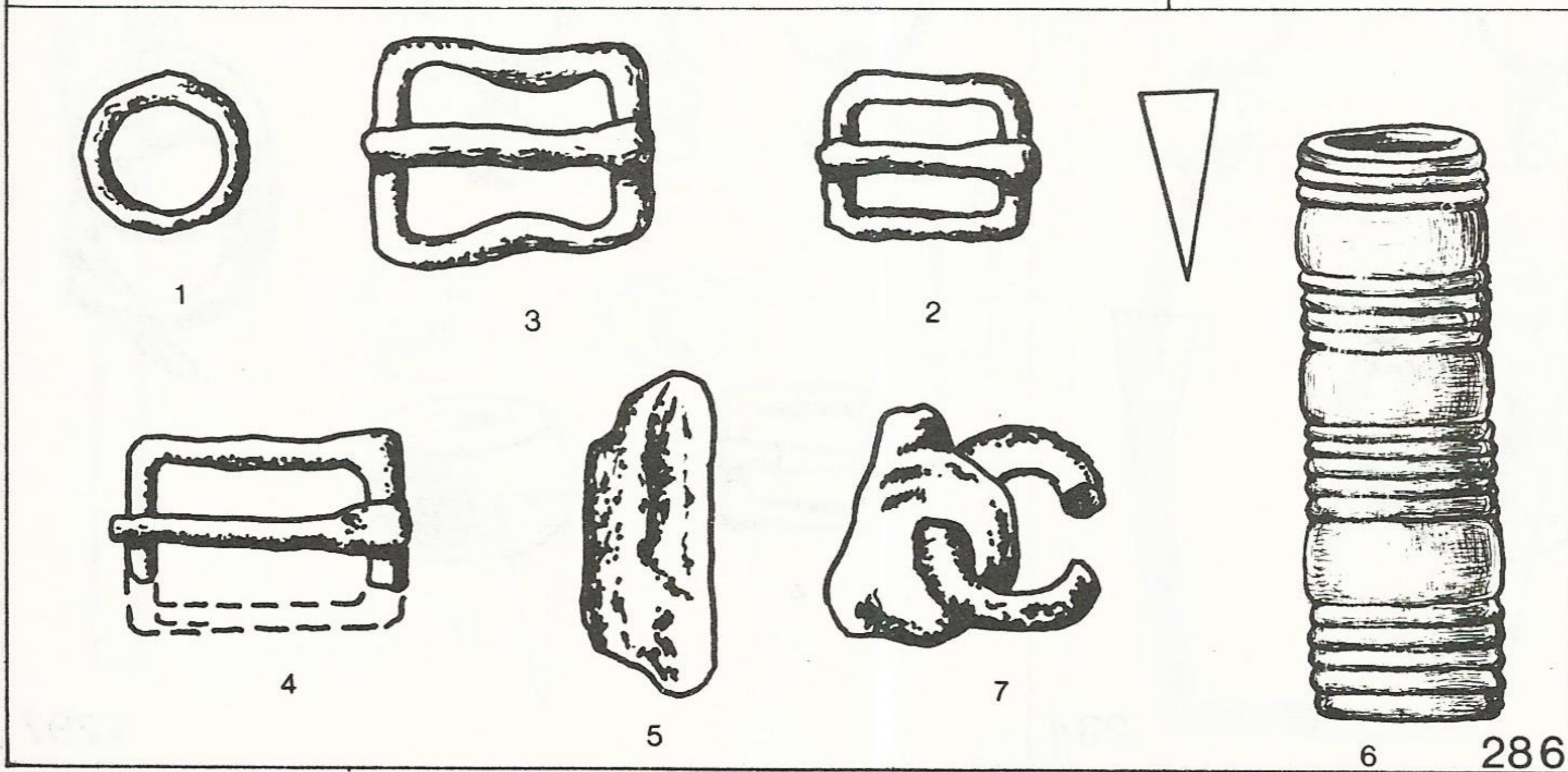

286

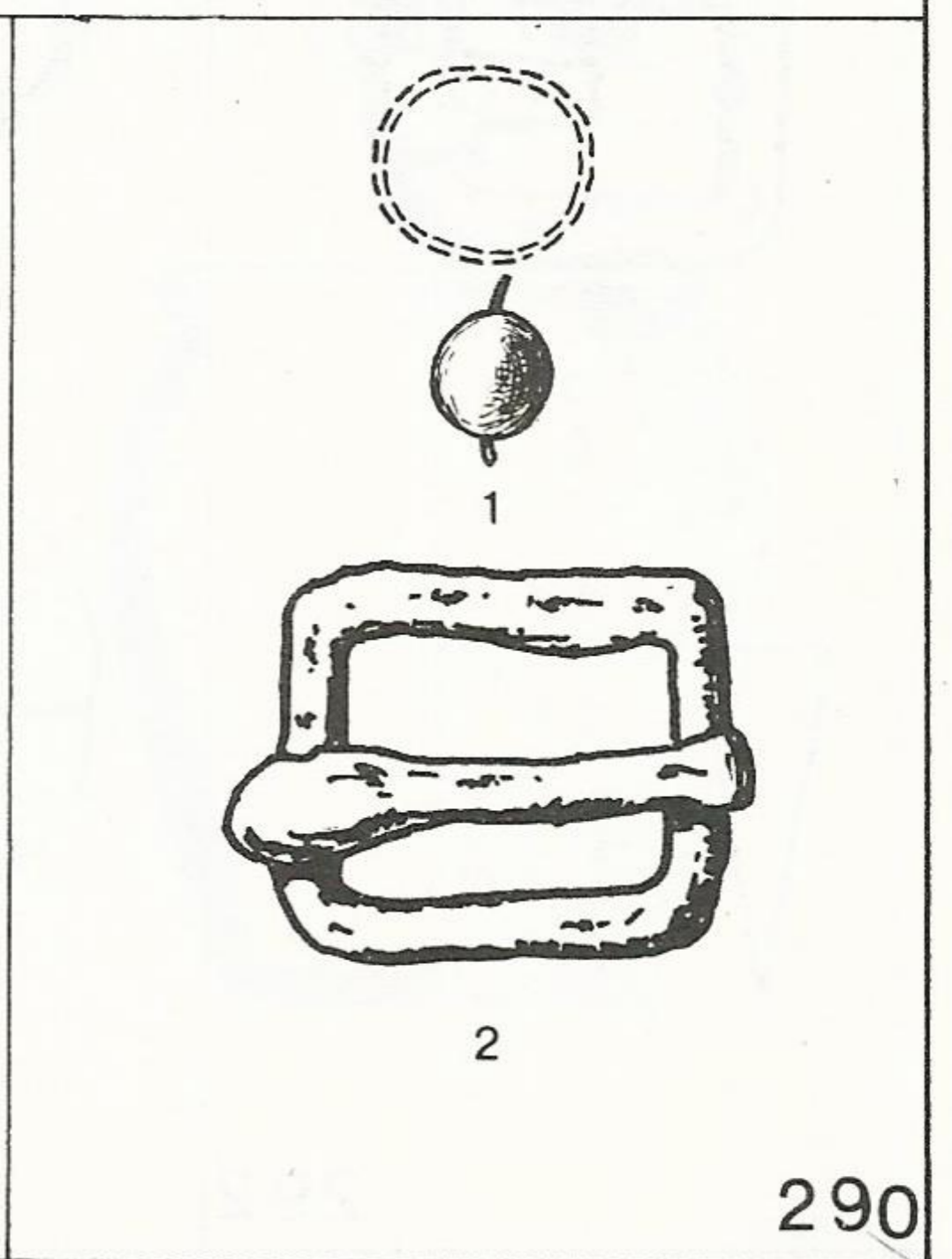

290

Plate 34 Szeged-Kundomb Graves 281, 284, 286-288, 290

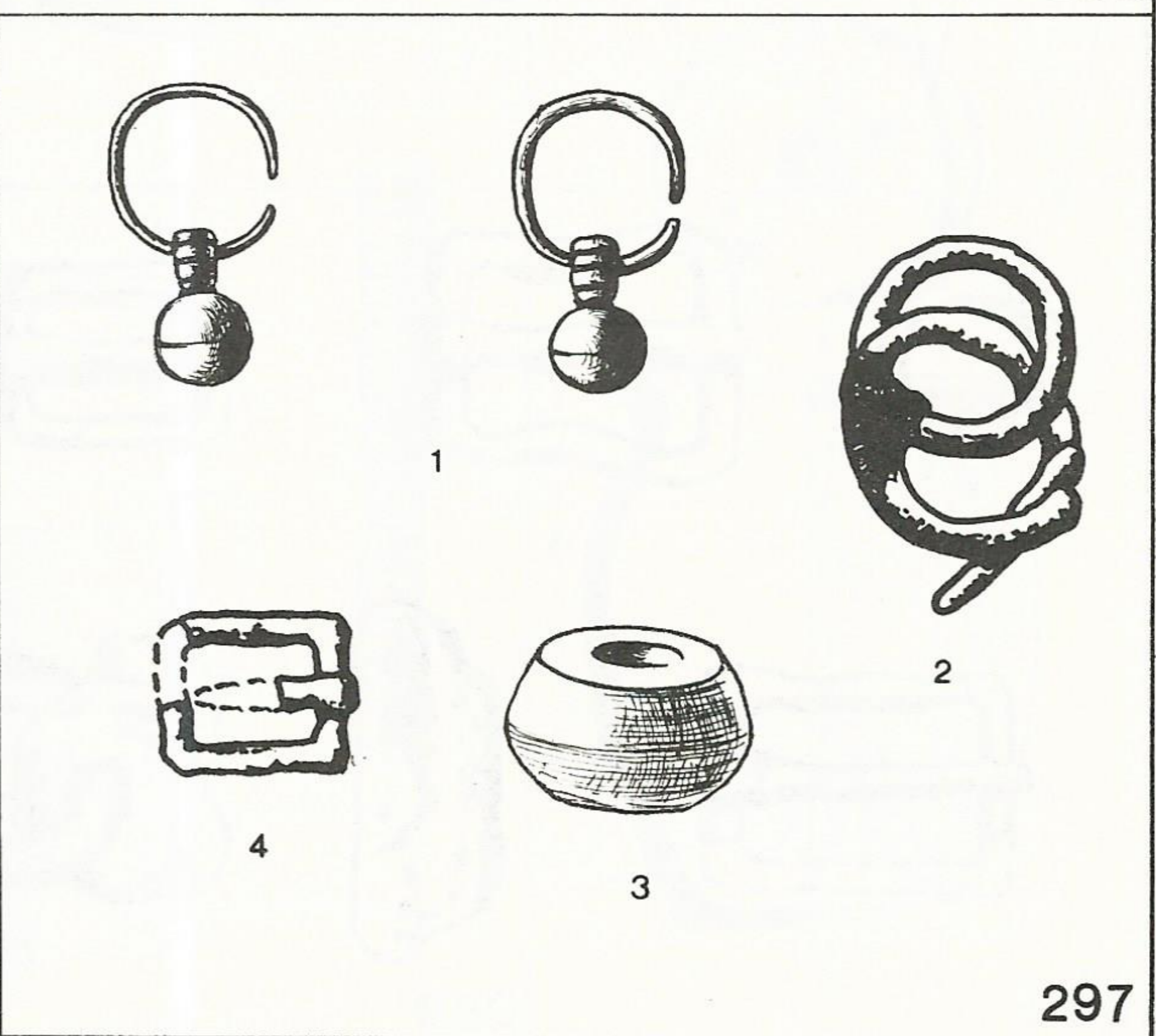
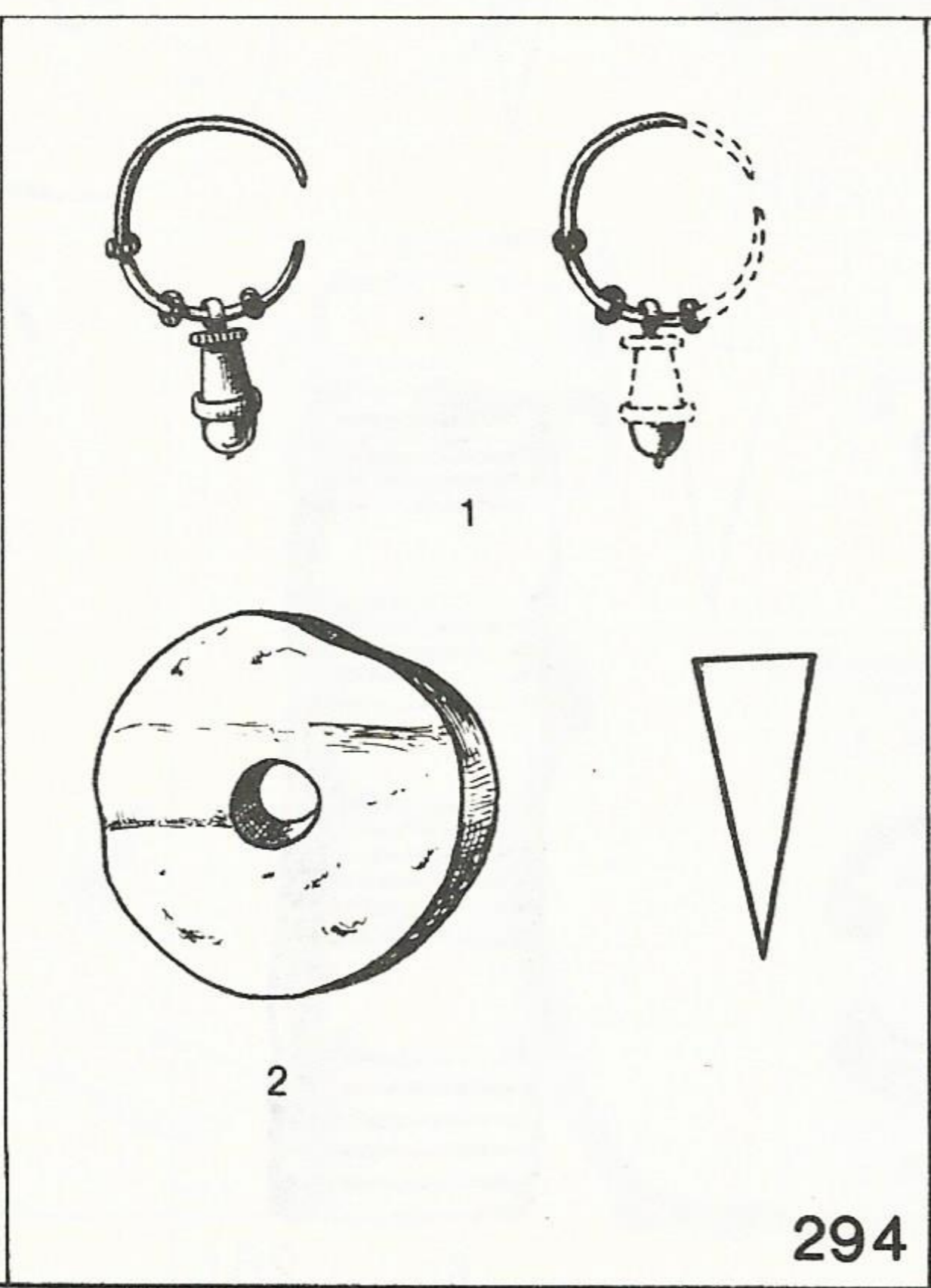
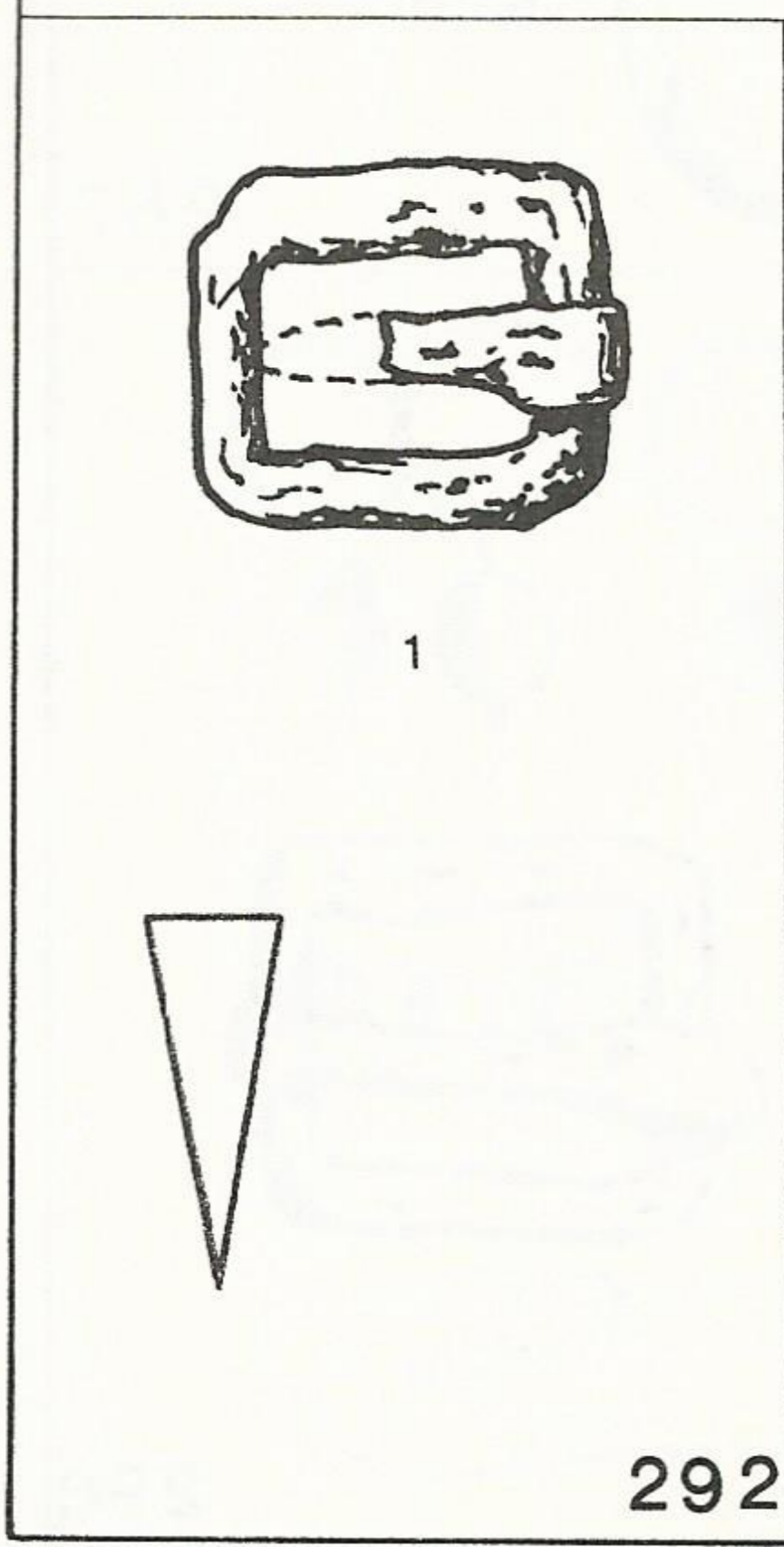
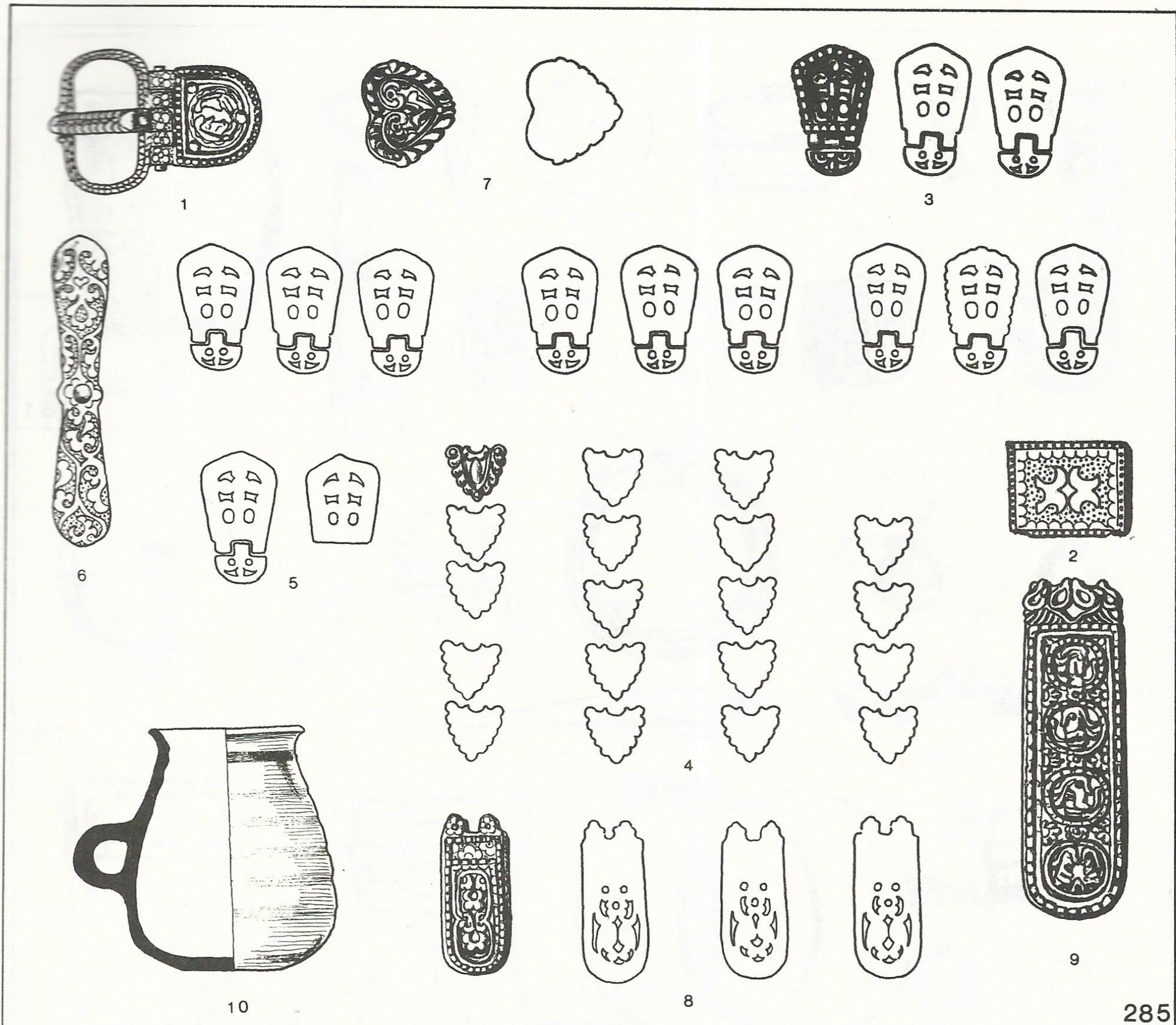

Plate 35 Szeged-Kundomb Graves 292, 294, 297

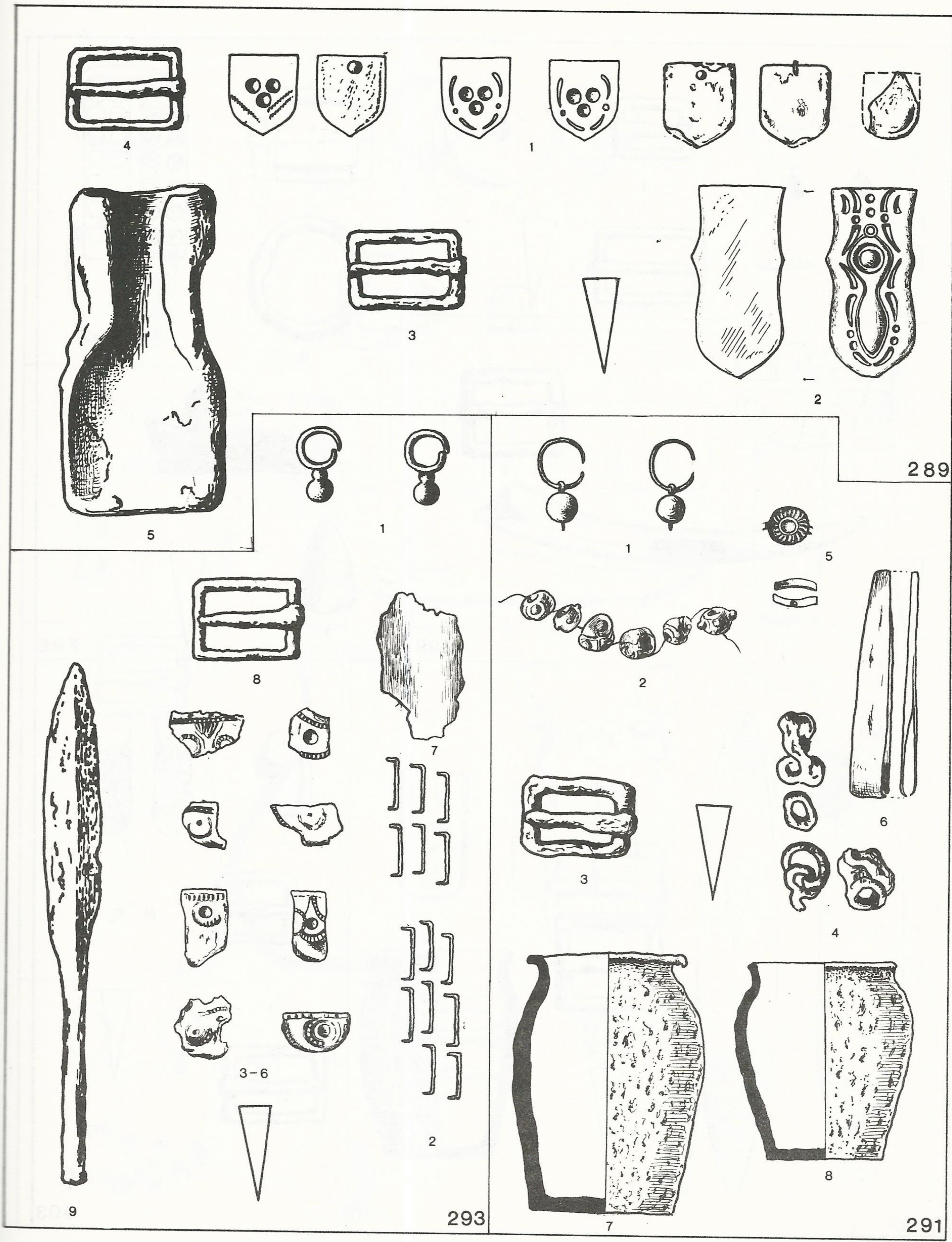

Plate 36 Szeged-Kundomb Graves 289, 291, 293

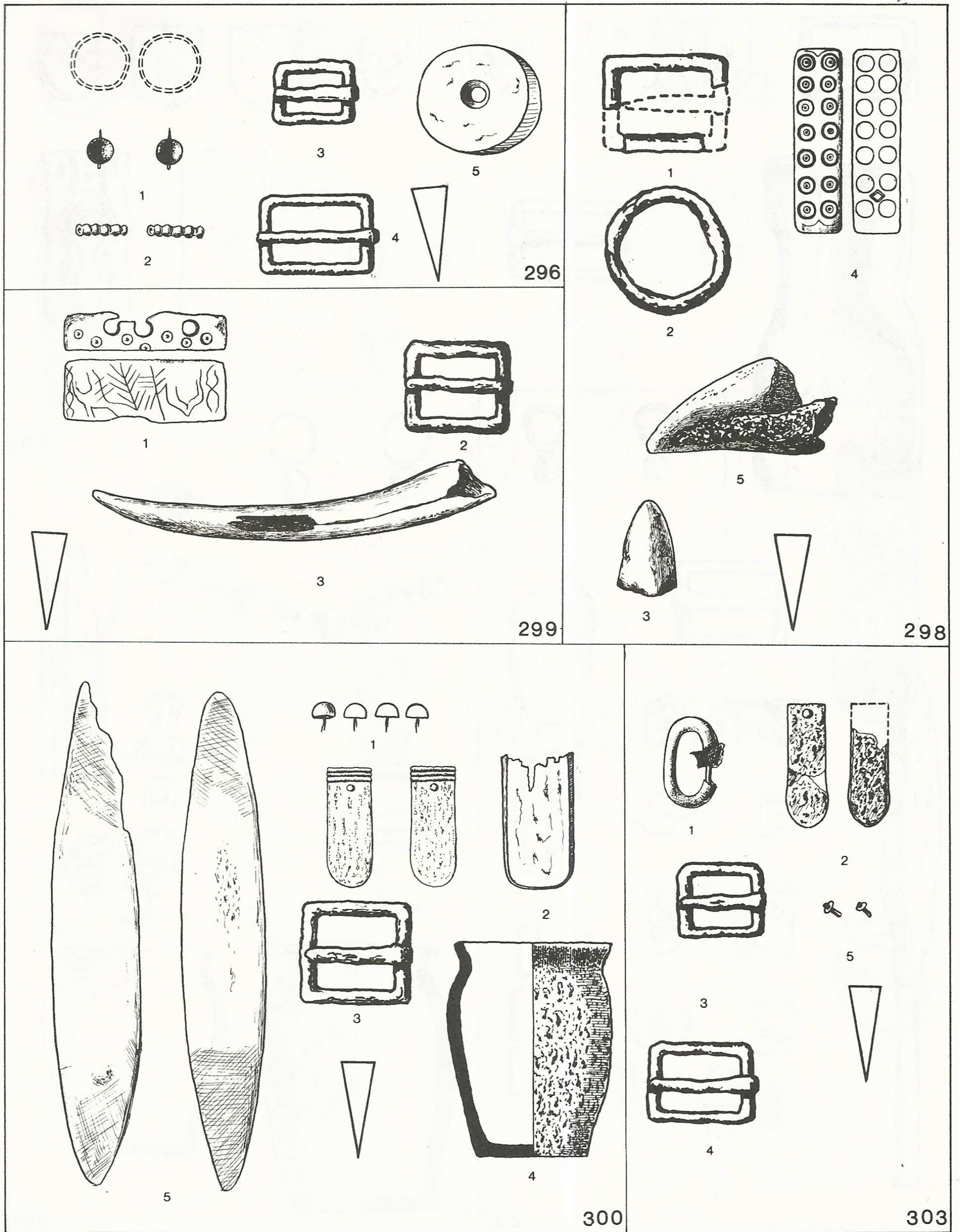

Plate 37 Szeged-Kundomb Graves 296, 298, 299, 300

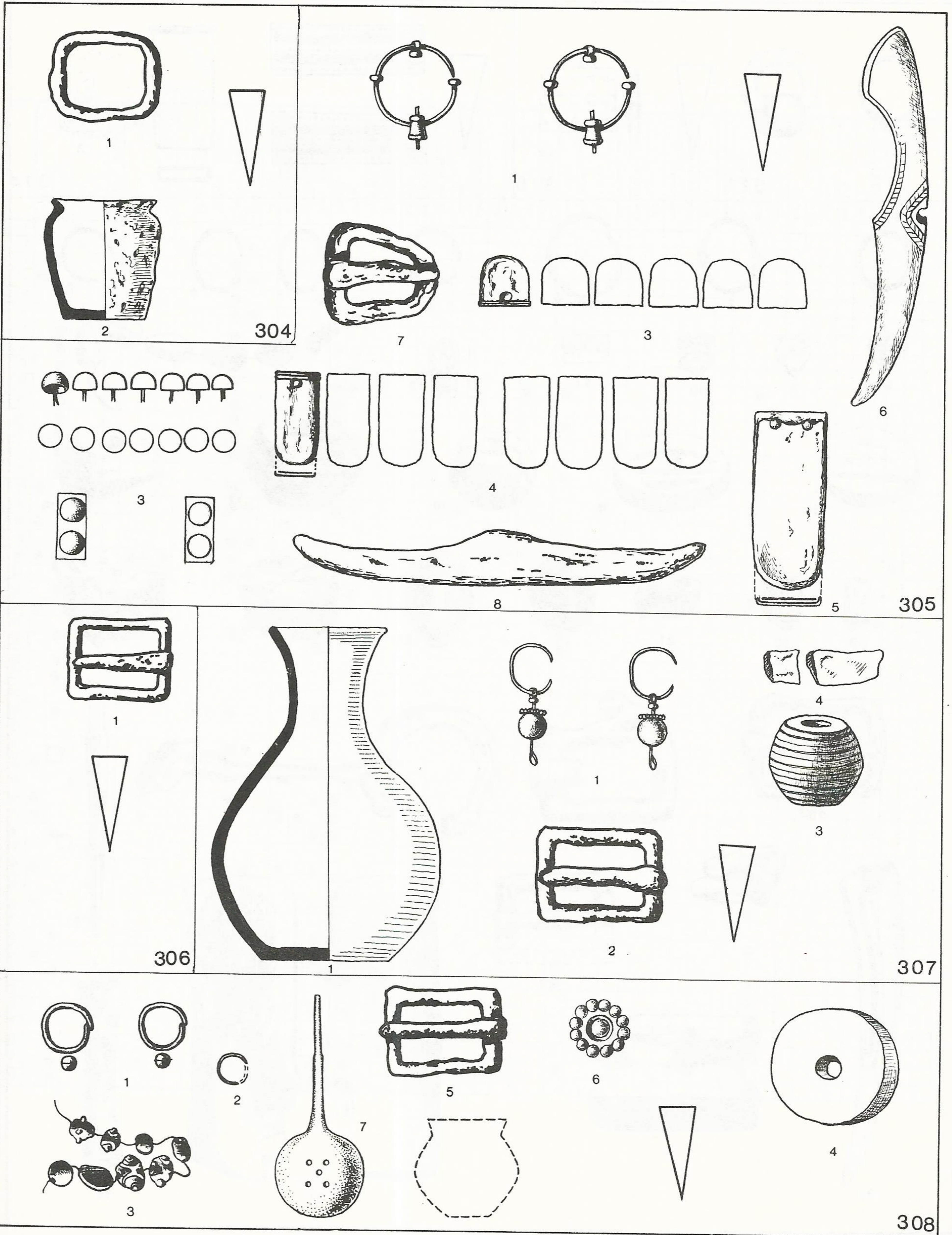

Plate 38 Szeged-Kundomb Graves 304, 305, 306, 3,7, 308

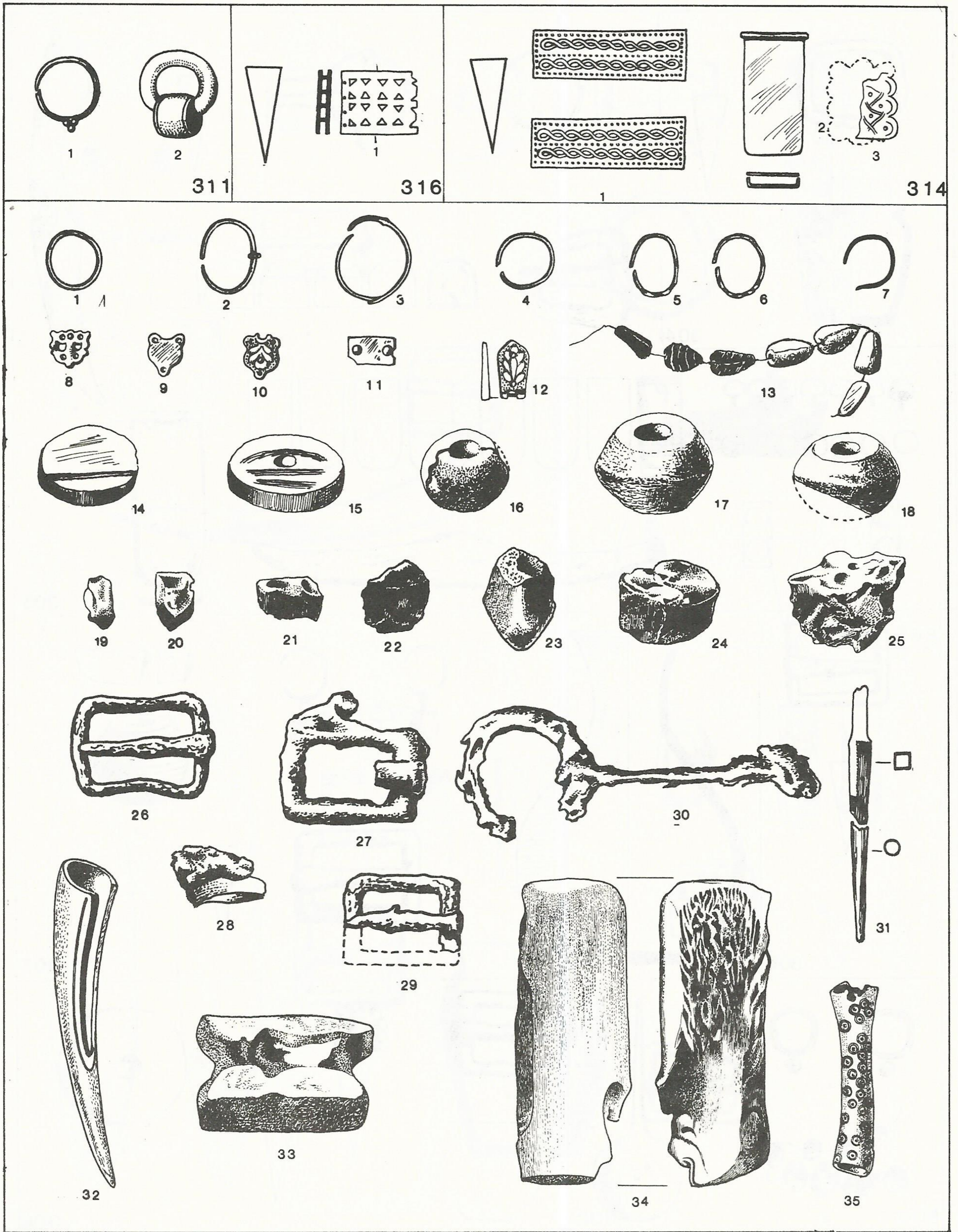

Plate 39 Szeged-Kundomb Graves 311, 314 and stray finds

THE SZEGED-MAKKOSERDŐ CEMETERY

Ágnes Salamon

I. EXCAVATION AND SITE

1. *The excavation of the cemetery*

The excavations in Szeged-Makkoserdő were started in 1930 by Ferenc Móra, that time director of the Szeged Museum. Work was started in front of Dr. I Balla's plot, and Móra excavated 201 graves. The excavations were continued in 1942 when D. Csallány then Director of the Szeged Museum discovered further graves numbered from 202 to 399. The excavation work was carried out jointly with the Szeged University, Institute for Anthropology, and the skeletal material was forwarded to the said Institute.¹ Móra's excavation had been continued outside the fence bordering the plot belonging to Dr. Balla, Csallány's excavation started at the inner side of the fence and was continued in the parts not built upon of the courtyard.

The graves excavated in the Makkoserdő cemetery belong to the Avar Period only partly; earlier than the Avar burials there had been a Sarmatian cemetery, then, after the Avar Period burials another cemetery, of the Árpád Dynasty Period, was established. The number of Sarmatian graves was 39,² that of the Árpád Dynasty Period 31.³ Within the Avar Period cemetery 267 graves were excavated. The excavation records and some photos taken in the course of the works are registered in the Móra Ferenc Museum in Szeged. As mentioned above, the skeletal material reached the Szeged University, Institute of Anthropology.⁴ In the course of the excavations in 1930 and 1932 two sketch plans of the excavated area were made, yet there are some divergences when comparing them. In the first cemetery plan graves 23 and 12, as well as graves 24 and 13 are marked as having grave pits of their own, and the dimensions of grave 38 are not the same as the figures indicated in the description of the grave. In the second cemetery plan — reproduced here — graves 23/12 and 24/13 are represented as united, and grave pit 38 also was lengthened (For these issues cf. sections Grave Pit and Horseman's Grave.). In the course of the excavations of the year 1942 the sketch plans were prepared in several instalments and cleared and worked up only in the present data processing. In order to harmonize the details of the plans of the first two campaigns carried out by F. Móra and the first detail map drawn by D. Csallány the only footing was given by the find spot of grave 216: in the excavation record there is an indication to the effect that the opening of the grave and the taking of a photo of it were impeded by the fence. In the second cemetery plan several graves that were marked also in the first plan were two plans we took the N-S direction into consideration that is we brought the N point marked on the plan with the W-E oriented grave pits in agreement.⁵

The overall presentation of the results of the Makkoserdő excavations was left in the care of D. Csallány in the 1960s, yet he could not finish it in his lifetime. I had the archeological material sketched in 1968. In the course of this work I compared the material safeguarded in the Szeged Museum with the excavation records of F. Móra and D. Csallány, as well as with the inventory book. On this occasion the harness-mounts of the horse buried in grave 317 were X-rayed and restored.

In Csallány's register of Sites the Szeged-Makkoserdő cemetery is entered Under No. 865.

2. *The site of the cemetery*

The site of the cemetery is situated at the E margin of the town Szeged, outside the circular railway embankment (Fig. 1), in the area in front of Dr. Izidor Balla's Baktó plot and orchard registered under No. 286 (Fig. 2).⁶ The Makkoserdő cemetery is one of the several Avar Period cemeteries not far away from each other in the outskirts of Szeged.

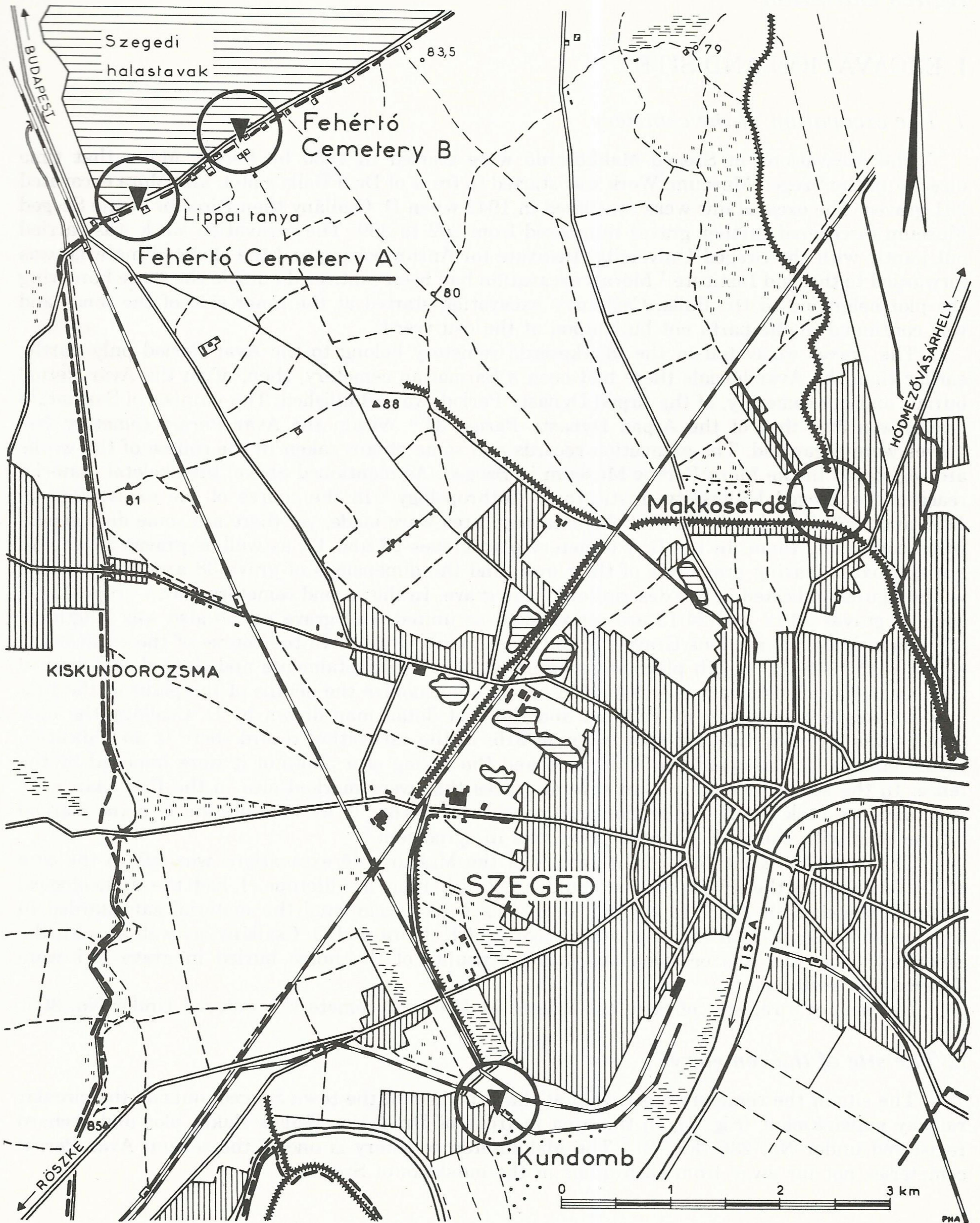

Fig. 1. Szeged-Makkoserdő. Map of the area

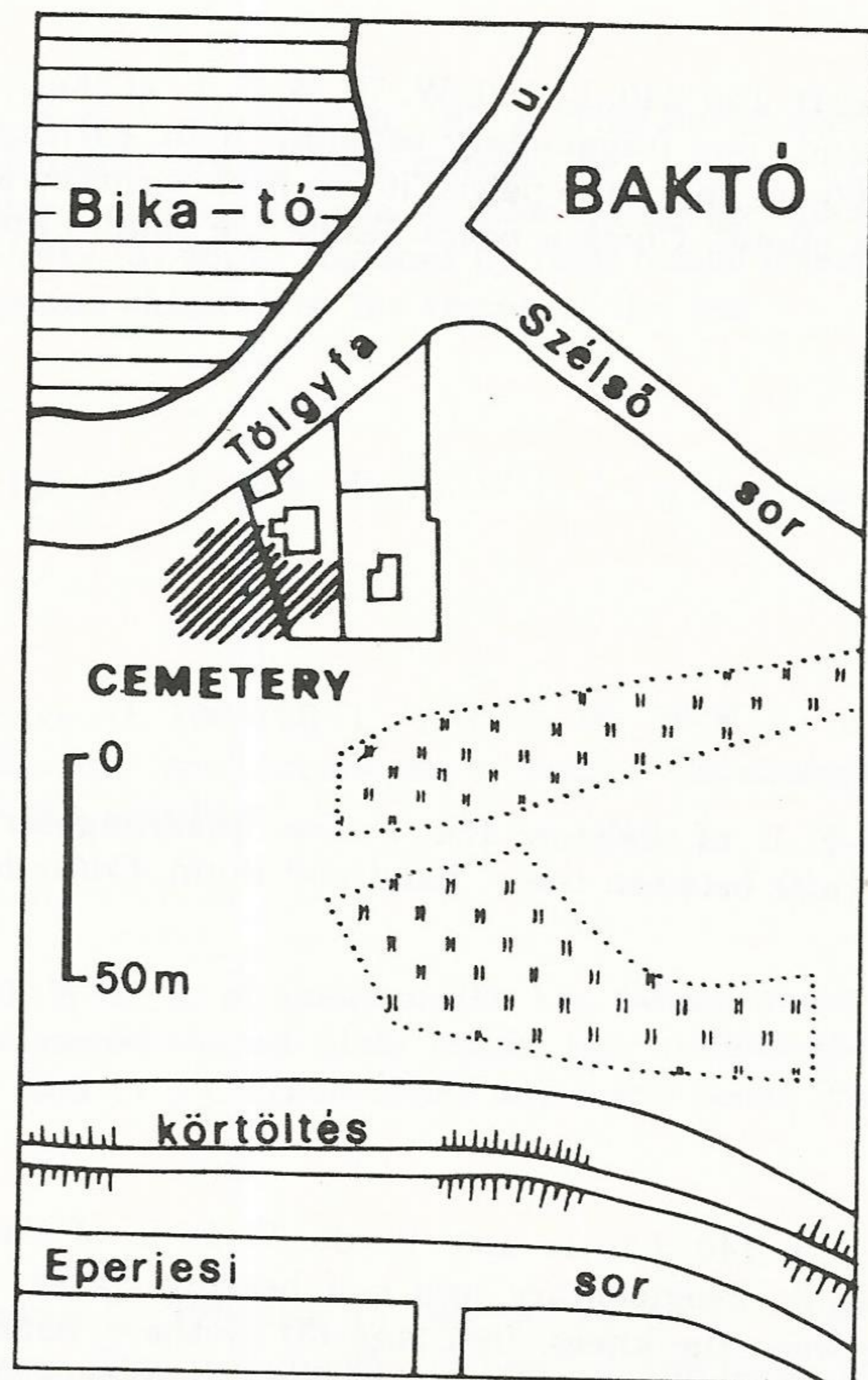

Fig. 2. Szeged-Makkoseredő. Sketch plan of the excavated area